



V-Belts



BASICS ON V-BELTS

V-Belts are flexible devices designed to transmit power based on the friction created in the sidewalls of a sheave's wedge by tension.

While the V-Belt is tightly wedged in the sheave, the friction created between the surface of the belt and the sheave gives way to transmit high torques.

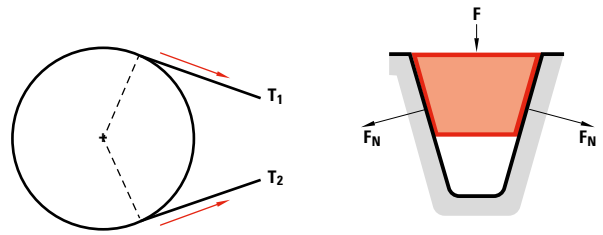

STANDARDS AND DEFINITIONS

The ISO 1081:2013 specifies the terms and definitions related to V-Belt drives, V-Belts, hexagonal belts, joint V-Belts with the corresponding V-Grooved pulleys, V-Ribbed belt drives, V-Ribbed belts with the corresponding V-Ribbed pulleys.

V-Belt, a belt with a cross section shaped roughly like a regular trapezium.

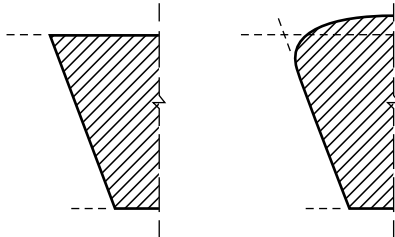

Pitch zone, the geometrical surface zone containing all the pitch lines.

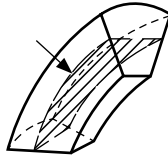

Pitch width W_p , width of the belt at its pitch zone.

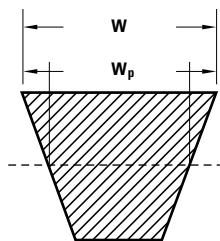

Pulleys

V-Grooved pulley, a pulley with one or more grooves obtained by rotation of a profile in the shape of a truncated or non truncated symmetrical V around the pulley axis.

Angle of pulley groove α , angle included by the sides of the groove cross-section.

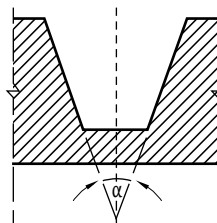

Relative height T/W_p , a non-dimensional characteristic calculated as the ratio of height to pitch width.

The approximate relative heights of the four types of V-Belts are as follows.

Narrow V-Belt: 0,9; Classical V-Belt: 0,7; Half wide V-Belt: 0,5; Wide V-Belt: 0,3.

Hexagonal belt, a belt with trapezoidal cross-section consisting of an isosceles trapezium.

Joined V-Belt, two or more equal trapezoidal V-Belts placed side by side in a definite distance and joined by a covering band.

Pitch line, a circumference line in the belt which keeps the same length when the belt is bent perpendicularly to its base.

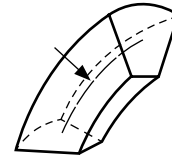

Top width W , the larger width of the trapezium outlined on a cross-section.

Height T , the height of the trapezium outlined on a cross-section.

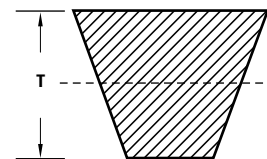

Pitch width of pulley groove W_p , width of the pulley groove which has the same dimension as the pitch width of the belt used with this pulley.

Pitch diameter d_p , diameter of the pulley at the pitch width of pulley groove.

Pitch circumference C_p , circumference of a circle with a diameter equal to the pitch diameter.

Datum¹ width W_d , groove width characterizing the groove profile.

Datum. Short notes on the datum concept.

Datum term was introduced in the ISO 1081-1980 and later in 1988 by RMAⁱ (Rubber Manufacturers Association) in their standard IP-20-1988 for the known as 'Classical belts and Sheaves'.

Previous to the introduction of the Datum System, the system used was the Pitch System which defined the pitch diameter to the outer diameter. As we have seen, the standard ISO1081:2013 defines the pitch line as a circumference line which keeps the same length when the belt is bent perpendicularly to its base.

Pitch diameter and thus the pitch length vary according the size and construction of the belt and in consequence there was not a univocal system which could be applied to the different configurations of the V-Belts, single, banded, wrapped, and raw edge.

With the introduction of the datum concept for the 'Classical belts and sheaves', the pitch diameter corresponds to the outside diameter of the pulley, thus to calculate the speed, the pitch diameter as newly defined gives a result accurate enough.

With the datum system, what was known as pitch diameter and pitch length, is replaced by the datum diameter and the datum length.

The change to a datum was influenced by the technical improvements in the belt making industry, whereas what was considered the pitch line as located in the tensile cord, by moving it higher in the belt to have higher arm momentum, the belt's pitch length varied, thus in order to accommodate the changes, the datum was created.

The datum system preserves some classic concepts while others have changed, in a way that what was formerly defined as pitch length in belts and pitch diameter in pulleys are now defined as datum length and datum diameter.

As mentioned, the pitch diameter corresponds now to the outer diameter for most of the pulleys, while the datum diameter is a bit less. Outer diameter and pitch diameter are related to the datum diameter by a set of formulasⁱⁱ.

It is important to notice that the datum system applies to the classical belts only and consequently does not apply to the Narrow or Wedge belts.

Drives

V-Belt drive, drive which consists of one or more V-Belts mounted on grooved pulleys.

Note on V-Belt lengths

The most recommended is to use the **effective length-outside**, although other terms are used in this respect as, inside, pitch and nominal defined as under:

Outside length, it can be measured by a simple tape with the belt under no tension. This reading is not precise given the fact that the outside may be flat or arched. This measure may be taken as an approximation.

Inside length, this is a very unprecise measure which is hardly used but in flat belts.

Pitch length, the length at the pitch diameter of the pulleys used. It is found by the addition of twice the center distance between two equal diameter pulleys at a specified tension to the pitch circumfe-

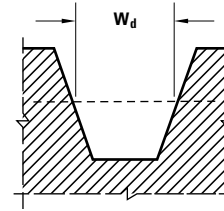

Datum length of a belt L_d , the length of a line circumscribing a V-Belt at the level of the datum diameter of the measuring pulleys whilst the V-Belt is at a specified tension.

Note 1. The datum length was previously designated as pitch length L_p .

Datum diameter d_d , diameter of the pulley at the datum width of the pulley groove.

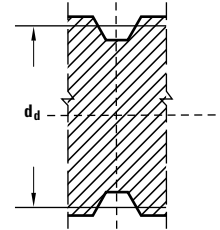

Datum circumference C_d , circumference of a circle with a diameter equal to the datum diameter.

Datum line differential b_d , radial displacement between levels of the pitch width and the datum width.

Note 1. The datum line differential is a correction term used for calculating the speed ratio when the datum line is given.

Note 2. The datum line differential is zero if the pitch zone of the V-Belt and the level of the datum width of the pulley are coincident.

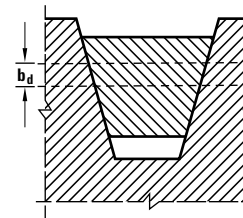

Speed ratio R , ratio of the angular velocities of the pulleys as calculated from the ratio of the pitch diameters of the pulleys, making no allowance for sleep and creep.

rence. Today, changed to datum length.

The pitch line passes near the cord line according the manufacturer's construction and cross section. This line is a base point to which refer for the effective diameter of the pulley and belt's effective length.

Effective length, length about the effective outside diameter of a pulley at a specific tension. The effective outside diameter of a pulley is measured where the groove top width is a dimension as specified by RMA, ASAE or SAE standards.

Nominal length, refers to the length and cross section of a specific belt and is used for designation only.

¹ **Datum:** Amongst two other meanings, a fixed starting point of a scale of operation, Oxford dictionary. In engineering, Datum point is a single reference point that all measurements are taken from.

ⁱ See page num 20

ⁱⁱ Outer dia= Datum dia + 2a
Pitch dia = Datum dia + 2a - 2b

Classical Profiles	Values 2a	Values 2a
A & AX	6,35 mm/0,25"	Nil
B & BX	8,89 mm/0,35"	Nil
B & BX	10,16 mm/0,40"	Nil

V-Belt construction

There are two basic constructions, Wrapped and Raw-edge.

Wrapped V-Belts named as well smooth V-Belts, the term coming from the fabric that covers the belt that gives it a uniform fine finish producing a quieter operation.

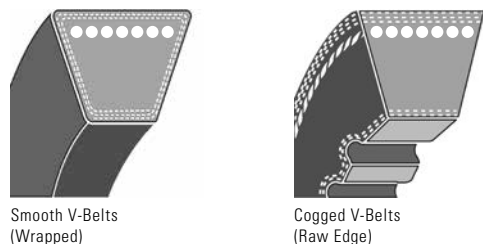

Operation as well as reducing the abrasion. One of the benefits which

may be critical in certain operations, is the slip which may prevent damage to the driven unit as the slip is acting as a clutch sort of. This may occur in case of torque spike.

The wrapped construction has another interesting feature as it is oil resistant and does not absorb humidity thus making more difficult the V-Belt to be clogged.

V-Belts raw-edge, named as well cogged after the cogs on the bottom section of the belt. The raw wedge have a higher friction factor thus have a better grip to the sheaves of the pulley, hence the higher benefit of this construction, to transmit higher horsepower at higher speeds which can be thirty per cent higher than the wrapped equivalent.

Another benefit of the raw-edge V-Belts is the higher wrapping ability, due to the cogs, around small pulleys.

V-BELTS DIN / ISO

Classical Series DIN 2215 / ISO 4184

Known as Classical Series as they were the first V-Belts to enter the power transmission.

They are offered in Wrapped and Raw Edge Cogged versions. The latter is distinguished from the former adding X to the reference model.

Although the former standard nomenclature designated the internal length L_i as the length of the belt, the ISO 4184 established the datum length as the measure to define the length of the belt.

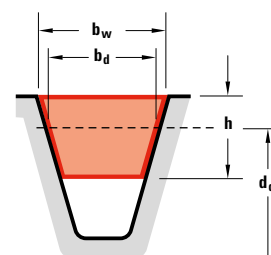

*PROFILES	5#	Y/6	8#	Z/10	A/13	B/17	20#	C/22	25	D/32#	E/40
Belt height h	3,00	4,00	5,00	6,00	8,00	11,00	12,50	14,00	16,00	20,00	25,00
Belt width b_w	5,00	6,00	8,00	10,00	13,00	17,00	20,00	22,00	25,00	32,00	40,00
Datum width b_d	4,20	5,30	6,70	8,50	11,00	14,00	17,00	19,00	21,00	27,00	32,00
**Weight	0,018	0,026	0,042	0,064	0,109	0,196	0,266	0,324	0,420	0,668	0,958
Min. Pulley datum dia	20,00	28,00	40,00	50,00	71,00	112,00	160,00	180,00	250,00	355,00	500,00

* All measures in mm. ** Kg/m. # Non Standard ISO profiles

*Program aprox. dimensions	200 to 610	295 to 865	335 to 1270	312 to 2500	437 to 5030	610 to 7140	950 to 6050	1148 to 8058	1460 to 9060	2075 to 11275	3080 to 12580
----------------------------	------------	------------	-------------	-------------	-------------	-------------	-------------	--------------	--------------	---------------	---------------

* Datum length in mm.

PROFILES	5	Y/6	8	Z/10	A/13	B/17	20	C/22	25	D/32	E/40
Base	5	6	8	10	13	17	20	22	25	32	40
Height	3	4	5	6	8	11	12,5	14	16	20	25

Height / Width ratio: 1/1,6. User's guide: Maximum allowed speed around 30 m/s. Maximum permitted frequency 1/80 Hz.

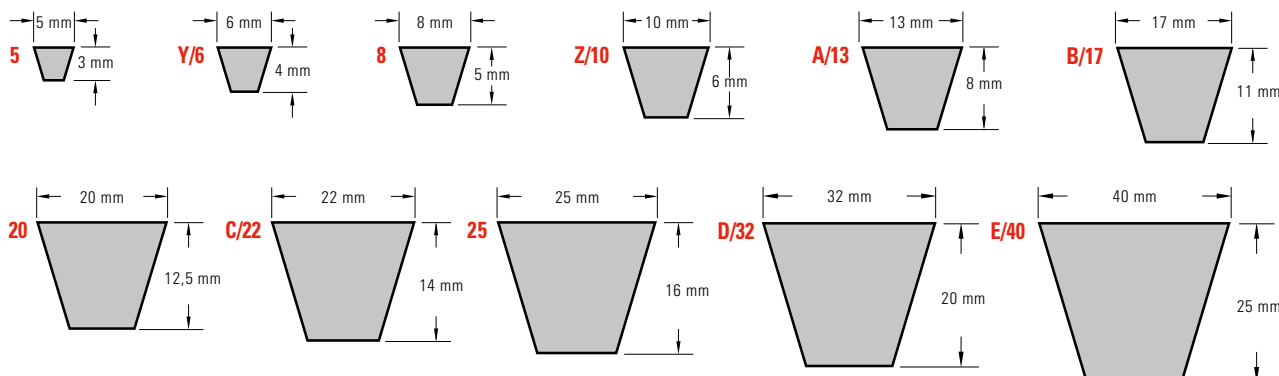

PROFILE Y/6

REFERENCE NUMBER*	DATUM LENGTH	INSIDE LENGTH
	Ld	Li
TL-Y/6-280	295	280
TL-Y/6-300	315	300
TL-Y/6-335	350	335
TL-Y/6-400	415	400
TL-Y/6-425	440	425
TL-Y/6-450	465	450
TL-Y/6-500	515	500
TL-Y/6-540	555	540
TL-Y/6-600	615	600
TL-Y/6-850	865	850

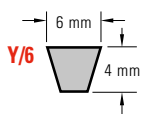

PROFILE Z/10

REFERENCE NUMBER*	DATUM LENGTH	INSIDE LENGTH
	Ld	Li
TL-Z11	312	290
TL-Z12 1/2	337	315
TL-Z14	397	375
TL-Z15	422	400
TL-Z16	447	425
TL-Z17	472	450
TL-Z18	497	475
TL-Z19	502	480
TL-Z19 1/2	522	500
TL-Z20	537	515
TL-Z20 1/2	547	525
TL-Z21	552	530
TL-Z21 1/4	562	540
TL-Z22	582	560
TL-Z23	597	575
TL-Z24	622	600
TL-Z25	652	630
TL-Z26	672	650
TL-Z27	692	670
TL-Z27 1/2	722	700
TL-Z28	732	710
TL-Z28 1/2	747	725
TL-Z29	752	730
TL-Z29 1/2	772	750
TL-Z30	787	765
TL-Z31	797	775
TL-Z31 1/2	822	800
TL-Z32	842	820
TL-Z33	847	825
TL-Z33 1/2	872	850
TL-Z34	887	865
TL-Z35	897	875
TL-Z36	922	900
TL-Z37	947	925
TL-Z38	972	950
TL-Z38 1/2	997	975
TL-Z39	1022	1000
TL-Z40	1038	1016
TL-Z40 1/2	1052	1030
TL-Z41	1063	1041
TL-Z41 1/2	1072	1050
TL-Z42	1082	1060
TL-Z43	1102	1080
TL-Z43 1/2	1122	1100
TL-Z44	1142	1120
TL-Z45	1172	1150
TL-Z46	1187	1165
TL-Z46 1/2	1202	1180
TL-Z47	1216	1194
TL-Z48	1237	1215
TL-Z48 1/2	1247	1225

REFERENCE NUMBER*	DATUM LENGTH	INSIDE LENGTH
	Ld	Li
TL-Z49	1272	1250
TL-Z50	1292	1270
TL-Z51	1317	1295
TL-Z52	1342	1320
TL-Z53	1368	1346
TL-Z54	1393	1371
TL-Z55	1422	1400
TL-Z56	1444	1422
TL-Z57	1472	1450
TL-Z58	1497	1475
TL-Z59	1522	1500
TL-Z60	1546	1524
TL-Z61	1572	1550
TL-Z62	1597	1575
TL-Z63	1622	1600
TL-Z64	1648	1626
TL-Z65	1673	1651
TL-Z66	1697	1675
TL-Z67	1722	1700
TL-Z68	1747	1725
TL-Z69	1772	1750
TL-Z70	1797	1775
TL-Z71	1822	1800
TL-Z73	1872	1850
TL-Z75	1922	1900
TL-Z78	1997	1975
TL-Z79	2022	2000
TL-Z83 1/2	2142	2120
TL-Z88	2262	2240
TL-Z93	2382	2360
TL-Z98	2522	2500

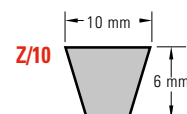

* All measures in mm.

PROFILE A/13

REFERENCE NUMBER*	DATUM LENGTH	INSIDE LENGTH
	Ld	Li
TL-A16	437	407
TL-A18	487	457
TL-A19	510	480
TL-A20	538	508
TL-A21	565	535
TL-A22	590	560
TL-A23	605	575
TL-A23 1/2	630	600
TL-A24	640	610
TL-A25	660	630
TL-A26	680	650
TL-A26 1/2	700	670
TL-A27	716	686
TL-A27 1/2	730	700
TL-A28	740	710
TL-A29	760	730
TL-A29 1/2	780	750
TL-A30	797	767
TL-A31	805	775
TL-A31 1/2	830	800
TL-A32	843	813
TL-A32 1/2	855	825
TL-A33	871	841
TL-A34	880	850
TL-A34 1/2	905	875
TL-A35	919	889
TL-A35 1/2	930	900
TL-A36	944	914
TL-A37	955	925
TL-A37 1/2	980	950
TL-A38	995	965
TL-A38 1/2	1005	975
TL-A39	1030	1000
TL-A40	1046	1016
TL-A40 1/2	1060	1030
TL-A41	1071	1041
TL-A41 1/2	1080	1050
TL-A42	1090	1060
TL-A42 1/2	1105	1075
TL-A43	1130	1100
TL-A43 1/2	1135	1105
TL-A44	1150	1120
TL-A45	1173	1143
TL-A45 1/2	1180	1150
TL-A46	1198	1168
TL-A46 1/2	1210	1180
TL-A47	1230	1200
TL-A47 1/2	1245	1215
TL-A48	1250	1220
TL-A48 1/2	1255	1225
TL-A49	1280	1250
TL-A50	1300	1270
TL-A51	1330	1300
TL-A52	1350	1320

REFERENCE NUMBER*	DATUM LENGTH	INSIDE LENGTH
	Ld	Li
TL-A53	1380	1350
TL-A54	1405	1375
TL-A55	1430	1400
TL-A56	1452	1422
TL-A57	1480	1450
TL-A58	1505	1475
TL-A59	1530	1500
TL-A60	1555	1525
TL-A61	1580	1550
TL-A62	1605	1575
TL-A63	1630	1600
TL-A64	1655	1625
TL-A65	1680	1650
TL-A66	1706	1676
TL-A67	1730	1700
TL-A68	1755	1725
TL-A69	1780	1750
TL-A70	1805	1775
TL-A71	1830	1800
TL-A72	1855	1825
TL-A73	1884	1854
TL-A74	1910	1880
TL-A75	1930	1900
TL-A76	1960	1930
TL-A77	1986	1956
TL-A78	2010	1980
TL-A79	2030	2000
TL-A80	2062	2032
TL-A81	2090	2060
TL-A82	2113	2083
TL-A83	2130	2100
TL-A83 1/2	2150	2120
TL-A84	2164	2134
TL-A84 1/2	2180	2150
TL-A85	2190	2160
TL-A86 1/2	2230	2200
TL-A87	2240	2210
TL-A88	2270	2240
TL-A89	2291	2261
TL-A90	2316	2286
TL-A91	2341	2311
TL-A92	2367	2337
TL-A93	2390	2360
TL-A94	2418	2388
TL-A95	2443	2413
TL-A96	2468	2438
TL-A97	2494	2464
TL-A98	2530	2500
TL-A100	2570	2540
TL-A102	2621	2591
TL-A104	2680	2650
TL-A105	2697	2667
TL-A107	2755	2725
TL-A108	2773	2743

REFERENCE NUMBER*	DATUM LENGTH	INSIDE LENGTH
	Ld	Li
TL-A110	2830	2800
TL-A112	2875	2845
TL-A114	2926	2896
TL-A116	2976	2946
TL-A118	3030	3000
TL-A120	3078	3048
TL-A124	3180	3150
TL-A128	3280	3250
TL-A132	3380	3350
TL-A136	3484	3454
TL-A140	3580	3550
TL-A144	3688	3658
TL-A148	3780	3750
TL-A158	4030	4000
TL-A167	4280	4250
TL-A187	4780	4750
TL-A197	5030	5000

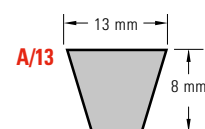

* All measures in mm.

PROFILE B/17

REFERENCE NUMBER*	DATUM LENGTH	INSIDE LENGTH
	Ld	Li
TL-B23	610	570
TL-B24	655	615
TL-B25	670	630
TL-B26	690	650
TL-B26 1/2	710	670
TL-B27	726	686
TL-B28	750	710
TL-B29	765	725
TL-B30	790	750
TL-B31	815	775
TL-B32	840	800
TL-B32 1/2	865	825
TL-B33	876	836
TL-B34	890	850
TL-B34 1/2	915	875
TL-B35	929	889
TL-B36	940	900
TL-B37	965	925
TL-B37 1/2	990	950
TL-B38	1005	965
TL-B38 1/2	1015	975
TL-B39	1040	1000
TL-B40	1056	1016
TL-B40 1/2	1070	1030
TL-B41	1080	1040
TL-B41 1/2	1090	1050
TL-B42	1100	1060
TL-B42 1/2	1115	1075
TL-B43	1130	1090
TL-B43 1/4	1140	1100
TL-B44	1160	1120
TL-B45	1190	1150
TL-B45 1/2	1203	1163
TL-B46	1215	1175
TL-B46 1/2	1220	1180
TL-B47	1240	1200
TL-B48	1255	1215
TL-B48 1/2	1265	1225
TL-B49	1290	1250
TL-B50	1315	1275
TL-B51	1340	1300
TL-B52	1360	1320
TL-B52 1/2	1375	1335
TL-B53	1390	1350
TL-B53 1/2	1400	1360
TL-B54	1412	1372
TL-B55	1440	1400
TL-B56	1462	1422
TL-B57	1490	1450
TL-B58	1513	1473
TL-B59	1540	1500
TL-B60	1565	1525
TL-B61	1590	1550
TL-B62	1615	1575

REFERENCE NUMBER*	DATUM LENGTH	INSIDE LENGTH
	Ld	Li
TL-B63	1640	1600
TL-B64	1665	1625
TL-B65	1690	1650
TL-B66	1716	1676
TL-B67	1740	1700
TL-B68	1765	1725
TL-B69	1790	1750
TL-B69 1/2	1801	1761
TL-B70	1815	1775
TL-B71	1840	1800
TL-B72	1869	1829
TL-B73	1890	1850
TL-B74	1920	1880
TL-B75	1940	1900
TL-B76	1970	1930
TL-B77	1990	1950
TL-B78	2021	1981
TL-B79	2040	2000
TL-B80	2072	2032
TL-B81	2100	2060
TL-B82	2123	2083
TL-B83	2140	2100
TL-B83 1/2	2160	2120
TL-B84	2174	2134
TL-B85	2200	2160
TL-B86	2240	2200
TL-B87	2250	2210
TL-B88	2280	2240
TL-B89	2301	2261
TL-B90	2326	2286
TL-B91	2340	2300
TL-B92	2377	2337
TL-B93	2400	2360
TL-B94	2428	2388
TL-B94 1/2	2440	2400
TL-B95	2453	2413
TL-B96	2478	2438
TL-B96 1/2	2490	2450
TL-B97	2505	2465
TL-B98	2540	2500
TL-B99	2555	2515
TL-B100	2580	2540
TL-B101	2605	2565
TL-B102	2640	2600
TL-B103	2656	2616
TL-B104	2690	2650
TL-B105	2707	2667
TL-B106	2740	2700
TL-B107	2758	2718
TL-B108	2790	2750
TL-B110	2840	2800
TL-B112	2885	2845
TL-B114	2940	2900
TL-B115	2961	2921

REFERENCE NUMBER*	DATUM LENGTH	INSIDE LENGTH
	Ld	Li
TL-B116	2990	2950
TL-B118	3040	3000
TL-B120	3088	3048
TL-B122	3139	3099
TL-B124	3190	3150
TL-B126	3240	3200
TL-B128	3290	3250
TL-B130	3342	3302
TL-B132	3390	3350
TL-B134	3444	3404
TL-B136	3490	3450
TL-B138	3545	3505
TL-B140	3590	3550
TL-B142	3640	3600
TL-B144	3698	3658
TL-B146	3740	3700
TL-B148	3790	3750
TL-B150	3850	3810
TL-B151	3890	3850
TL-B152	3901	3861
TL-B154	3952	3912
TL-B155	3990	3950
TL-B156	4002	3962
TL-B158	4040	4000
TL-B160	4104	4064
TL-B162	4155	4115
TL-B165	4240	4200
TL-B167	4290	4250
TL-B173	4434	4394
TL-B175	4490	4450
TL-B177	4540	4500
TL-B180	4612	4572
TL-B187	4790	4750
TL-B195	4993	4953
TL-B197	5040	5000
TL-B208	5340	5300
TL-B210	5374	5334
TL-B220	5640	5600
TL-B236	6040	6000
TL-B240	6136	6096
TL-B248	6340	6300
TL-B264	6740	6700
TL-B276	7040	7000
TL-B280	7140	7100

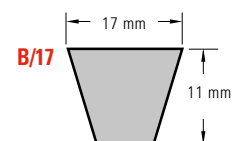

* All measures in mm.

PROFILE 20

REFERENCE NUMBER*	DATUM LENGTH	INSIDE LENGTH
	Ld	Li
TL-20-900	950	900
TL-20-1000	1050	1000
TL-20-1120	1170	1120
TL-20-1180	1230	1180
TL-20-1250	1300	1250
TL-20-1320	1370	1320
TL-20-1400	1450	1400
TL-20-1500	1550	1500
TL-20-1600	1650	1600
TL-20-1700	1750	1700
TL-20-1800	1850	1800
TL-20-1900	1950	1900
TL-20-2000	2050	2000
TL-20-2120	2170	2120
TL-20-2240	2290	2240
TL-20-2360	2410	2360
TL-20-2500	2550	2500
TL-20-2650	2700	2650
TL-20-2800	2850	2800
TL-20-3000	3050	3000
TL-20-3150	3200	3150
TL-20-3350	3400	3350
TL-20-3550	3600	3550
TL-20-3750	3800	3750
TL-20-4000	4050	4000
TL-20-4500	4550	4500
TL-20-5000	5050	5000
TL-20-6000	6050	6000

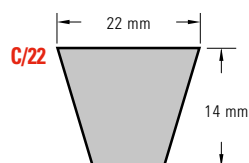
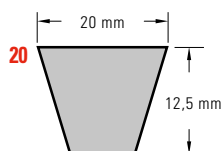

PROFILE C/22

REFERENCE NUMBER*	DATUM LENGTH	INSIDE LENGTH
	Ld	Li
TL-C43	1148	1090
TL-C47	1258	1200
TL-C48	1273	1215
TL-C49	1308	1250
TL-C51	1353	1295
TL-C52	1378	1320
TL-C53	1408	1350
TL-C54	1433	1375
TL-C55	1458	1400
TL-C56	1483	1425
TL-C57	1508	1450
TL-C58	1533	1475
TL-C59	1558	1500
TL-C60	1582	1524
TL-C61	1608	1550
TL-C62	1632	1574
TL-C63	1658	1600
TL-C65	1708	1650
TL-C66	1734	1676
TL-C67	1758	1700
TL-C68	1785	1727
TL-C69	1808	1750
TL-C70	1836	1778
TL-C71	1858	1800
TL-C72	1887	1829
TL-C73	1912	1854
TL-C74	1938	1880
TL-C75	1958	1900
TL-C76	1988	1930
TL-C77	2014	1956
TL-C78	2039	1981
TL-C79	2058	2000
TL-C80	2090	2032
TL-C81	2118	2060
TL-C82	2141	2083
TL-C83	2166	2108
TL-C83 1/2	2178	2120
TL-C84	2192	2134
TL-C85	2217	2159
TL-C86	2242	2184
TL-C87	2268	2210
TL-C88	2298	2240
TL-C89	2319	2261
TL-C90	2344	2286
TL-C92	2395	2337
TL-C93	2418	2360
TL-C94	2446	2388
TL-C95	2471	2413
TL-C96	2496	2438
TL-C96 1/2	2508	2450
TL-C97	2522	2464
TL-C98	2558	2500
TL-C99	2583	2525
TL-C100	2598	2540
TL-C101	2618	2560

REFERENCE NUMBER*	DATUM LENGTH	INSIDE LENGTH
	Ld	Li
TL-C102	2649	2591
TL-C104	2700	2642
TL-C105	2725	2667
TL-C106	2750	2692
TL-C108	2808	2750
TL-C110	2858	2800
TL-C112	2903	2845
TL-C114	2954	2896
TL-C115	2979	2921
TL-C116	3008	2950
TL-C117	3023	2965
TL-C118	3058	3000
TL-C120	3106	3048
TL-C122	3157	3099
TL-C124	3208	3150
TL-C126	3258	3200
TL-C128	3308	3250
TL-C130	3360	3302
TL-C132	3408	3405
TL-C134	3462	3404
TL-C136	3508	3450
TL-C138	3563	3505
TL-C140	3608	3550
TL-C142	3665	3607
TL-C144	3716	3658
TL-C146	3758	3700
TL-C148	3808	3750
TL-C150	3868	3810
TL-C158	4058	4000
TL-C162	4158	4100
TL-C166	4274	4216
TL-C167	4308	4250
TL-C168	4325	4267
TL-C170	4376	4318
TL-C173	4452	4394
TL-C175	4503	4445
TL-C177	4558	4500
TL-C180	4630	4572
TL-C187	4808	4750
TL-C190	4884	4826
TL-C195	5011	4953
TL-C197	5058	5000
TL-C208	5358	5300
TL-C210	5392	5334
TL-C220	5658	5600
TL-C225	5773	5715
TL-C236	6058	6000
TL-C240	6154	6096
TL-C248	6358	6300
TL-C264	6758	6700
TL-C270	6916	6858
TL-C280	7158	7100
TL-C295	7558	7500
TL-C300	7678	7620
TL-C315	8058	8000

* All measures in mm.

PROFILE 25

REFERENCE NUMBER*	DATUM LENGTH	INSIDE LENGTH
	Ld	Li
TL-25-1400	1460	1400
TL-25-1500	1560	1500
TL-25-1600	1660	1600
TL-25-1700	1760	1700
TL-25-1800	1860	1800
TL-25-1900	1960	1900
TL-25-2000	2060	2000
TL-25-2120	2180	2120
TL-25-2240	2300	2240
TL-25-2360	2420	2360
TL-25-2500	2560	2500
TL-25-2650	2710	2650
TL-25-2700	2760	2700
TL-25-2800	2860	2800
TL-25-3000	3060	3000
TL-25-3150	3210	3150
TL-25-3350	3410	3350
TL-25-3550	3610	3550
TL-25-3740	3810	3750
TL-25-4000	4060	4000
TL-25-4250	4310	4250
TL-25-4500	4560	4500
TL-25-4750	4810	4750
TL-25-5000	5060	5000
TL-25-5300	5360	5300
TL-25-5600	5660	5600
TL-25-6000	6060	6000
TL-25-6300	6360	6300
TL-25-6700	6760	6700
TL-25-7100	7160	7100
TL-25-7500	7560	7500
TL-25-8000	8060	8000
TL-25-8500	8560	8500
TL-25-9000	9060	9000

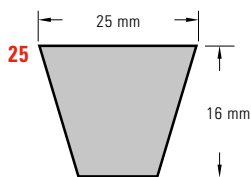

PROFILE D/32

REFERENCE NUMBER*	DATUM LENGTH	INSIDE LENGTH
	Ld	Li
TL-D79	2075	2000
TL-D98	2575	2500
TL-D104	2725	2650
TL-D110	2875	2800
TL-D118	3075	3000
TL-120	3123	3048
TL-D124	3225	3150
TL-D128	3326	3251
TL-D132	3425	3350
TL-D135	3500	3425
TL-D136	3529	3454
TL-D140	3625	3550
TL-D144	3733	3658
TL-D148	3825	3750
TL-D154	4000	3925
TL-D158	4075	4000
TL-D162	4190	4115
TL-D167	4325	4250
TL-D173	4469	4394
TL-D177	4575	4500
TL-D180	4647	4572
TL-D187	4825	4750
TL-D195	5028	4953
TL-D197	5075	5000
TL-D208	5375	5300
TL-D210	5409	5334
TL-D220	5675	5600
TL-D225	5790	5715
TL-D236	6075	6000
TL-D240	6171	6096
TL-D248	6375	6300
TL-D264	6775	6700
TL-D270	6933	6858
TL-D280	7175	7100
TL-D295	7575	7500
TL-D300	7695	7620
TL-D315	8075	8000
TL-D330	8457	8382
TL-D335	8575	8500
TL-D354	9075	9000
TL-D374	9575	9500
TL-D394	10075	10000
TL-D441	11275	11200

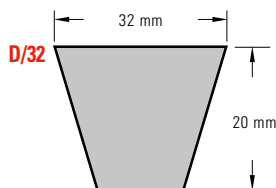

PROFILE E/40

REFERENCE NUMBER*	DATUM LENGTH	INSIDE LENGTH
	Ld	Li
TL E118	3080	3000
TL-E158	4080	4000
TL-E197	5080	5000
TL-E220	5680	5600
TL-E236	6080	6000
TL-E248	6380	6300
TL-E280	7180	7100
TL-E295	7580	7500
TL-E315	8080	8000
TL-E354	9080	9000
TL-E394	10080	10000
TL-E441	11280	11200
TL-E492	12580	12500

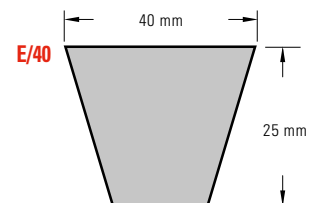

* All measures in mm.

PROFILE ZX/10

REFERENCE NUMBER*	DATUM LENGTH
	Ld
TL-ZX23	597
TL-ZX24	622
TL-ZX25	652
TL-ZX26	672
TL-ZX27	692
TL-ZX28	732
TL-ZX29	752
TL-ZX29 1/2	772
TL-ZX31 1/2	822
TL-ZX32	842
TL-ZX33	847
TL-ZX33 1/2	872
TL-ZX35	897
TL-ZX36	922
TL-ZX37	947
TL-ZX38	972
TL-ZX40	1038
TL-ZX42	1082
TL-ZX46 1/2	1202
TL-ZX52	1342
TL-ZX55	1422
TL-ZX59	1522

PROFILE AX/13

REFERENCE NUMBER*	DATUM LENGTH
	Ld
TL-AX23	605
TL-AX23 1/2	6330
TL-AX24	640
TL-AX25	660
TL-AX26 1/2	700
TL-AX27	716
TL-AX28	740
TL-AX29	760
TL-AX30	797
TL-AX31	805
TL-AX32	843
TL-AX33	871
TL-AX34	880
TL-AX35	919
TL-AX35 1/2	930
TL-AX36	944
TL-AX37	955
TL-AX37 1/2	980
TL-AX38	995
TL-AX39	1030
TL-AX40	1046
TL-AX41 1/2	1080
TL-AX42	1090
TL-AX43	1130
TL-AX44	1150
TL-AX45 1/2	1180
TL-AX46	1198
TL-AX47	1230

REFERENCE NUMBER*	DATUM LENGTH
	Ld
TL-AX48	1250
TL-AX49	1280
TL-AX50	1300
TL-AX51	1330
TL-AX52	1350
TL-AX53	1380
TL-AX54	1405
TL-AX55	1430
TL-AX56	1452
TL-AX57	1480
TL-AX58	1505
TL-AX59	1530
TL-AX62	1605
TL-AX63	1630
TL-AX67	1730
TL-AX70	1805
TL-AX71	1830
TL-AX75	1930
TL-AX79	2030
TL-AX88	2270
TL-AX93	2390
TL-AX98	2530
TL-AX104	2680
TL-AX110	2830
TL-AX118	3030
TL-AX124	3180
TL-AX132	3380

PROFILE BX/17

REFERENCE NUMBER*	DATUM LENGTH
	Ld
TL-BX23	610
TL-BX25	670
TL-BX26	690
TL-BX28	750
TL-BX29	765
TL-BX30	790
TL-BX31	815
TL-BX32	840
TL-BX33	876
TL-BX34	890
TL-BX34 1/2	915
TL-BX35	929
TL-BX36	940
TL-BX37	965
TL-BX38	1005
TL-BX39	1040
TL-BX40	1056
TL-BX41	1080
TL-BX42	1100

REFERENCE NUMBER*	DATUM LENGTH
	Ld
TL-BX43	1130
TL-BX44	1160
TL-BX45	1190
TL-BX45 1/2	1203
TL-BX46	1215
TL-BX46 1/2	1220
TL-BX47	1240
TL-BX48	1255
TL-BX49	1290
TL-BX50	1315
TL-BX51	1340
TL-BX52	1360
TL-BX53	1390
TL-BX54	1412
TL-BX55	1440
TL-BX57	1490
TL-BX58	1513
TL-BX59	1540
TL-BX61	1590

REFERENCE NUMBER*	DATUM LENGTH
	Ld
TL-BX62	1615
TL-BX63	1640
TL-BX67	BX67
TL-BX69	BX69
TL-BX71	BX71
TL-BX73	BX73
TL-BX75	BX75
TL-BX79	BX79
TL-BX88	BX88
TL-BX93	BX93
TL-BX98	BX98
TL-BX103	BX103
TL-BX104	BX104
TL-BX110	BX110
TL-BX118	BX118
TL-BX124	BX124
TL-BX132	BX132

* All measures in mm.

PROFILE CX/22

REFERENCE NUMBER*	DATUM LENGTH
	Ld
TL-CX39	1058
TL-CX43	1148
TL-CX49	1308
TL-CX52	1378
TL-CX55	1458
TL-CX59	1558
TL-CX62	1632
TL-CX67	1758

REFERENCE NUMBER*	DATUM LENGTH
	Ld
TL-CX68	1785
TL-CX71	1858
TL-CX75	1958
TL-CX79	2058
TL-CX81	2118
TL-CX85	2217
TL-CX88	2298
TL-CX90	2344

REFERENCE NUMBER*	DATUM LENGTH
	Ld
TL-CX93	2418
TL-CX96	2496
TL-CX98	2558
TL-CX110	2858
TL-CX118	3058
TL-CX124	3208
TL-CX132	3408

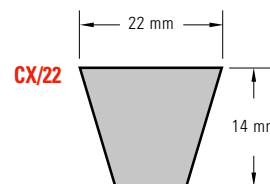
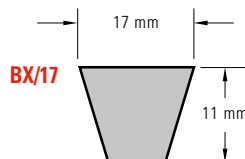
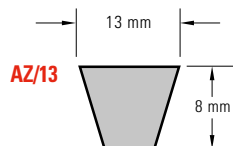
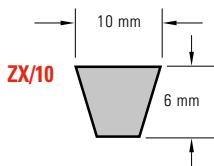

* All measures in mm.

Narrow Series DIN 7753 / ISO 4184

Known as well as Wedge Belts, they are capable to transmit up to three times the power than their equivalent of Classical belts, basically due to a greater height to width ratio, around 1/1,2. The greater height ensures a greater power transmission ability or with the same power transmission, the belt width can be smaller.

The smaller width means a lower mass which combined with higher friction means a lower centrifugal force while in operation and then can withstand higher belt speeds.

The higher thickness of the wedge belts means lower flexibility what is compensated with the cogged version which increases flexibility

making this version far more adaptable to low pulley diameters.

In regard to the Maximum permitted frequency is around 100 Hz, thus increasing the efficiency when compared with the Classical V-Belts. The maximum allowed speed is around 42 m/s.

The standard ISO establishes that the datum width is the base for the standards of the V-Belt and matching pulley sheaves, and the datum length defines the length of the belt.

Our program covers the two versions, the Wrapped and the Raw Edge Cogged which is distinguished by an X in its nomenclature.

*PROFILES	SPZ	SPA	SPB	SPC
Belt height h	8,00	10,00	13,00	18,00
Belt width b_w	9,70	12,70	16,30	22,00
Datum width b_d	8,50	11,00	14,00	19,00
Weight Kg/m	0,074	0,123	0,195	0,377
Min. Pulley datum dia	63,00	90,00	140,00	224,00

* All measures in mm

*Program aprox. dimensions	487 to 3550	732 to 4500	1250 to 8000	2000 to 12500
----------------------------	-------------	-------------	--------------	---------------

* Datum length in mm.

*PROFILES	SPZ	SPA	SPB	SPC
Belt width	9,70	12,70	16,30	22,00
Height	8,00	10,00	13,00	18,00

* Datum length in mm.

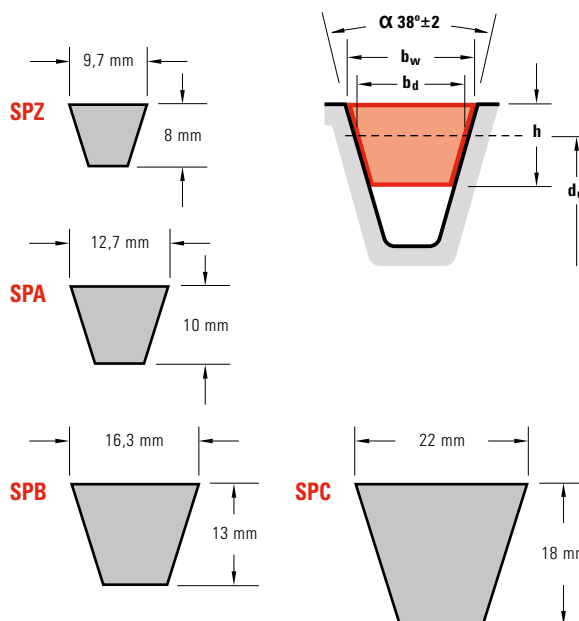

Height / Width ratio: 1/1,2. **User's guide:** Maximum allowed speed 42 m/s. Maximum allowed frequency 100 Hz.

PROFILE SPZ

*DATUM LENGTH		
Ld		
TL-SPZ 487	TL-SPZ 1047	TL-SPZ 1662
TL-SPZ 512	TL-SPZ 1060	TL-SPZ 1687
TL-SPZ 562	TL-SPZ 1077	TL-SPZ 1700
TL-SPZ 587	TL-SPZ 1087	TL-SPZ 1737
TL-SPZ 612	TL-SPZ 1112	TL-SPZ 1762
TL-SPZ 630	TL-SPZ 1120	TL-SPZ 1787
TL-SPZ 637	TL-SPZ 1137	TL-SPZ 1800
TL-SPZ 662	TL-SPZ 1162	TL-SPZ 1812
TL-SPZ 670	TL-SPZ 1180	TL-SPZ 1837
TL-SPZ 687	TL-SPZ 1187	TL-SPZ 1850
TL-SPZ 710	TL-SPZ 1202	TL-SPZ 1862
TL-SPZ 722	TL-SPZ 1212	TL-SPZ 1887
TL-SPZ 737	TL-SPZ 1237	TL-SPZ 1900
TL-SPZ 750	TL-SPZ 1250	TL-SPZ 1937
TL-SPZ 762	TL-SPZ 1262	TL-SPZ 1987
TL-SPZ 772	TL-SPZ 1287	TL-SPZ 2000
TL-SPZ 787	TL-SPZ 1312	TL-SPZ 2037
TL-SPZ 800	TL-SPZ 1320	TL-SPZ 2120
TL-SPZ 812	TL-SPZ 1337	TL-SPZ 2137
TL-SPZ 825	TL-SPZ 1347	TL-SPZ 2150
TL-SPZ 837	TL-SPZ 1362	TL-SPZ 2187
TL-SPZ 850	TL-SPZ 1387	TL-SPZ 2240
TL-SPZ 862	TL-SPZ 1400	TL-SPZ 2287
TL-SPZ 875	TL-SPZ 1412	TL-SPZ 2360
TL-SPZ 887	TL-SPZ 1437	TL-SPZ 2500
TL-SPZ 900	TL-SPZ 1462	TL-SPZ 2540
TL-SPZ 912	TL-SPZ 1487	TL-SPZ 2650
TL-SPZ 925	TL-SPZ 1500	TL-SPZ 2690
TL-SPZ 937	TL-SPZ 1512	TL-SPZ 2800
TL-SPZ 950	TL-SPZ 1537	TL-SPZ 2840
TL-SPZ 962	TL-SPZ 1562	TL-SPZ 3000
TL-SPZ 987	TL-SPZ 1587	TL-SPZ 3150
TL-SPZ 1000	TL-SPZ 1600	TL-SPZ 3350
TL-SPZ 1012	TL-SPZ 1612	TL-SPZ 3550
TL-SPZ 1024	TL-SPZ 1637	
TL-SPZ 1037	TL-SPZ 1650	

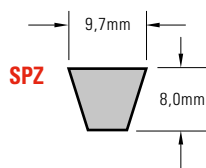

PROFILE SPA

*DATUM LENGTH		
Ld		
TL-SPA 732	TL-SPA 1432	TL-SPA 2282
TL-SPA 757	TL-SPA 1457	TL-SPA 2300
TL-SPA 782	TL-SPA 1482	TL-SPA 2307
TL-SPA 800	TL-SPA 1500	TL-SPA 2332
TL-SPA 807	TL-SPA 1507	TL-SPA 2360
TL-SPA 832	TL-SPA 1532	TL-SPA 2382
TL-SPA 850	TL-SPA 1557	TL-SPA 2432
TL-SPA 857	TL-SPA 1582	TL-SPA 2482
TL-SPA 882	TL-SPA 1600	TL-SPA 2500
TL-SPA 900	TL-SPA 1607	TL-SPA 2532
TL-SPA 907	TL-SPA 1632	TL-SPA 2582
TL-SPA 932	TL-SPA 1657	TL-SPA 2607
TL-SPA 950	TL-SPA 1682	TL-SPA 2632
TL-SPA 957	TL-SPA 1700	TL-SPA 2650
TL-SPA 982	TL-SPA 1707	TL-SPA 2682
TL-SPA 1000	TL-SPA 1732	TL-SPA 2732
TL-SPA 1007	TL-SPA 1757	TL-SPA 2782
TL-SPA 1032	TL-SPA 1782	TL-SPA 2800
TL-SPA 1060	TL-SPA 1800	TL-SPA 2832
TL-SPA 1082	TL-SPA 1807	TL-SPA 2847
TL-SPA 1107	TL-SPA 1832	TL-SPA 2882
TL-SPA 1120	TL-SPA 1857	TL-SPA 2932
TL-SPA 1132	TL-SPA 1882	TL-SPA 2982
TL-SPA 1157	TL-SPA 1900	TL-SPA 3000
TL-SPA 1180	TL-SPA 1907	TL-SPA 3032
TL-SPA 1207	TL-SPA 1932	TL-SPA 3082
TL-SPA 1232	TL-SPA 1957	TL-SPA 3150
TL-SPA 1250	TL-SPA 1982	TL-SPA 3182
TL-SPA 1257	TL-SPA 2000	TL-SPA 3282
TL-SPA 1272	TL-SPA 2032	TL-SPA 3350
TL-SPA 1282	TL-SPA 2057	TL-SPA 3382
TL-SPA 1307	TL-SPA 2082	TL-SPA 3550
TL-SPA 1320	TL-SPA 2120	TL-SPA 3750
TL-SPA 1332	TL-SPA 2132	TL-SPA 4000
TL-SPA 1357	TL-SPA 2182	TL-SPA 4250
TL-SPA 1382	TL-SPA 2207	TL-SPA 4500
TL-SPA 1400	TL-SPA 2232	
TL-SPA 1407	TL-SPA 2240	

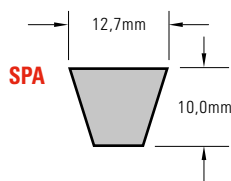

PROFILE SPB

*DATUM LENGTH	
Ld	
TL-SPB 1250	TL-SPB 2900
TL-SPB 1320	TL-SPB 3000
TL-SPB 1400	TL-SPB 3150
TL-SPB 1450	TL-SPB 3250
TL-SPB 1500	TL-SPB 3350
TL-SPB 1600	TL-SPB 3450
TL-SPB 1700	TL-SPB 3550
TL-SPB 1750	TL-SPB 3650
TL-SPB 1800	TL-SPB 3750
TL-SPB 1850	TL-SPB 3800
TL-SPB 1900	TL-SPB 4000
TL-SPB 2000	TL-SPB 4050
TL-SPB 2020	TL-SPB 4250
TL-SPB 2060	TL-SPB 4300
TL-SPB 2120	TL-SPB 4500
TL-SPB 2150	TL-SPB 4560
TL-SPB 2180	TL-SPB 4750
TL-SPB 2240	TL-SPB 4820
TL-SPB 2280	TL-SPB 5000
TL-SPB 2360	TL-SPB 5070
TL-SPB 2391	TL-SPB 5300
TL-SPB 2400	TL-SPB 5600
TL-SPB 2500	TL-SPB 6000
TL-SPB 2650	TL-SPB 6300
2TL-SPB 2680	TL-SPB 6700
TL-SPB 2800	TL-SPB 7100
TL-SPB 2840	TL-SPB 7500
TL-SPB 2850	TL-SPB 8000

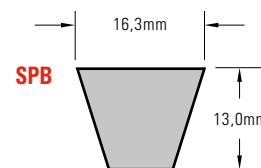

* All measures in mm.

PROFILE SPC

*DATUM LENGTH
Ld
TL-SPC 2000
TL-SPC 2120
TL-SPC 2240
TL-SPC 2360
TL-SPC 2500
TL-SPC 2650
TL-SPC 2800
TL-SPC 3000
TL-SPC 3150
TL-SPC 3350
TL-SPC 3550
TL-SPC 3750
TL-SPC 4000
TL-SPC 4250
TL-SPC 4500
TL-SPC 4750
TL-SPC 5000
TL-SPC 5300
TL-SPC 5600
TL-SPC 6000
TL-SPC 6300
TL-SPC 6700
TL-SPC 7100
TL-SPC 7500
TL-SPC 8000
TL-SPC 8500
TL-SPC 9000
TL-SPC 9500
TL-SPC 10000
TL-SPC 10600
TL-SPC 11200
TL-SPC 12500

PROFILE XPZ

*DATUM LENGTH		
Ld		
TL-XPZ 587	TL-XPZ 1000	TL-XPZ 1512
TL-XPZ 612	TL-XPZ 1012	TL-XPZ 1537
TL-XPZ 630	TL-XPZ 1037	TL-XPZ 1562
TL-XPZ 637	TL-XPZ 1060	TL-XPZ 1587
TL-XPZ 662	TL-XPZ 1077	TL-XPZ 1600
TL-XPZ 670	TL-XPZ 1087	TL-XPZ 1612
TL-XPZ 987	TL-XPZ 1112	TL-XPZ 1662
TL-XPZ 710	TL-XPZ 1120	TL-XPZ 1700
TL-XPZ 730	TL-XPZ 1137	TL-XPZ 1750
TL-XPZ 737	TL-XPZ 1162	TL-XPZ 1762
TL-XPZ 750	TL-XPZ 1180	TL-XPZ 1800
TL-XPZ 762	TL-XPZ 1187	TL-XPZ 1850
TL-XPZ 772	TL-XPZ 1202	TL-XPZ 1900
TL-XPZ 787	TL-XPZ 1212	TL-XPZ 1950
TL-XPZ 800	TL-XPZ 1337	TL-XPZ 2000
TL-XPZ 812	TL-XPZ 1250	TL-XPZ 2120
TL-XPZ 825	TL-XPZ 1262	TL-XPZ 2150
TL-XPZ 837	TL-XPZ 1287	TL-XPZ 2240
TL-XPZ 850	TL-XPZ 1312	TL-XPZ 2360
TL-XPZ 862	TL-XPZ 1320	TL-XPZ 2500
TL-XPZ 875	TL-XPZ 1337	TL-XPZ 2540
TL-XPZ 887	TL-XPZ 1362	TL-XPZ 2650
TL-XPZ 900	TL-XPZ 1387	TL-XPZ 2690
TL-XPZ 912	TL-XPZ 1400	TL-XPZ 2800
TL-XPZ 925	TL-XPZ 1412	TL-XPZ 2840
TL-XPZ 937	TL-XPZ 1437	TL-XPZ 3000
TL-XPZ 950	TL-XPZ 1432	TL-XPZ 3150
TL-XPZ 962	TL-XPZ 1487	TL-XPZ 3350
TL-XPZ 987	TL-XPZ 1500	TL-XPZ 3550

PROFILE XPA

*DATUM LENGTH		
Ld		
TL-XPA 707	TL-XPA 1207	TL-XPA 1700
TL-XPA 732	TL-XPA 1232	TL-XPA 1732
TL-XPA 757	TL-XPA 1250	TL-XPA 1750
TL-XPA 782	TL-XPA 1257	TL-XPA 1757
TL-XPA 800	TL-XPA 1272	TL-XPA 1782
TL-XPA 807	TL-XPA 1282	TL-XPA 1800
TL-XPA 832	TL-XPA 1307	TL-XPA 1832
TL-XPA 850	TL-XPA 1320	TL-XPA 1850
TL-XPA 857	TL-XPA 1332	TL-XPA 1882
TL-XPA 882	TL-XPA 1357	TL-XPA 1900
TL-XPA 900	TL-XPA 1382	TL-XPA 1932
TL-XPA 907	TL-XPA 1400	TL-XPA 1950
TL-XPA 932	TL-XPA 1432	TL-XPA 1982
TL-XPA 950	TL-XPA 1450	TL-XPA 2000
TL-XPA 957	TL-XPA 1457	TL-XPA 2120
TL-XPA 982	TL-XPA 1482	TL-XPA 2240
TL-XPA 1000	TL-XPA 1500	TL-XPA 2360
TL-XPA 1007	TL-XPA 1507	TL-XPA 2500
TL-XPA 1030	TL-XPA 1532	TL-XPA 2650
TL-XPA 1060	TL-XPA 1557	TL-XPA 2800
TL-XPA 1082	TL-XPA 1582	TL-XPA 3000
TL-XPA 1107	TL-XPA 1600	TL-XPA 3150
TL-XPA 1120	TL-XPA 1607	TL-XPA 3350
TL-XPA 1132	TL-XPA 1632	TL-XPA 3550
TL-XPA 1157	TL-XPA 1650	
TL-XPA 1180	TL-XPA 1682	

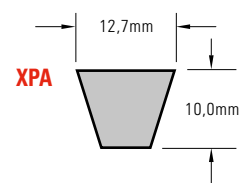
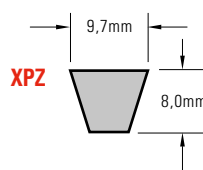
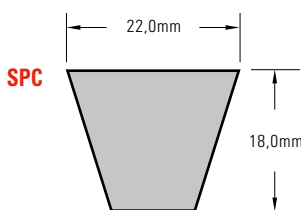

* All measures in mm.

PROFILE XPB

*DATUM LENGTH
Ld
TL-XPB 1250
TL-XPB 1320
TL-XPB 1400
TL-XPB 1500
TL-XPB 1600
TL-XPB 1700
TL-XPB 1750
TL-XPB 1800
TL-XPB 1850
TL-XPB 1900
TL-XPB 2000
TL-XPB 2020
TL-XPB 2120
TL-XPB 2150
TL-XPB 2240
TL-XPB 2280
TL-XPB 2360
TL-XPB 2400
TL-XPB 2500
TL-XPB 2650
TL-XPB 2680
TL-XPB 2800
TL-XPB 2840
TL-XPB 3000
TL-XPB 3150
TL-XPB 3350
TL-XPB 3550

PROFILE XPC

*DATUM LENGTH
Ld
TL-XPC 2000
TL-XPC 2120
TL-XPC 2240
TL-XPC 2360
TL-XPC 2500
TL-XPC 2650
TL-XPC 2800
TL-XPC 3000
TL-XPC 3150
TL-XPC 3350
TL-XPC 3550



Profile XPC

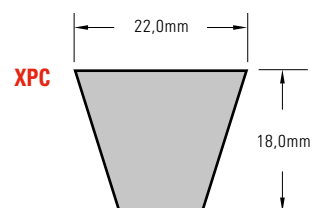
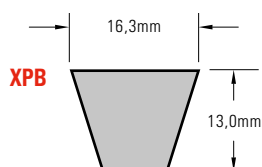

* All measures in mm.

V-BELTS ARPM / MPTA

Classical Series ARPM / MPTA IP-20

The ARPM IP-20 on Specifications for Drives Using Classical V-Belts defines the A, B, C and D Cross Sections Inch-Pound & Metric dimensions. (August 2015).

Narrow Series ARPM / MPTA IP-22

The ARPM IP-22 on Specifications for Drives Using Narrow V-Belts and Sheaves establishes the Cross Sections of 3V/3VX, 5V/5VX & 8V Inch – Pound and 9N/9NX, 15N/15NX, & 25N Metric. (August 2015).

This is the standard used in the USA which partially resembles the

DIN 7753 Part 1 / ISO 4184 as the Series 3V/9N resembles to Series SPZ and the Series 5V/15N resembles to Series SPB. Attention must be taken at the situations where the compatibility between V-Belts of one standard with Pulleys of another may be an issue, as a premature wear may affect the V-Belt.

The Cross Sections and lengths are measured in inches, with a metric equivalent. The lengths are based on the outside length and expressed in inches by ten. Thus a US standard V-Belt 5V530, stands for a V-Belt with a Cross Section 5V (5/8 x 17/32) with an outside length of 53" or if metric defined, a 15N1346 mm of outside length, standing the number 9 as the approx top width of the Cross Section in mm, while the N meaning a single V-Belt as against J meaning a multiple V-Belt.

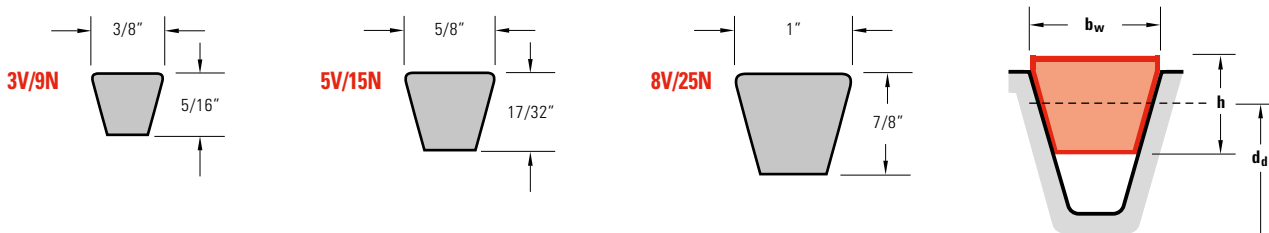

*PROFILES	3V	5V	8V
Belt height h	5/16"	17/32"	7/8"
Belt width b _w	3/8"	5/8"	1"
Weight Kg/m	0,074	0,195	0,575
Min. Pulley outside dia mm	67	151	315
Program approx. Dimensions	25 to 140	53 to 365	100 to 500

* All measures not otherwise indicated are in inches.

*PROFILES	3V/9N	5V/15N	8V/25N
Belt width	9	15	25
Belt height	8	13	23

Nomenclature. Aprox measures in mm.

*PROFILES	3V/9N	5V/15N	8V/25N
Belt width	3/8" (9,53)	5/8" (15,87)	1" (25,4)
Belt height	5/16" (7,93)	17/32"(13,49)	7/8" (22,23)

* Measures: inches (mm).

Height / Width ratio: 1/1,2.

User's guide: Maximum allowed speed 55 m/s. Maximum allowed frequency 100 Hz.

PROFILE 3V/9N

REFERENCE	*LENGTH INDICATION
	**Outside length
TL-3V250	TL-9N635
TL-3V265	TL-9N673
TL-3V280	TL-9N711
TL-3V300	TL-9N762
TL-3V315	TL-9N800
TL-3V335	TL-9N851
TL-3V355	TL-9N902
TL-3V375	TL-9N952
TL-3V400	TL-9N1016
TL-3V425	TL-9N1079
TL-3V450	TL-9N1143
TL-3V475	TL-9N1206
TL-3V500	TL-9N1270
TL-3V530	TL-9N1346
TL-3V560	TL-9N1422
TL-3V600	TL-9N1524
TL-3V630	TL-9N1600
TL-3V670	TL-9N1702
TL-3V710	TL-9N1803
TL-3V750	TL-9N1905
TL-3V800	TL-9N2032
TL-3V850	TL-9N2159
TL-3V900	TL-9N2286
TL-3V950	TL-9N2413
TL-3V1000	TL-9N2540
TL-3V1060	TL-9N2692
TL-3V1120	TL-9N2845
TL-3V1180	TL-9N2997
TL-3V1250	TL-9N3175
TL-3V1320	TL-9N3353
TL-3V1400	TL-9N3556

PROFILE 5V/15N

REFERENCE	*LENGTH INDICATION
	**Outside length
TL-5V530	TL-15N1346
TL-5V560	TL-15N1422
TL-5V600	TL-15N1524
TL-5V630	TL-15N1600
TL-5V670	TL-15N1702
TL-5V710	TL-15N1803
TL-5V750	TL-15N1905
TL-5V800	TL-15N2032
TL-5V850	TL-15N2159
TL-5V900	TL-15N2286
TL-5V950	TL-15N2413
TL-5V1000	TL-15N2540
TL-5V1060	TL-15N2692
TL-5V1120	TL-15N2845
TL-5V1180	TL-15N2997
TL-5V1250	TL-15N3175
TL-5V1320	TL-15N3353
TL-5V1400	TL-15N3556
TL-5V1500	TL-15N3810
TL-5V1600	TL-15N4064
TL-5V1700	TL-15N4318
TL-5V1800	TL-15N4572
TL-5V1900	TL-15N4826
TL-5V2000	TL-15N5080
TL-5V2120	TL-15N5385
TL-5V2240	TL-15N5690
TL-5V2360	TL-15N5994
TL-5V2500	TL-15N6350
TL-5V2650	TL-15N6731
TL-5V2800	TL-15N7112
TL-5V3000	TL-15N7620
TL-5V3150	TL-15N8001
TL-5V3350	TL-15N8509
TL-5V3350	TL-15N9017

PROFILE 8V/25N

REFERENCE	*LENGTH INDICATION
	**Outside length
TL-8V1000	TL-25N2540
TL-8V1120	TL-25N2845
TL-8V1180	TL-25N2997
TL-8V1250	TL-25N3175
TL-8V1320	TL-25N3353
TL-8V1400	TL-25N3556
TL-8V1500	TL-25N3810
TL-8V1600	TL-25N4064
TL-8V1700	TL-25N4318
TL-8V1800	TL-25N4572
TL-8V1900	TL-25N4826
TL-8V2000	TL-25N5080
TL-8V2120	TL-25N5385
TL-8V2240	TL-25N5690
TL-8V2360	TL-25N5994
TL-8V2500	TL-25N6350
TL-8V2650	TL-25N6731
TL-8V2800	TL-25N7112
TL-8V3000	TL-25N7620
TL-8V3150	TL-25N8001
TL-8V3350	TL-25N8509
TL-8V3550	TL-25N9017
TL-8V3750	TL-25N9525
TL-8V4000	TL-25N10160
TL-8V4250	TL-25N10795
TL-8V4500	TL-25N11430
TL-8V4750	TL-25N12065
TL-8V5000	TL-25N12700

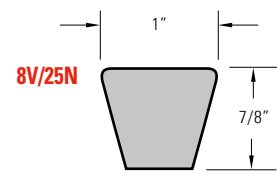
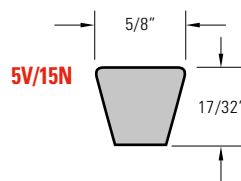
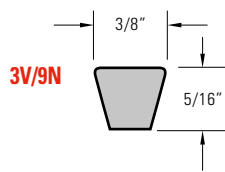

* Length in inches per ten.

** Outside length in mm.

PROFILE 3VX/9NX

REFERENCE	*LENGTH INDICATION
	**Outside length
TL-3VX250	TL-9NX635
TL-3VX265	TL-9NX673
TL-3VX280	TL-9NX711
TL-3VX300	TL-9NX762
TL-3VX315	TL-9NX800
TL-3VX335	TL-9NX851
TL-3VX355	TL-9NX902
TL-3VX375	TL-9NX952
TL-3VX400	TL-9NX1016
TL-3VX425	TL-9NX1079
TL-3VX450	TL-9NX1143
TL-3VX475	TL-9NX1206
TL-3VX500	TL-9NX1270
TL-3VX530	TL-9NX1346
TL-3VX560	TL-9NX1422
TL-3VX600	TL-9NX1524
TL-3VX630	TL-9NX1600
TL-3VX670	TL-9NX1702
TL-3VX710	TL-9NX1803
TL-3VX750	TL-9NX1905
TL-3VX800	TL-9NX2032
TL-3VX850	TL-9NX2159
TL-3VX900	TL-9NX2286
TL-3VX950	TL-9NX2413
TL-3VX1000	TL-9NX2540
TL-3VX1060	TL-9NX2692
TL-3VX1120	TL-9NX2845
TL-3VX1180	TL-9NX2997
TL-3VX1250	TL-9NX3175
TL-3VX1320	TL-9NX3353
TL-3VX1400	TL-9NX3556

PROFILE 5VX/15NX

REFERENCE	*LENGTH INDICATION
	**Outside length
TL-5VX500	TL-15NX1270
TL-5VX530	TL-15NX1346
TL-5VX560	TL-15NX1422
TL-5VX600	TL-15NX1524
TL-5VX630	TL-15NX1600
TL-5VX670	TL-15NX1702
TL-5VX710	TL-15NX1803
TL-5VX750	TL-15NX1905
TL-5VX800	TL-15NX2032
TL-5VX850	TL-15NX2159
TL-5VX900	TL-15NX2286
TL-5VX950	TL-15NX2413
TL-5VX1000	TL-15NX2540
TL-5VX1060	TL-15NX2692
TL-5VX1120	TL-15NX2845
TL-5VX1180	TL-15NX2997
TL-5VX1250	TL-15NX3175
TL-5VX1320	TL-15NX3353
TL-5VX1400	TL-15NX3556



Profile 5VX / 15NX

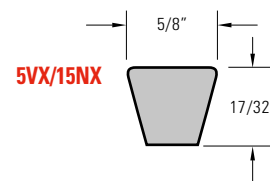
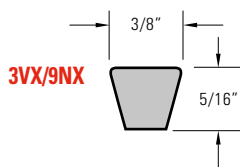

* Length in inches per ten.
 ** Outside length in mm.

DOUBLE V-BELTS DIN 7722 / ISO 5289; RMA / MPTA IP-21

They are constructed under the Standards DIN 7722 / ISO 5289 and the equivalent in US RMA / MPTA IP-21.

Standard DIN 7722 / ISO 5289: Endless hexagonal belts for agricultural machinery and groove sections of corresponding pulleys.

Standard RMA / MPTA IP-21: Specifications for Drives Using Double-V (Hexagonal) Belt. Part I – Specifications in Inch-Pound Dimensions: AA, BB, CC Cross Sections.

Named as well as Hex Belts and Double angle V-Belts has the ability to transmit power on multiple shafts.

The cross section is an hexagon built up of two trapezoids whereas the tension cord is placed right in the middle what confers to the belt a high flexibility making it ideal to engage pulleys in the same plane but different directions. Specially indicated for serpentine applications demanding reversal rotation in drive shafts.

The nominal and effective length of the Double V-Belt is measured at the outer diameter of the matching pulley, which coincides, with the length of the belt at the middle.

Available in wrapped version.

*PROFILES	AA	BB	CC
Belt height h	10,00	13,00	17,00
Belt width b_w	13,00	17,00	22,00
Weight Kg/m	0,150	0,250	0,440
Min. Pulley outside dia mm	80,00	125,00	224,00
**Program aprox. Dimensions	1350 to 3305	1345 to 7655	2015 to 10725

* All measures in mm.
** Effective length in mm.

*PROFILES		AA	BB	CC
Standard DIN 7722 / ISO 5289	Belt width b_w mm	13,00	17,00	22,00
	Belt height h mm	10,00	13,00	17,00
Standard RMA / MPTA IP-S1	Belt width b_w inch	1/2	21/32	7/8
	Belt height h inch	13/32	17/32	11/16

User's guide: Maximum allowed speed 30 m/s.

Nomenclature: The product reference consists of an alpha number string, where the two letters correspond to the profiles, AA, BB or CC plus two a maximum of three digits expressed in inches, corresponding to the length of the belt at the outside diameter of the engaged pulley.

A Double V-Belt coded TL-BB173 means a Double V-Belt of a BB profile with a length of 173". The corresponding lengths in mm do not translate exactly but are near to. The length in mm in this case is 4470 while the exact translation should be 4394. This is due to the standard ISO uses their own length in rounded mm figures.

The reason for this nomenclature is for the sake of having the maximum interchangeability with the Double V-Belts constructed under the standard ASAE S211 on V-Belt and V Ribbed Belt Drives for Agricultural machines which recollects the definitions on pulleys and belts. The V-Belt drive under this standard is for exclusive use in agricultural equipment and the length designation is the internal length in inches.

In consequence, a length conversion factors are implemented as given:
Profile AA Shortcode in mm plus 53 mm.

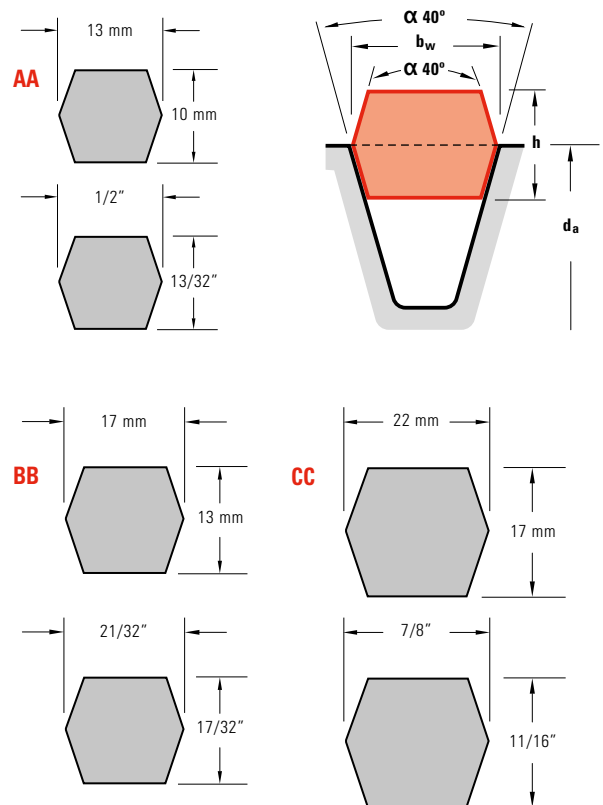

- Profile BB** Shortcode in mm plus 74 mm. Up to Shortcode 210. Shortcode in mm plus 36 mm. From 210 Shortcode and above.
- Profile CC** Shortcode in mm plus 107mm. Up to Shortcode 210. Shortcode in mm plus 56 mm. From 210 Shortcode and above.
- Profile DD** Shortcode in mm plus 132 mm. Up to 210 Shortcode 210. Shortcode in mm plus plus 69 mm. From 210 Shortcode and above.

Composing the Double V-Belt TL-BB 173, the length in mm is the 173 inches expresses in mm, i.e., 4394 mm plus the adjustment of 74 mm, thus 4468, rounded off to 4470.



PROFILE AA

BELT REFERENCE	*EFFECTIVE LENGTH
TL-AA51	1350
TL-AA60	1580
TL-AA61	1600
TL-AA68	1780
TL-AA69	1805
TL-AA71	1855
TL-AA75	1955
TL-AA77	2010
TL-AA80	2085
TL-AA81	2110
TL-AA85	2210
TL-AA90	2340
TL-AA91	2365
TL-AA95	2465
TL-AA96	2490
TL-AA105	2720
TL-AA108	2800
TL-AA112	2895
TL-AA116	3000
TL-AA120	3100
TL-AA128	3305

PROFILE BB

BELT REFERENCE	*EFFECTIVE LENGTH
TL-BB50	1345
TL-BB60	1600
TL-BB75	1980
TL-BB81	2130
TL-BB84	2210
TL-BB85	2235
TL-BB90	2360
TL-BB97	2540
TL-BB105	2740
TL-BB112	2920
TL-BB118	3070
TL-BB120	3125
TL-BB121	3150
TL-BB128	3325
TL-BB144	3735
TL-BB154	4000
TL-BB155	4010
TL-BB158	4090
TL-BB173	4470
TL-BB174	4495
TL-BB180	4645
TL-BB184	4750
TL-BB190	4900
TL-BB195	5030
TL-BB210	5410
TL-BB240	6135
TL-BB270	6895
TL-BB300	7655

PROFILE CC

BELT REFERENCE	*EFFECTIVE LENGTH
TL-CC75	2015
TL-CC81	2165
TL-CC85	2265
TL-CC86	2290
TL-CC90	2395
TL-CC96	2545
TL-CC105	2775
TL-CC112	2995
TL-CC120	3155
TL-CC128	3360
TL-CC144	3765
TL-CC153	4000
TL-CC158	4120
TL-CC162	4225
TL-CC173	4500
TL-CC180	4680
TL-CC193	5000
TL-CC195	5060
TL-CC210	5440
TL-CC234	6000
TL-CC240	6155
TL-CC270	6915
TL-CC300	7675
TL-CC313	8000
TL-CC330	8440
TL-CC360	9200
TL-CC390	9965
TL-CC420	10725

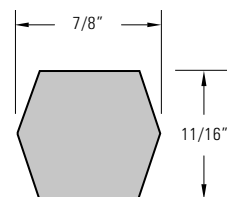
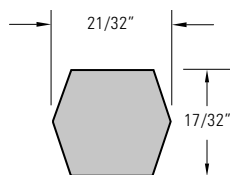
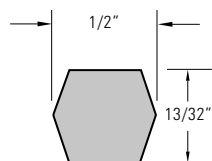
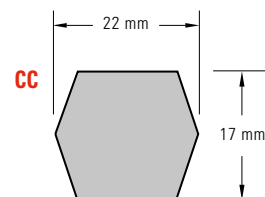
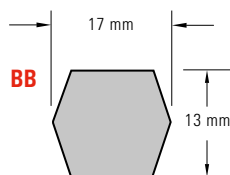
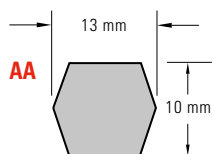

* Effective length in mm.

VARIABLE SPEED BELTS

This type of belts are designed for variable speed transmissions covering a wide range of driven speeds.

The construction of this type of belts is raw edged cogged which confers to the belt, a high transmission power, a good speed control, smooth running, good flexibility in the movement direction and a good operative life. The height/width ratio is over 1:2.

Used in a variety of applications as, in gearboxes, machine tools, agricultural combines and others.

They are constructed under the Standards:

DIN 7719-1 / ISO 1604 Endless wide V-Belts for industrial speed changers. V-Belts and groove profiles for corresponding pulleys.

They specify the main dimensions of V-Belts and the groove profiles of corresponding fixed or variable diameter pulleys.

RMA IP-25 Specifications for drives using variable Speed V-Belts.

Variable V-Belts DIN 7719-1 / ISO 1604

The nomenclature of the variable V-Belts under this standard may be a bit misleading, thus a careful attention must be taken at the time of identifying these.

It is formed of two sizes, the flat measure in mm x the height measure in mm and the Datum length as the ISO standard establishes. There are certain measures to which the ISO standard assigns the letter W.

These in particular are identified as well the section measures by W plus the width in rounded-off mm.

The table next, displays the profiles and nomenclature.



*PROFILES	13x6	17x6	21x7	22x8	26x8	28x8	30x10	32x10	36x12	37x10	42x13	47x13	52x16	55x16	65x20	70x20
Flat top width w	13	17	21	22	26	28	30	32	36	37	42	47	52	55	65	70
Height h	6	6	7	8	8	8	10	10	12	10	13	13	16	16	20	20
Nomenclature	13 x 6	W16	W17	22 x 8	W25	28 x 8	30 x 10	W31,5	36 x 12	37 x 10	W40	47 x 13	W50	55 x 16	W63	70 x 20
Angle α°	26	26	26	26	26	26	26	26	30	30	30	30	30	30	30	30

* All measures in mm.

The inside, datum and outside lengths are related by the following relation which is further displayed in the table.

Addition to the datum length to obtain the external length Ad_e :

$$Ad_e = \text{Outside length} - \text{Datum length}$$

Addition to internal length to obtain the datum length Ad_i :

$$Ad_i = \text{Datum length} - \text{Internal length}$$

*PROFILE w x h	13x6	17x6	21x7	22x8	26x8	28x8	30x10	32x10	36x12	37x10	42x13	47x13	52x16	55x16	65x20	70x20
Ad_i	29	29	33	38	38	38	47	47	56	47	61	61	75	75	94	94
Ad_e	9	9	11	12	12	12	16	16	19	16	21	21	25	25	31	31

* All measures in mm.

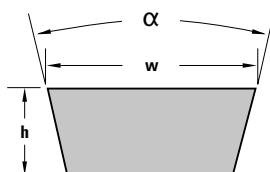

PROFILE 13 X 6

*REFERENCE NUMBER	**DATUM LENGTH
TL-V13 x 6-425	455
TL-V13 x 6-500	530
TL-V13 x 6-525	555
TL-V13 x 6-550	580
TL-V13 x 6-675	705
TL-V13 x 6-700	730
TL-V13 x 6-725	755
TL-V13 x 6-750	780
TL-V13 x 6-775	805
TL-V13 x 6-900	930

PROFILE 17 X 5

*REFERENCE NUMBER	**DATUM LENGTH
TL-W16-560	560
TL-W16-600	600
TL-W16-630	630
TL-W16-710	710
TL-W16-800	800
TL-W16-900	900
TL-W16-1000	1000

PROFILE 21 X 6,5

*REFERENCE NUMBER	**DATUM LENGTH
TL-W20-560	560
TL-W20-630	630
TL-W20-640	640
TL-W20-710	710
TL-W20-800	800
TL-W20-900	900
TL-W20-1000	1000
TL-W20-1120	1120
TL-W20-1250	1250

PROFILE 22 X 8

*REFERENCE NUMBER	**DATUM LENGTH
TL-V22 x 8-500	540
TL-V22 x 8-525	565
TL-V22 x 8-550	590
TL-V22 x 8-575	615
TL-V22 x 8-600	640
TL-V22 x 8-610	650
TL-V22 x 8-625	665
TL-V22 x 8-650	690
TL-V22 x 8-675	715
TL-V22 x 8-700	740
TL-V22 x 8-725	765
TL-V22 x 8-750	790
TL-V22 x 8-800	840
TL-V22 x 8-850	890
TL-V22 x 8-900	940
TL-V22 x 8-950	990
TL-V22 x 8-1000	1040
TL-V22 x 8-1060	1100
TL-V22 x 8-1120	1160
TL-V22 x 8-1180	1220
TL-V22 x 8-1250	1290
TL-V22 x 8-1320	1360
TL-V22 x 8-1400	1440
TL-V22 x 8-1500	1540
TL-V22 x 8-1600	1640
TL-V22 x 8-2000	2040



PROFILE 26 X 8

*REFERENCE NUMBER	**DATUM LENGTH
TL-W25-690	690
TL-W25-710	710
TL-W25-750	750
TL-W25-790	790
TL-W25-800	800
TL-W25-900	900
TL-W25-1000	1000
TL-W25-1120	1120
TL-W25-1250	1250
TL-W25-1400	1400
TL-W25-1600	1600

PROFILE 28 X 8

*REFERENCE NUMBER	**DATUM LENGTH
TL-V28 x 8-650	690
TL-V28 x 8-700	740
TL-V28 x 8-750	790
TL-V28 x 8-800	840
TL-V28 x 8-850	890
TL-V28 x 8-900	940
TL-V28 x 8-950	990
TL-V28 x 8-1000	1040
TL-V28 x 8-1060	1100
TL-V28 x 8-1120	1160
TL-V28 x 8-1180	1220
TL-V28 x 8-1250	1290
TL-V28 x 8-1320	1360
TL-V28 x 8-1400	1440
TL-V28 x 8-1500	1540
TL-V28 x 8-1600	1640
TL-V28 x 8-1700	1740

PROFILE 30 X 10

*REFERENCE NUMBER	**DATUM LENGTH
TL-V30 x 10-650	700
TL-V30 x 10-665	715
TL-V30 x 10-700	750
TL-V30 x 10-800	850
TL-V30 x 10-850	900
TL-V30 x 10-875	925
TL-V30 x 10-900	950
TL-V30 x 10-950	1000
TL-V30 x 10-1000	1050
TL-V30 x 10-1035	1085
TL-V30 x 10-1050	1100
TL-V30 x 10-1120	1170
TL-V30 x 10-1200	1250
TL-V30 x 10-1320	1370
TL-V30 x 10-1340	1390
TL-V30 x 10-1500	1550
TL-V30 x 10-1600	1650

PROFILE 33 X 10

*REFERENCE NUMBER	**DATUM LENGTH
TL-W31,5-800	800
TL-W31,5-840	840
TL-W31,5-870	870
TL-W31,5-900	900
TL-W31,5-950	950
TL-W31,5-1000	1000
TL-W31,5-1050	1050
TL-W31,5-1120	1120
TL-W31,5-1250	1250
TL-W31,5-1400	1400
TL-W31,5-1600	1600
TL-W31,5-1800	1800
TL-W31,5-2000	2000

* Inside length mm.
** Datum length mm.

PROFILE 36 X 12

*REFERENCE NUMBER	**DATUM LENGTH
TL-V36 x 12-700	755
TL-V36 x 12-725	780
TL-V36 x 12-800	855
TL-V36 x 12-850	905
TL-V36 x 12-900	955
TL-V36 x 12-950	1005
TL-V36 x 12-1000	1055
TL-V36 x 12-1060	1115
TL-V36 x 12-1120	1175
TL-V36 x 12-1180	1235
TL-V36 x 12-1250	1305
TL-V36 x 12-1320	1375
TL-V36 x 12-1400	1455
TL-V36 x 12-1500	1555
TL-V36 x 12-1600	1655
TL-V36 x 12-1700	1755
TL-V36 x 12-1800	1855
TL-V36 x 12-2000	2055
TL-V36 x 12-2120	2175

PROFILE 37 X 10

*REFERENCE NUMBER	**DATUM LENGTH
TL-V37 x 10-600	650
TL-V37 x 10-650	700
TL-V37 x 10-675	725
TL-V37 x 10-750	800
TL-V37 x 10-800	850
TL-V37 x 10-850	900
TL-V37 x 10-900	950
TL-V37 x 10-950	1000
TL-V37 x 10-1000	1050
TL-V37 x 10-1060	1110
TL-V37 x 10-1120	1170
TL-V37 x 10-1180	1230
TL-V37 x 10-1250	1300
TL-V37 x 10-1320	1370
TL-V37 x 10-1400	1450
TL-V37 x 10-1500	1550
TL-V37 x 10-1600	1650
TL-V37 x 10-1700	1750
TL-V37 x 10-1800	1850
TL-V37 x 10-1900	
TL-V37 x 10-2000	
TL-V37 x 10-2240	

PROFILE 42 X 13

*REFERENCE NUMBER	**DATUM LENGTH
TL-W40-1060	1060
TL-W40-1100	1100
TL-W40-1120	1120
TL-W40-1180	1180
TL-W40-1250	1250
TL-W40-1400	1400
TL-W40-1600	1600
TL-W40-1660	1660
TL-W40-1800	1800
TL-W40-2000	2000
TL-W40-2240	2240
TL-W40-2500	2500

PROFILE 47 X 13

*REFERENCE NUMBER	**DATUM LENGTH
TL-V47 x 13-900	1000
TL-V47 x 13-950	1010
TL-V47 x 13-1000	1060
TL-V47 x 13-1060	1120
TL-V47 x 13-1120	1180
TL-V47 x 13-1180	1240
TL-V47 x 13-1250	1310
TL-V47 x 13-1320	1380
TL-V47 x 13-1400	1460
TL-V47 x 13-1500	1560
TL-V47 x 13-1600	1660
TL-V47 x 13-1700	1760
TL-V47 x 13-1800	1860
TL-V47 x 13-1900	1960
TL-V47 x 13-2000	2060
TL-V47 x 13-2240	2300

PROFILE 52 X 16

*REFERENCE NUMBER	**DATUM LENGTH
TL-W50-1250	1250
TL-W50-1400	1400
TL-W50-1600	1600
TL-W50-1800	1800
TL-W50-2000	2000
TL-W50-2240	2240
TL-W50-2500	2500
TL-W50-2800	2800
TL-W50-3150	3150

PROFILE 55 X 16

*REFERENCE NUMBER	**DATUM LENGTH
TL-V55 x 16-1180	1255
TL-V55 x 16-1250	1325
TL-V55 x 16-1400	1475
TL-V55 x 16-1600	1675
TL-V55 x 16-18700	1775
TL-V55 x 16-1800	1875
TL-V55 x 16-2000	2075
TL-V55 x 16-2240	2315

PROFILE 65 X 20

*REFERENCE NUMBER	**DATUM LENGTH
TL-W63-1600	1600
TL-W63-1800	1800
TL-W63-2000	2000
TL-W63-2240	2240
TL-W63-2500	2500
TL-W63-2800	2800
TL-W63-3150	3150
TL-W63-3550	3550

PROFILE 70 X 20

*REFERENCE NUMBER	**DATUM LENGTH
TL-V70 x 20-1320	1415
TL-V70 x 20-1400	1495
TL-V70 x 20-1445	1540
TL-V70 x 20-1500	1595
TL-V70 x 20-1600	1695
TL-V70 x 20-1700	1795
TL-V70 x 20-1800	1895
TL-V70 x 20-1900	1995
TL-V70 x 20-2000	2095
TL-V70 x 20-2120	2210
TL-V70 x 20-2240	2330
TL-V70 x 20-2360	2450
TL-V70 x 20-2500	2590
TL-V70 x 20-2800	2890

* Inside length mm.
** Datum length mm.

BANDED V-BELTS

A Banded V-Belt consists of a number of single belts joint together with a continuous tie-band with different configurations.

They are indicated on situations where belt vibration or belt whip do not perform when multiple V-Belts are used especially in cases of long belt spans or pulsating loads which the belts turn over and eventually jump out. Their configuration prevents using multiple belts as matched sets.

They are constructed under the same standards as the individual components.

Our program covers:

1.- DIN / ISO

The Classical Belts Profiles (DIN 2215 / ISO 4184) A,B,C in Wrapped version, and AX, BX and CX in Raw Edge Cogged version.

The Wedge Belts Profiles (DIN 7753 / ISO 4184), SPZ, SPA, SPB, SPC in Wrapped version and XPZ, XPA in Raw Edge Cogged version.

2.- ARPM / MPTA Standard

The Profiles (ARPM / MPTA IP-22) 3V / 9J, 5V / 15J, 8V / 25J in Wrapped version and 3VX / 9JX, 5VX / 15JX in Raw Edge Cogged version.

3.- ISO 8419 specifies the standard effective lengths, their tolerances, the center distance variations, the conditions for measuring the effective length and the designation and marking of the narrow V-Belts. Then, 9N/J for pulley grooves of effective width 8,89 mm, 15N/J for pulley grooves of effective width 15,2 mm and 25N/J for pulley grooves of effective width 25,4 mm. The reference is designed by an alpha number string with the number 9, 15 or 25 followed by the letter N to denote a single belt or J for joined banded belt. The addition of the letter X to J indicates a raw-edge cogged construction .

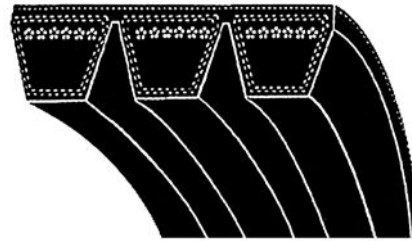

*PROFILES	A	B	C	SPZ	SPA	SPB	SPC	3V/9J	5V/15J	8V/25J	3VX/9JX	5VX/15JX
Belt height s	8,00	11,00	14,00	8,00	10,00	13,00	18,00	8,00	13,00	23,00	8,00	13,00
Belt width b_w	13,00	17,00	22,00	9,70	12,70	16,30	22,00	9,00	15,00	25,00	9,00	15,00
Belt total height h	10,00	13,00	16,00	10,50	12,50	15,50	22,50	10,00	15,00	25,50	10,00	15,00
Belt center distance $\pm 0,3 e$	15,00	19,00	25,50	12,00	15,00	19,00	25,50	10,30	17,50	28,60	10,30	17,50
#Program dimension	1200 to	1778 to	2498 to	1400 to	1400 to	2000 to	3000 to	850 to	500 to	1000 to	630 to	1270 to
	5477	5004	5334	3550	4500	8000	12500	3550	9000	15250	3550	5080

* All measures in mm. # A, B & C: Inside length Li. SPZ, SPA, SPB & SPC: Datum length Ld. 3V/9J, 5V/15J, 8V/25J, 3VX/9JX, 5VX/15JX: Outside length.

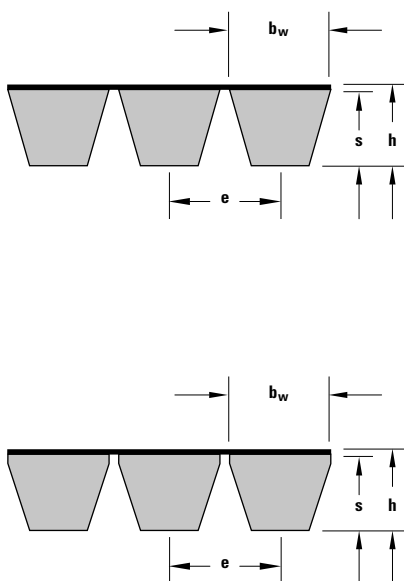

Profile 15J3C

PROFILE A

*REFERENCE NUMBER	INSIDE LENGTH L _i
TL-A47	1200
TL-A51	1300
TL-A56	1422
TL-A57	1450
TL-A59	1500
TL-A64	1625
TL-A67	1700
TL-A71	1800
TL-A75	1900
TL-A79	2000
TL-A88	2240
TL-A98	2500
TL-A100	2540
TL-A104	2650
TL-A112	2845
TL-A120	3048
TL-A128	3250
TL-A144	3658
TL-A158	4000
TL-A167	4250
TL-A187	4750
TL-A197	5000
TL-A210	5334
TL-A217	5477

PROFILE B

*REFERENCE NUMBER	INSIDE LENGTH L _i
TL-B70	1778
TL-B71	1803
TL-B72	1829
TL-B73	1854
TL-B74	1880
TL-B75	1905
TL-B76	1930
TL-B78	1981
TL-B79	2007
TL-B80	2032
TL-B81	2057
TL-B82	2083
TL-B83	2108
TL-B84	2134
TL-B85	2159
TL-B86	2184
TL-B87	2210
TL-B88	2235
TL-B89	2261
TL-B90	2286
TL-B91	2311
TL-B92	2337
TL-B93	2362
TL-B94	2368
TL-B95	2413
TL-B96	2438
TL-B97	2464
TL-B98	2489
TL-B99	2515
TL-B100	2540
TL-B102	2591
TL-B104	2642
TL-B105	2667
TL-B106	2692
TL-B107	2718
TL-B108	2743
TL-B110	2794
TL-B112	2845
TL-B114	2896

PROFILE C

*REFERENCE NUMBER	INSIDE LENGTH L _i
TL-C98	2498
TL-C99	2515
TL-C100	2540
TL-C101	2565
TL-C102	2591
TL-C104	2642
TL-C105	2667
TL-C106	2692
TL-C108	2743
TL-C110	2794
TL-C112	2845
TL-C115	2921
TL-C118	2997
TL-C120	3048
TL-C124	3150
TL-C128	3251
TL-C130	3302
TL-C134	3304
TL-C136	3454
TL-C140	3556
TL-C142	3607
TL-C144	3658
TL-C148	3759
TL-C153	3886
TL-C158	4013
TL-C160	4064
TL-C165	4191
TL-C166	4216
TL-C168	4267
TL-C173	4394
TL-C180	4572
TL-C195	4953
TL-C210	5334

* Effective length in mm.

PROFILE SPZ

*REFERENCE NUMBER	DATUM LENGTH L_d
TL-SPZ1400	1400
TL-SPZ1500	1500
TL-SPZ1600	1600
TL-SPZ1700	1700
TL-SPZ1800	1800
TL-SPZ1900	1900
TL-SPZ2000	2000
TL-SPZ2120	2120
TL-SPZ2240	2240
TL-SPZ2360	2360
TL-SPZ2500	2500
TL-SPZ2650	2650
TL-SPZ2800	2800
TL-SPZ3000	3000
TL-SPZ3150	3150
TL-SPZ3350	3350
TL-SPZ3550	3550

PROFILE SPA

*REFERENCE NUMBER	INSIDE LENGTH L_d
TL-SPA1400	1400
TL-SPA1500	1500
TL-SPA1600	1600
TL-SPA1700	1700
TL-SPA1800	1800
TL-SPA1900	1900
TL-SPA2000	2000
TL-SPA2120	2120
TL-SPA2240	2240
TL-SPA2360	2360
TL-SPA2500	2500
TL-SPA2650	2650
TL-SPA2800	2800
TL-SPA3000	3000
TL-SPA3150	3150
TL-SPA3350	3350
TL-SPA3550	3550
TL-SPA3750	3750
TL-SPA4000	4000
TL-SPA4250	4250
TL-SPA4500	4500

PROFILE SPB

*REFERENCE NUMBER	INSIDE LENGTH L_d
TL-SPB2000	2000
TL-SPB2120	2120
TL-SPB2240	2240
TL-SPB2360	2360
TL-SPB2500	2500
TL-SPB2650	2650
TL-SPB2800	2800
TL-SPB3000	3000
TL-SPB3150	3150
TL-SPB3350	3350
TL-SPB3550	3550
TL-SPB3750	3750
TL-SPB4000	4000
TL-SPB4250	4250
TL-SPB4500	4500
TL-SPB4750	4750
TL-SPB5000	5000
TL-SPB5300	5300
TL-SPB5600	5600
TL-SPB6000	6000
TL-SPB6300	6300
TL-SPB6700	6700
TL-SPB7100	7100
TL-SPB7500	7500
TL-SPB8000	8000

PROFILE SPC

*REFERENCE NUMBER	INSIDE LENGTH L_d
TL-SPC3000	3000
TL-SPC3150	3150
TL-SPC3350	3350
TL-SPC3550	3550
TL-SPC3750	3750
TL-SPC4000	4000
TL-SPC4250	4250
TL-SPC4500	4500
TL-SPC4750	4750
TL-SPC5000	5000
TL-SPC5300	5300
TL-SPC5600	5600
TL-SPC6000	6000
TL-SPC6300	6300
TL-SPC6700	6700
TL-SPC7100	7100
TL-SPC7500	7500
TL-SPC8000	8000
TL-SPC8500	8500
TL-SPC9000	9000
TL-SPC9500	9500
TL-SPC10000	10000
TL-SPC10600	10600
TL-SPC11200	11200
TL-SPC11800	11800
TL-SPC12500	12500



Profile SPZ3

* Effective length in mm.

PROFILE 3V/9J

*LENGTH INDICATION	REFERENCE NUMBER	**OUTSIDE LENGTH
3V335	TL-9J850	850
3V355	TL-9J900	900
3V375	TL-9J950	950
3V400	TL-9J1015	1015
3V425	TL-9J1080	1080
3V450	TL-9J1145	1145
3V475	TL-9J1205	1205
3V500	TL-9J1270	1270
3V530	TL-9J1345	1345
3V560	TL-9J1420	1420
3V600	TL-9J1525	1525
3V630	TL-9J1600	1600
3V670	TL-9J1700	1700
3V710	TL-9J1800	1800
3V750	TL-9J1900	1900
3V800	TL-9J2030	2030
3V850	TL-9J2160	2160
3V900	TL-9J2290	2290
3V950	TL-9J2410	2410
3V1000	TL-9J2540	2540
3V1060	TL-9J2690	2690
3V1120	TL-9J2840	2840
3V1180	TL-9J3000	3000
3V1250	TL-9J3180	3180
3V1320	TL-9J3350	3350
3V1400	TL-9J3550	3550

PROFILE 5V/15J

*LENGTH INDICATION	REFERENCE NUMBER	**OUTSIDE LENGTH
5V500	TL-15J1270	1270
5V530	TL-15J1345	1345
5V560	TL-15J1420	1420
5V600	TL-15J1525	1525
5V630	TL-15J1600	1600
5V670	TL-15J1700	1700
5V710	TL-15J1800	1800
5V750	TL-15J1900	1900
5V800	TL-15J2030	2030
5V850	TL-15J2160	2160
5V900	TL-15J2290	2290
5V950	TL-15J2410	2410
5V1000	TL-15J2540	2540
5V1120	TL-15J2840	2840
5V1180	TL-15J3000	3000
5V1250	TL-15J3180	3180
5V1320	TL-15J3350	3350
5V1400	TL-15J3550	3550
5V1500	TL-15J3810	3810
5V1600	TL-15J4060	4060
5V1700	TL-15J4320	4320
5V1800	TL-15J4570	4570
5V1900	TL-15J4830	4830
5V2000	TL-15J5080	5080
5V2120	TL-15J5380	5380
5V2240	TL-15J5690	5690
5V2360	TL-15J6000	6000
5V2500	TL-15J6350	6350
5V2650	TL-15J6730	6730
5V2800	TL-15J7100	7100
5V3000	TL-15J7620	7620
5V3150	TL-15J8000	8000
5V3350	TL-15J8500	8500
5V3550	TL-15J9000	9000

PROFILE 8V/25J

*LENGTH INDICATION	REFERENCE NUMBER	**OUTSIDE LENGTH
8V1000	TL-25J2540	2540
8V1060	TL-25J2690	2690
8V1120	TL-25J2840	2840
8V1180	TL-25J3000	3000
8V1250	TL-25J3180	3180
8V1320	TL-25J3350	3350
8V1400	TL-25J3550	3550
8V1500	TL-25J3810	3810
8V1600	TL-25J4060	4060
8V1700	TL-25J4320	4320
8V1800	TL-25J4570	4570
8V1900	TL-25J4830	4830
8V2000	TL-25J5080	5080
8V2120	TL-25J5380	5380
8V2240	TL-25J5690	5690
8V2360	TL-25J6000	6000
8V2500	TL-25J6350	6350
8V2650	TL-25J6730	6730
8V2800	TL-25J7100	7100
8V3000	TL-25J7620	7620
8V3150	TL-25J8000	8000
8V3350	TL-25J8500	8500
8V3550	TL-25J9000	9000
8V3750	TL-25J9500	9500
8V4000	TL-25J10160	10160
8V4250	TL-25J10800	10800
8V4500	TL-25J11430	11430
8V4750	TL-25J12060	12060
8V5000	TL-25J12700	12700
8V5600	TL-25J14200	14200
8V6000	TL-25J15250	15250



V-Power band

* Outside length in inches by ten.
 ** All measures in mm.

PROFILE 3VX/9JX

*LENGTH INDICATION	REFERENCE NUMBER	**OUTSIDE LENGTH
3VX250	TL-9J630	630
3VX265	TL-9J670	670
3VX280	TL-9J710	710
3VX300	TL-9J760	760
3VX315	TL-9J800	800
3VX335	TL-9J850	850
3VX355	TL-9J900	900
3VX375	TL-9J950	950
3VX400	TL-9J1015	1015
3VX425	TL-9J1080	1080
3VX450	TL-9J1145	1145
3VX475	TL-9J1205	1205
3VX500	TL-9J1270	1270
3VX530	TL-9J1345	1345
3VX560	TL-9J1420	1420
3VX600	TL-9J1525	1525
3VX630	TL-9J1600	1600
3VX670	TL-9J1700	1700
3VX710	TL-9J1800	1800
3VX750	TL-9J1900	1900
3VX800	TL-9J2030	2030
3VX850	TL-9J2160	2160
3VX900	TL-9J2290	2290
3VX950	TL-9J2410	2410
3VX1000	TL-9J2540	2540
3VX1060	TL-9J2690	2690
3VX1120	TL-9J2840	2840
3VX1180	TL-9J3000	3000
3VX1250	TL-9J3180	3180
3VX1320	TL-9J3350	3350
3VX1400	TL-9J3550	3550

PROFILE 5VX/15JX

*LENGTH INDICATION	REFERENCE NUMBER	**OUTSIDE LENGTH
5VX500	TL-15J1270	1270
5VX530	TL-15J1345	1345
5VX560	TL-15J1420	1420
5VX600	TL-15J1525	1525
5VX630	TL-15J1600	1600
5VX670	TL-15J1700	1700
5VX710	TL-15J1800	1800
5VX800	TL-15J2030	2030
5VX850	TL-15J2160	2160
5VX900	TL-15J2290	2290
5VX950	TL-15J2410	2410
5VX1000	TL-15J2540	2540
5VX1060	TL-15J2690	2690
5VX1120	TL-15J2840	2840
5VX1180	TL-15J3000	3000
5VX1250	TL-15J3180	3180
5VX1320	TL-15J3350	3350
5VX1400	TL-15J3550	3550
5VX1500	TL-15J3810	3810
5VX1600	TL-15J4060	4060
5VX1700	TL-15J4320	4320
5VX1800	TL-15J4570	4570
5VX1900	TL-15J4830	4830
5VX2000	TL-15J5080	5080

FLAT BELTS

This type of belts combine high flexibility and traction, permitting drives with smaller pulley diameters. They can work at high speeds without been affected by the drive-reducing centrifugal force effect.

	TYPE		
	TL-EFB1	TL-EFB2	TL-EFB3
Thickness. mm	1,90	2,20	4,20
Aprox weight in g/m per cm of width	24	27	40
Width. mm	15 - 600	15 - 600	15 - 300*
Minimum pulley diameter. mm	25	50	100

* Consult to our Commercial Department.

Nomenclature: An alphanumeric string with blocs defining the type, the length in mm and the width in mm. The flat belt TL-EFB2-850-100 stands for a flat belt, 2,20 mm thick, 850 mm long and 100 mm wide.

Of rugged construction with faces reinforced by textiles which provide a high friction coefficient and elasticity. In endless format and lengths up to ten meters. Available in every width up to 600 mm.



* Outside length in tenths of inches.

** All measures in mm.

BANDED V-BELTS FOR AGRICULTURE

We have a comprehensive program of replacement V-Belts for Combine Harvester for major International brands.

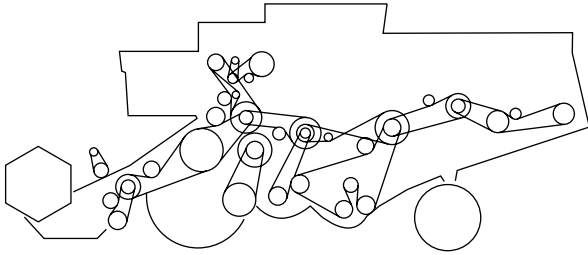

Consult our commercial department for information.



TIPS ON V-BELTS

The tips hereunder help to prevent a premature wear of V-Belts in a recollection of good practices.

Alignment of pulleys

Misalignment occurs when the driving and driven shafts are not parallel, that is angular misalignment, when the driving and driven shafts are crossed, that is twisting misalignment and when the driving and driven pulley's faces are offset, that is offset misalignment. These misalignments may be present individually or combined. Misalignment is one of the causes of premature wear by over.

Alignment

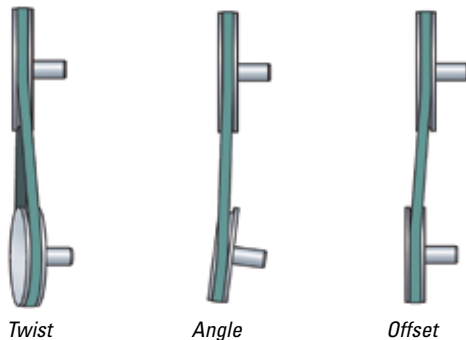

Run-Out

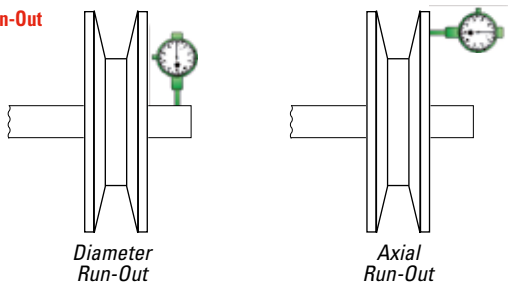

Belt tensioning

Improper belt tensioning is a major cause for belt premature failure. An under-tensioned belt provokes slippage, rollover, overheating and noise with the result of poor power transmission and higher maintenance costs.

The other way round, over tensioned belts provoke a premature wear of bearings, shafts and pulleys. The ideal belt tension is the lowest at which the belt does not slip or jump under the driving peak conditions, in other words, the question is to have the lowest tension to carry the load without slip. A tension gauge to check the proper tension may be used. See page K20 for the procedure.

Diameter of the pulleys

The diameter of the pulleys have a high incidence on the belt life. The use of smaller pulleys than those recommended will increase the belt tension and reduce the overall belt life. See pages D3, D10 and D14 for the minimum pulley outside diameters for the different families of V-Belts.

Matching & Mixing

In the case of multiple-groove driving, the V-Belts have to be of the same length, otherwise, the shortest belt carries the load. Equivalent V-Belts from different makers have different lengths, consequently, to install V-Belt of different makes is not advisable.

Mixing new with used belts is not adequate. Whenever V-Belts have to be replaced, the whole set should be changed.

Other aspects to take into consideration:

Foreign matter: Its presence compromises the smooth driving as well as causing the breakage of the belts, the rollover or premature wear of both, belts and pulleys

Squeal & Squeak: A squealing noise indicates that belt slips, especially during motor acceleration or when operates at full load. The remedy is by adjusting the belt tension.

A squeaking noise as annoying as it may sound, does not affect to the belt's life. Normally indicates either, a misalignment or excessive wet or dry.

Roll over: It may indicate a severe misalignment, worn pulleys or heavy pulsating loads.

Oil & Grease: Accelerate the wear and failure of the belts by creating slippage and chemically attacking the belts.



Safety

As already stated at the beginning of this catalog, see page 25, the power transmission products are potentially dangerous. Thus following the recommendations is necessary. The first thing is making sure to choose the right belt for the specific application, stop the drive while doing maintenance and always use well covered protective guards.

V-RIBBED BELTS

The Standard ISO 1081 establishes the definitions of V-Belts as V-Ribbed belts and corresponding grooved pulleys. The Standard ISO 9982 is about the Pulleys and V-Ribbed belts for industrial applications – PH, PJ, PK, PL and PM profiles and dimensions.

A V-ribbed belt is defined as a belt with a longitudinally ribbed traction surface which engages and grips, by friction, pulley grooves of similar shape.

Pitch line: A circumference in the belt which keeps the same length when the belt is bent perpendicular to its back.

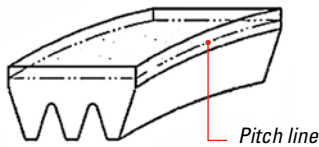

Effective length: The length of a virtual line circumscribing a V-Ribbed belt at the level of the effective diameter of the measuring pulleys whilst the V-ribbed belt is at a specified tension.

The method to measure the effective length of a V-Ribbed belt is by the use of two pulleys of the same effective diameter. The effective length is the result obtained by the addition the circumference of one pulley to twice the measured distance between the pulley centers.

Free length: Length of the belt under a tension equal at 10% of measuring tension.

Drive length: Length of the belt, with regard to the nominal positions and effective diameters of pulleys and idlers.

Elongation: Variation of the length of the belt between the free length and the drive length.

Rib pitch: Distance between the center lines of two adjacent ribs. Denoted P_b in the figure ahead

Nominal belt width: Transverse dimension of the belt. Defined as well as a multiple of the rib pitch and the number of ribs. Denoted b in the figure ahead.

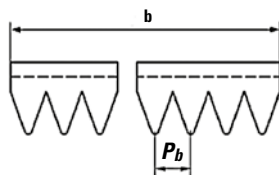

V-ribbed pulley: Pulley with several equidistant grooves, obtained by rotation of a symmetrical V-Shaped profile around the pulley axis at a constant pitch diameter.

Flat pulley: Cylindrical pulley applied either to the back or the ribbed surface of the belt.

Pulley groove: One of the several V-Shaped profiles formed in the pulley rim to engage with the belt ribs.

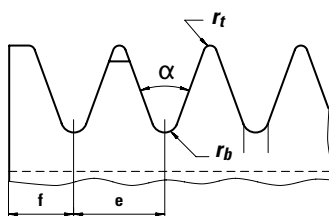

Groove pitch: Distance between the center lines of two adjacent grooves, e in the figure

Transitional radius. Radius at the tip of adjacent grooves, connecting the groove flanks, r_t in the figure.

Groove bottom radius. Radius, at the bottom of a groove, connecting the Groove flanks, r_b in the figure.

Angle of pulley Groove. Angle between two consecutive flanks of the pulley groove, α in the figure.

Pitch diameter. Diameter of the pulley at the pitch line level of the belt used with this pulley, d_p in the figure

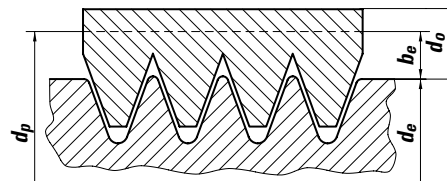

Pitch circumference: Circumference of a circle with a diameter equal to the pitch diameter.

Effective diameter: Reference diameter of the pulley at the tip of the grooves, d_e in the figure

Effective circumference: Circumference of a circle with a diameter equal to the effective diameter.

Effective line differential: Radial displacement between the levels of the pitch circumference and the effective circumference, b_e in the figure. The differential is a correlation term used to calculate the speed ratio when the effective diameter is not known, b_e in the figure.

V-ribbed belt drive: The drive set composed of a single V-Ribbed belt together with two or more pulleys, at least one of which is grooved.

Speed ratio: Ratio of the angular speeds of the pulleys as calculated from the ratio of the pitch diameters of the pulleys, making no allowance for slip and creep.

Power rating: Power that a particular V-Belt or each rib of a V-Ribbed belt can transmit under an specific geometrical and environmental conditions over a given period of time and assuming that the drive is installed and maintained under the accepted rules of the technique.

*PROFILES	PH	PJ	PK	PL	PM
Rib pitch e	1,60	2,34	3,56	4,70	9,40
Belt thickness	2,60	3,50	4,60	6,50	12,80
Minimum pulley diameter d	13	20	45	75	180
Effective line difference	0,80	1,25	1,60	3,50	5,00
Belt speed m/s	60	60	50	40	30
α°	40	40	40	40	40

* All measures in mm.

Ribbed belts, also referred as V-Ribbed belts and Poly-V-Belts, combine the usefulness of a thin belt with a high gripping traction, higher than that of a banded V-Belt which for certain applications makes it a better choice.

The typical applications of the ribbed belts are in compact designs with short center distances and high speed ratio drives.

The thin section of the ribbed belts make possible its use with smaller pulleys than those of the standard V-Belts what means a reduction in weight thus the drive gets more to the load, increasing the efficiency. Ribbed belts can handle speed ratios up 40:1. The high speed remains longer time consistent, given its resistance to seat into the grooves.

As far as power transmission is concerned, the ribbed belts have bigger power transmission capacity per unit of width. Also there is no space between the grooves and consequently there is greater contact area which provides higher and more traction.



*PROFILES	PH	PJ	PK	PL	PM
Rib pitch e	1,60	2,34	3,56	4,70	9,40
Belt thickness h	2,60	3,50	4,60	7,00	12,80
Minimum pulley diameter d_b	13	20	45	75	180
Effective line difference h_b	0,80	1,25	1,60	3,50	5,00
Belt speed m/s	60	60	50	40	30
α°	40	40	40	40	40

* All measures in mm.

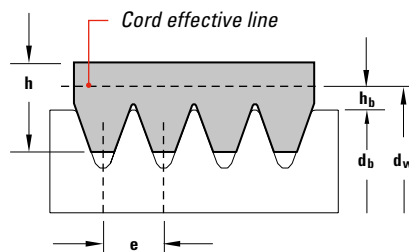

- d_b = Diameter of the pulley at the tip of grooves.
- d_w = Pitch diameter. Position of tension cords. Base of the transmission ratio and speed calculation. $d_w = d_b + 2 h_b$
- h = Belt thickness
- h_b = Effective line difference
- e = Rib pitch

Ribbed V-Belts European Metric DIN 7867 / ISO 9982 and American Inch RMA / MPTA IP 26

Describing Belt drives – Pulleys and V-Ribbed Belts for industrial applications PH, PJ, PK, PL, and PM in metric profiles dimensions.

Designated as H, J, K, L, M in inches.

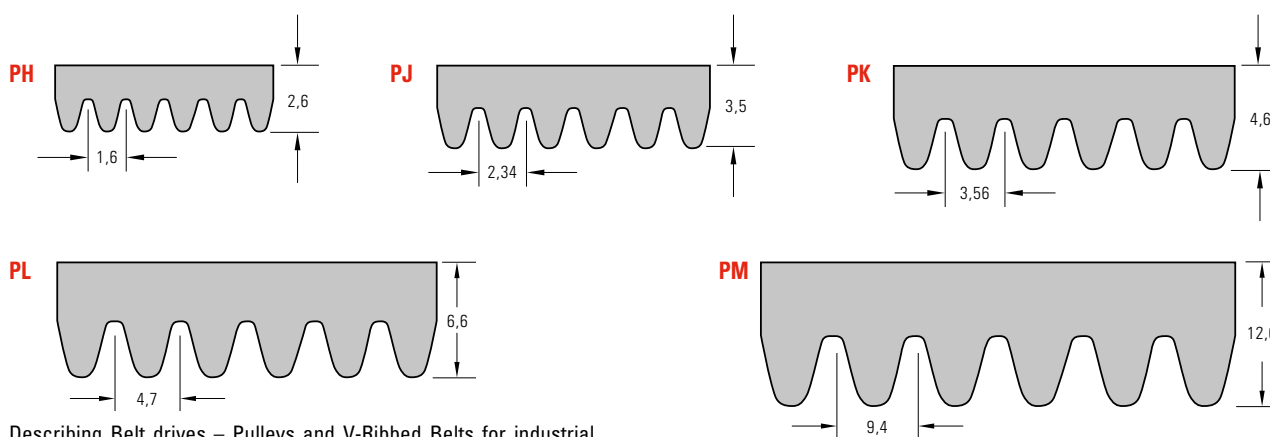

Describing Belt drives – Pulleys and V-Ribbed Belts for industrial applications PH, PJ, PK, PL, and PM in metric profiles dimensions.

Designation example:

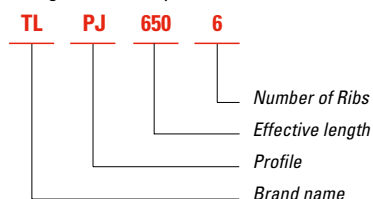

Effective length (See table Page D30):
 • Version PJ: 650 mm
 • Version J: 25,6 inch



PROFILE PH

REFERENCE NUMBER	*EFFECTIVE LENGTH	**EFFECTIVE LENGTH
TL-PH-584-	584	23,0
TL-PH-947-	947	37,3
TL-PH-1011-	1011	39,8
TL-PH-1025-	1025	40,4
TL-PH-1030-	1030	40,6
TL-PH-1068-	1068	42,0
TL-PH-1140-	1140	44,9
TL-PH-1164-	1164	45,8
TL-PH-1184-	1184	46,6
TL-PH-1200-	1200	47,2
TL-PH-1210-	1210	47,6
TL-PH-1265-	1265	49,8
TL-PH-1270-	1270	50,0
TL-PH-1285-	1285	50,6
TL-PH-1290-	1290	50,8
TL-PH-1269-	1269	50,0
TL-PH-1270-	1270	50,0
TL-PH-1285-	1285	50,6
TL-PH-1290-	1290	50,8
TL-PH-1287-	1287	50,7
TL-PH-1288-	1288	50,7
TL-PH-1289-	1289	50,7
TL-PH-1290-	1290	50,8
TL-PH-1301-	1301	51,2
TL-PH-1371-	1371	54,0
TL-PH-1293-	1293	50,9
TL-PH-1397-	1397	55,0
TL-PH-1475-	1475	58,1
TL-PH-1600-	1600	63,0
TL-PH-1809-	1809	71,2
TL-PH-1831-	1831	72,1
TL-PH-1856-	1856	73,1
TL-PH-1872-	1872	73,7
TL-PH-1891-	1891	74,4
TL-PH-1900-	1900	74,8
TL-PH-1915-	1915	75,4
TL-PH-1922-	1922	75,7
TL-PH-1930-	1930	76,0
TL-PH-1945-	1945	76,6
TL-PH-1980-	1980	78,0

PROFILE PJ

REFERENCE NUMBER	*EFFECTIVE LENGTH	**EFFECTIVE LENGTH
TL-PJ-350-	350	13,8
TL-PJ-381-	381	15,0
TL-PJ-406-	406	16,0
TL-PJ-432-	432	17,0
TL-PJ-457-	457	18,0
TL-PJ-483-	483	19,0
TL-PJ-495-	495	19,5
TL-PJ-508-	508	20,0
TL-PJ-533-	533	21,0
TL-PJ-559-	559	22,0
TL-PJ-584-	584	23,0
TL-PJ-610-	610	24,0
TL-PJ-635-	635	25,0
TL-PJ-650-	650	25,6
TL-PJ-660-	660	26,0
TL-PJ-685-	685	27,0
TL-PJ-711-	711	28,0
TL-PJ-723-	723	28,5
TL-PJ-737-	737	29,0
TL-PJ-762-	762	30,0
TL-PJ-769-	769	30,3
TL-PJ-790-	790	31,1
TL-PJ-813-	813	32,0
TL-PJ-864-	864	34,0
TL-PJ-895-	895	35,2
TL-PJ-914-	914	36,0
TL-PJ-944-	944	37,2
TL-PJ-955-	955	37,6
TL-PJ-965-	965	38,0
TL-PJ-990-	990	39,0
TL-PJ-1016-	1016	40,0
TL-PJ-1036-	1036	40,8
TL-PJ-1040-	1040	40,9
TL-PJ-1051-	1051	41,4
TL-PJ-1065-	1065	41,9
TL-PJ-1080-	1080	42,5
TL-PJ-1089-	1089	42,9
TL-PJ-1092-	1092	43,0
TL-PJ-1100-	1100	43,3
TL-PJ-1108-	1108	43,6
TL-PJ-1116-	1116	43,9
TL-PJ-1136-	1136	44,7
TL-PJ-1143-	1143	45,0
TL-PJ-1150-	1150	45,3
TL-PJ-1160-	1160	45,7

REFERENCE NUMBER	*EFFECTIVE LENGTH	**EFFECTIVE LENGTH
TL-PJ-1168-	1168	46,0
TL-PJ-1170-	1170	46,1
TL-PJ-1184-	1184	46,6
TL-PJ-1190-	1190	46,9
TL-PJ-1194-	1194	47,0
TL-PJ-1200-	1200	47,2
TL-PJ-1203-	1203	47,4
TL-PJ-1210-	1210	47,6
TL-PJ-1214-	1214	47,8
TL-PJ-1222-	1222	48,1
TL-PJ-1232-	1232	48,5
TL-PJ-1236-	1236	48,7
TL-PJ-1244-	1244	49,0
TL-PJ-1262-	1262	49,7
TL-PJ-1270-	1270	50,0
TL-PJ-1280-	1280	50,4
TL-PJ-1287-	1287	50,7
TL-PJ-1295-	1295	51,0
TL-PJ-1301-	1301	51,2
TL-PJ-1302-	1302	51,3
TL-PJ-1315-	1315	51,8
TL-PJ-1318-	1318	51,9
TL-PJ-1321-	1321	52,0
TL-PJ-1326-	1326	52,2
TL-PJ-1365-	1365	53,7
TL-PJ-1371-	1371	54,0
TL-PJ-1397-	1397	55,0
TL-PJ-1428-	1428	56,2
TL-PJ-1473-	1473	58,0
TL-PJ-1524-	1524	60,0
TL-PJ-1549-	1549	61,0
TL-PJ-1600-	1600	63,0
TL-PJ-1651-	1651	65,0
TL-PJ-1752-	1752	69,0
TL-PJ-1854-	1854	73,0
TL-PJ-1895-	1895	74,6
TL-PJ-1910-	1910	75,2
TL-PJ-1930-	1930	76,0
TL-PJ-1956-	1956	77,0
TL-PJ-2063-	2063	81,2
TL-PJ-2135-	2135	84,1
TL-PJ-2210-	2210	87,0
TL-PJ-2337-	2337	92,0
TL-PJ-2498-	2498	98,3

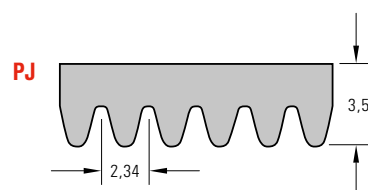
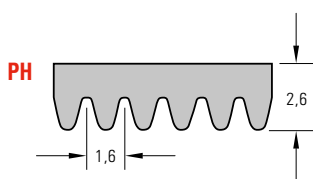

* All measures in mm.
 ** All measures in inches.

PROFILE PK

REFERENCE NUMBER	*EFFECTIVE LENGTH	**EFFECTIVE LENGTH
TL-PK-588-	588	23,1
TL-PK-630-	630	24,8
TL-PK-650-	650	25,6
TL-PK-675-	675	26,6
TL-PK-700-	700	27,6
TL-PK-730-	730	28,7
TL-PK-755-	755	29,7
TL-PK-775-	775	30,5
TL-PK-800-	800	31,5
TL-PK-830-	830	32,7
TL-PK-845-	845	33,3
TL-PK-870-	870	34,3
TL-PK-875-	875	34,4
TL-PK-885-	885	34,8
TL-PK-920-	920	36,2
TL-PK-925-	925	36,4
TL-PK-950-	950	37,4
TL-PK-970-	970	38,2
TL-PK-1000-	1000	39,4
TL-PK-1015-	1015	40,0
TL-PK-1035-	1035	40,7
TL-PK-1060-	1060	41,7
TL-PK-1080-	1080	42,5
TL-PK-1145-	1145	45,1
TL-PK-1165-	1165	45,9
TL-PK-1200-	1200	47,2
TL-PK-1230-	1230	48,4
TL-PK-1300-	1300	51,2
TL-PK-1335-	1335	52,6
TL-PK-1385-	1385	54,5
TL-PK-1420-	1420	55,9
TL-PK-1460-	1460	57,5
TL-PK-1490-	1490	58,7
TL-PK-1520-	1520	59,8
TL-PK-1555-	1555	61,2
TL-PK-1610-	1610	63,4
TL-PK-1655-	1655	65,2
TL-PK-1700-	1700	66,9
TL-PK-1725-	1725	67,9
TL-PK-1755-	1755	69,1
TL-PK-1800-	1800	70,9
TL-PK-1860-	1860	73,2
TL-PK-1885-	1885	74,2
TL-PK-1900-	1900	74,8
TL-PK-1980-	1980	78,0
TL-PK-2050-	2050	80,7
TL-PK-2080-	2080	81,9
TL-PK-2145-	2145	84,4
TL-PK-2235-	2235	88,0
TL-PK-2330-	2330	91,7
TL-PK-2490-	2490	98,0
TL-PK-2555-	2555	100,6

PROFILE PL

REFERENCE NUMBER	*EFFECTIVE LENGTH	**EFFECTIVE LENGTH
TL-PL-953-	953	37,5
TL-PL-991-	991	39,0
TL-PL-1074-	1074	42,3
TL-PL-1080-	1080	42,5
TL-PL-1100-	1100	43,3
TL-PL-1194-	1194	47,0
TL-PL-1270-	1270	50,0
TL-PL-1321-	1321	52,0
TL-PL-1333-	1333	52,5
TL-PL-1371-	1371	54,0
TL-PL-1397-	1397	55,0
TL-PL-1422-	1422	56,0
TL-PL-1435-	1435	56,5
TL-PL-1473-	1473	58,0
TL-PL-1511-	1511	59,5
TL-PL-1562-	1562	61,5
TL-PL-1613-	1613	63,5
TL-PL-1664-	1664	65,5
TL-PL-1715-	1715	67,5
TL-PL-1764-	1764	69,4
TL-PL-1803-	1803	71,0
TL-PL-1841-	1841	72,5
TL-PL-1943-	1943	76,5
TL-PL-1956-	1956	77,0
TL-PL-1981-	1981	78,0
TL-PL-2020-	2020	79,5
TL-PL-2070-	2070	81,5
TL-PL-2096-	2096	82,5

REFERENCE NUMBER	*EFFECTIVE LENGTH	**EFFECTIVE LENGTH
TL-PL-2134-	2134	84,0
TL-PL-2197-	2197	86,5
TL-PL-2235-	2235	88,0
TL-PL-2324-	2324	91,5
TL-PL-2362-	2362	93,0
TL-PL-2476-	2476	97,5
TL-PL-2515-	2515	99,0
TL-PL-2705-	2705	106,5
TL-PL-2743-	2743	108,0
TL-PL-2845-	2845	112,0
TL-PL-2895-	2895	114,0
TL-PL-2921-	2921	115,0
TL-PL-2997-	2997	118,0
TL-PL-3086-	3086	121,5
TL-PL-3124-	3124	123,0
TL-PL-3289-	3289	129,5
TL-PL-3327-	3327	131,0
TL-PL-3492-	3492	137,5
TL-PL-3683-	3683	145,0
TL-PL-3696-	3696	145,5
TL-PL-4051-	4051	159,5
TL-PL-4191-	4191	165,0
TL-PL-4470-	4470	176,0
TL-PL-4622-	4622	182,0
TL-PL-5029-	5029	198,0
TL-PL-5385-	5385	212,0
TL-PL-6069-	6069	240,0

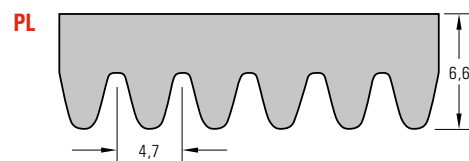
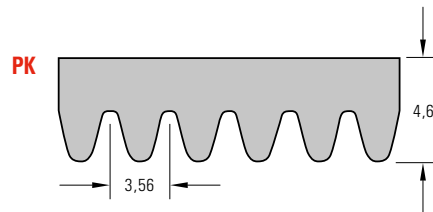

* All measures in mm.
 ** All measures in inches.

PROFILE PM

REFERENCE NUMBER	*EFFECTIVE LENGTH	**EFFECTIVE LENGTH
TL-PM-2286-	2286	90,0
TL-PM-2388-	2388	94,0
TL-PM-2515-	2515	99,0
TL-PM-2693-	2693	106,0
TL-PM-2832-	2832	111,5
TL-PM-2921-	2921	115,0
TL-PM-3010-	3010	118,5
TL-PM-3124-	3124	123,0
TL-PM-3327-	3327	131,0
TL-PM-3531-	3531	139,0

REFERENCE NUMBER	*EFFECTIVE LENGTH	**EFFECTIVE LENGTH
TL-PM-3734-	3734	147,0
TL-PM-4089-	4089	161,0
TL-PM-4191-	4191	165,0
TL-PM-4470-	4470	176,0
TL-PM-4648-	4648	183,0
TL-PM-5029-	5029	198,0
TL-PM-5410-	5410	213,0
TL-PM-6121-	6121	241,0
TL-PM-6883-	6883	271,0
TL-PM-7646-	7646	301,0

REFERENCE NUMBER	*EFFECTIVE LENGTH	**EFFECTIVE LENGTH
TL-PM-8408-	8408	331,0
TL-PM-9169-	9169	361,0
TL-PM-9931-	9931	391,0
TL-PM-10693-	10693	421,0
TL-PM-12217-	12217	481,0
TL-PM-13741-	13741	541,0
TL-PM-15266-	15266	601,0
TL-PM-16764-	16764	660,0

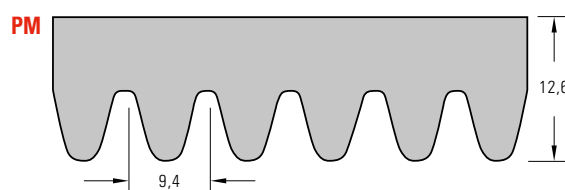

* All measures in mm.
 ** All measures in inches.

FHP V-BELTS

Fractional Horsepower V-Belts are manufactured for light duty fractional horsepower motors (1HP or less).

They follow the same design profile than the Classical Series A through E. They are used in light applications. The designation of this series corresponds to the top width expressed in 8 th's of an inch, i.e., 2L top width is 1/4". The series start with 2L and follows 3L, 4L and 5L.

This series are commonly used in heating, ventilation, air conditioning and Refrigeration HVACR, lawn mowers, light agricultural machinery and other light applications. They are manufactured to be

heat, oil and ozone resistant. They are available in Raw-edge side walls and in Wrapped version.

The nomenclature is structured by a first string of alfa numbers corresponding to the model and a second numerical string corresponding to the outside length in inches multiplied by ten, hence.

The TL-4LX-470 is an FHP V-Belt, Series 4L, 4 stands the top width in eighths of an inch, 1/2 inch, L stands for Light, X stands for Side wall Raw-edge, 470 is the lengths expressed in tenths of an inch, 47 inches at the outside circumference.

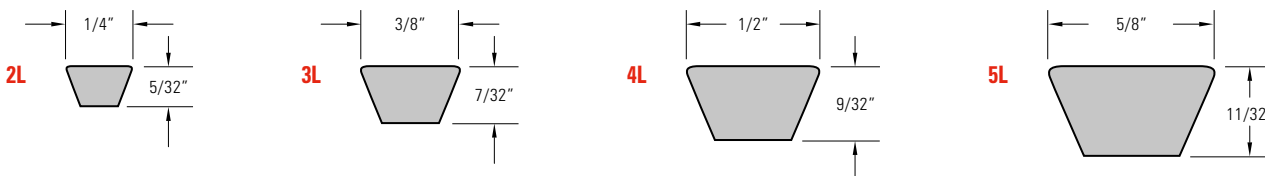

Profiles

2L 1/4 x 5/32 **3L** 3/8 x 7/36 **4L** 1/2 x 9/32 **5L** 5/8 x 11/32

FHP 2L a 5L

PROFILES	2L	3L	4L	5L
Belt high in h	5/32	7/32	9/32	11/32
Belt top width in b	1/4	3/8	1/2	5/8
Angle α°	40	40	40	40



PROFILE 2L

*REFERENCE NUMBER	**OUTSIDE LENGTH
TL-2L-120	12
TL-2L-140	14
TL-2L-150	15
TL-2L-160	16
TL-2L-180	18
TL-2L-190	19
TL-2L-200	20
TL-2L-220	22
TL-2L-240	24
TL-2L-260	26
TL-2L-300	30
TL-2L-310	31
TL-2L-320	32

PROFILE 3L

*REFERENCE NUMBER	**OUTSIDE LENGTH
TL-3L-120	12
TL-3L-130	13
TL-3L-140	14
TL-3L-150	15
TL-3L-160	16
TL-3L-170	17
TL-3L-180	18
TL-3L-190	19
TL-3L-200	20
TL-3L-210	21
TL-3L-220	22
TL-3L-230	23
TL-3L-240	24
TL-3L-250	25
TL-3L-260	26
TL-3L-270	27
TL-3L-280	28
TL-3L-290	29
TL-3L-300	30

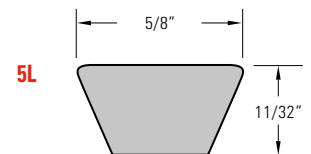
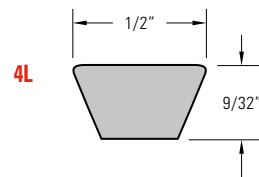
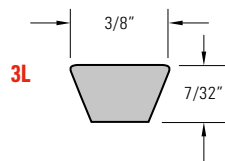
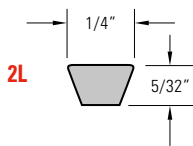

PROFILE 4L

*REFERENCE NUMBER	**OUTSIDE LENGTH
TL-4L-150	15
TL-4L-160	16
TL-4L-170	17
TL-4L-180	18
TL-4L-190	19
TL-4L-200	20
TL-4L-210	21
TL-4L-220	22
TL-4L-230	23
TL-4L-240	24
TL-4L-250	25
TL-4L-260	26
TL-4L-270	27
TL-4L-280	28
TL-4L-290	29
TL-4L-300	30
TL-4L-320	32
TL-4L-330	33
TL-4L-340	34
TL-4L-350	35
TL-4L-360	36
TL-4L-370	37
TL-4L-380	38
TL-4L-390	39
TL-4L-400	40
TL-4L-410	41
TL-4L-420	42
TL-4L-430	43
TL-4L-440	44
TL-4L-450	45
TL-4L-460	46
TL-4L-470	47
TL-4L-480	48
TL-4L-490	49
TL-4L-500	50
TL-4L-510	51
TL-4L-520	52
TL-4L-530	53
TL-4L-540	54
TL-4L-550	55
TL-4L-560	56
TL-4L-570	57
TL-4L-580	58
TL-4L-590	59
TL-4L-600	60

PROFILE 5L

*REFERENCE NUMBER	**OUTSIDE LENGTH
TL-5L-230	23
TL-5L-240	24
TL-5L-250	25
TL-5L-260	26
TL-5L-270	27
TL-5L-280	28
TL-5L-290	29
TL-5L-300	30
TL-5L-310	31
TL-5L-320	32
TL-5L-330	33
TL-5L-340	34
TL-5L-350	35
TL-5L-360	36
TL-5L-370	37
TL-5L-380	38
TL-5L-390	39
TL-5L-400	40
TL-5L-410	41
TL-5L-420	42
TL-5L-430	43
TL-5L-440	44
TL-5L-450	45
TL-5L-460	46
TL-5L-470	47
TL-5L-480	48
TL-5L-490	49
TL-5L-500	50
TL-5L-510	51
TL-5L-520	52
TL-5L-530	53
TL-5L-540	54
TL-5L-550	55
TL-5L-560	56
TL-5L-570	57
TL-5L-580	58
TL-5L-590	59
TL-5L-600	60

* Length in tenths of inches.
 ** All measures in inches.

LINKED BELTS

This type of belts was developed in view to a fast and easy installation and replacement of classical V-Belts in case of break. As its name indicates the belt is made up of several links which are assembled together to any length.

Ideal for use in an emergency and in cases where the drive does not allow a take-up.

They have similar cross section dimensions as the classical V-Belts.

They are made out of polyurethane reinforced by layers of polyester fabric and has two versions, without and with studs. Called as well T-nut type.

They may be used with pulleys A,B,C and AK & BK either with BTS Bore to Size or with Taper Bushings, type TL, QD or ST.

Delivered in rolls of 30 meters.

*STANDARD PROFILE	3L/Z10	4L/A13	5L/B17	C/22
Belt width	10	13	17	22
Aprox weight g/m	43	76,5	117,5	178,5
Min pulley diameter	45	80	140	225
Minimum roll in m	30	30	30	30
Color	Red	Red	Red	Red
Reference	TL-PT3L/Z10	TL-PT4L/A13	TL-PT5L/B17	TL-PTC22

* All measures in mm.

*T-NUT PROFILE	3L/Z	4L/A	5L/B	C/22
Belt width	10	13	17	22
Aprox weight g/m	43	76,5	117,5	178,5
Min pulley diameter	45	80	140	225
Minimum roll in m	30	30	30	30
Color	Orange	Orange	Orange	Orange
Reference	TL-TN3L/Z10	TL-TN4L/A13	TL-TN5L/B17	TL-TNC22

* All measures in mm.



ROUND BELTS

Known as well as endless round belts are light to heavy duty transmission belts. They may be solid or hollow. They keep contact with the pulley groove surface by friction and they are stretched to operate.

They are used in small power transmission, in packaging machinery, systems in low traction, conveyors, photocopiers a quarter turn, twisted and serpentine drives.

Our product is constructed of polyurethane in solid and hollow versions, in different diameters and in two series, the 85A and 90A.

The round belt run in pulleys with a round groove, although they may be used in V-groove classical 2L, 3L, A13, B/17, C22.

Nomenclature: Consists of string with the Shore* hardness, the first letter of the color, the reinforcement if any and the diameter of the belt or the size in case of a trapezoidal profile.

*See chapter *ENGINEERING*, page núm. L2 for the basics of Shore hardness.

85A GREEN SOLID ROUND BELT

REFERENCE NUMBER	DIAMETER	SECTION	MINIMUM	WORKING LOAD	LENGTH OF ROLLS
	mm	sqcm	pulley dia mm	daN/Belt	m
TL-85AG-2	2	0,031	15	0,60	200
TL-85AG-3	3	0,071	25	1,30	200
TL-85AG-4	4	0,126	30	2,30	200
TL-85AG-4,8	4,8	0,181	40	3,30	200
TL-85AG-5	5	0,197	45	3,50	100
TL-85AG-6	6	0,283	55	5,10	100
TL-85AG-6,3	6,3	0,312	60	5,60	100
TL-85AG-7	7	0,385	65	6,90	100
TL-85AG-8	8	0,503	75	9,00	100
TL-85AG-9,5	9,5	0,710	90	12,70	100
TL-85AG-10	10	0,787	95	14,00	50
TL-85AG-12	12	1,133	110	20,10	30
TL-85AG-12,5	12,5	1,229	115	22,00	30
TL-85AG-15	15	1,770	140	31,80	30
TL-85AG-18	18	2,548	170	45,50	30
TL-85AG-20	20	3,146	180	56,50	30

Smooth or Rough surface options.



85A ORANGE SOLID ROUND BELT

REFERENCE NUMBER	DIAMETER	SECTION	MINIMUM	WORKING LOAD	LENGTH OF ROLLS
	mm	sqcm	pulley dia mm	daN/Belt	m
TL-85AO-2	2	0,031	15	0,80	200
TL-85AO-3	3	0,071	25	1,80	200
TL-85AO-4	4	0,126	30	3,10	200
TL-85AO-4,8	4,8	0,181	40	4,50	200
TL-85AO-5	5	0,197	45	4,90	100
TL-85AO-6	6	0,283	55	7,00	100
TL-85AO-6,3	6,3	0,312	60	7,70	100
TL-85AO-7	7	0,385	65	9,60	100
TL-85AO-8	8	0,503	75	12,50	100
TL-85AO-9,5	9,5	0,710	90	17,50	100
TL-85AO-10	10	0,787	95	19,60	50
TL-85AO-12	12	1,133	110	28,00	30
TL-85AO-12,5	12,5	1,229	115	30,50	30
TL-85AO-15	15	1,770	140	44,00	30
TL-85AO-18	18	2,548	170	63,00	30
TL-85AO-20	20	3,146	180	78,00	30

Smooth or Rough surface options.



85A GREEN GLASS FIBER CORD ROUND

REFERENCE NUMBER	DIAMETER	SECTION	CORD DIA	MINIMUM	WORKING LOAD	LENGTH OF ROLLS
	mm	sqcm	mm	pulley dia mm	daN/Belt	m
TL-85AG-GF-8	8	0,503	3	80	15,00	100
TL-85AG-GF-9,5	9,5	0,710	3	95	21,30	100
TL-85AG-GF-10	10	0,787	3	100	23,60	50
TL-85AG-GF-12	12	1,133	4	120	33,90	30
TL-85AG-GF-12,5	12,5	1,229	4	125	36,90	30
TL-85AG-GF-15	15	1,770	4	150	53,10	30

Smooth or Rough surface options.



85A GREEN KEVLAR CORD ROUND BELT

REFERENCE NUMBER	DIAMETER	SECTION	CORD DIA	MINIMUM	WORKING LOAD	LENGTH OF ROLLS
	mm	sqcm	mm	pulley dia mm	daN/Belt	m
TL-85AG-K-6	6	0,283	1,5	60	7,90	100
TL-85AG-K-6,3	6,3	0,312	1,5	65	8,70	100
TL-85AG-K-7	7	0,385	1,5	70	10,80	100
TL-85AG-K-8	8	0,503	2,1	80	15,10	100
TL-85AG-K-9,5	9,5	0,710	2,1	95	21,30	100
TL-85AG-K-10	10	0,787	2,1	100	23,60	50
TL-85AG-K-12	12	1,133	2,1	120	33,9	30
TL-85AG-K-15	15	1,770	3	150	56,5	30
TL-85AG-K-18	18	2,548	3	190	81,4	30
TL-85AG-K-20	20	3,146	3	200	100,5	30

Smooth or Rough surface options.



90A RED SOLID V-BELT

REFERENCE NUMBER	DIAMETER	SECTION	CORD DIA	MINIMUM	WORKING LOAD	LENGTH OF ROLLS
	mm	sqcm	mm	pulley dia mm	daN/Belt	m
TL-90AR-8 x 5	8 x 5	0,320	1,5	60	7,90	100
TL-90AR-Z10	10 X 6	0,480	1,5	65	8,70	100
TL-90AR-A13	13 X 8	0,820	1,5	70	10,80	100
TL-90AR-B17	17 X 11	1,460	2,1	80	15,10	100
TL-90AR-C22	22 X 14	2,400	2,1	95	21,30	100

Smooth or Rough surface options.



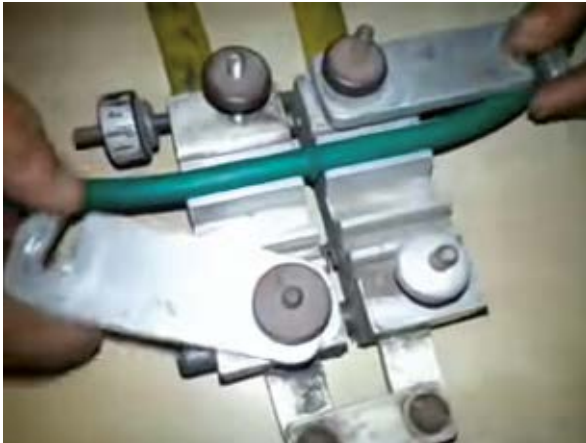

GUIDE TO ORDER

TL -

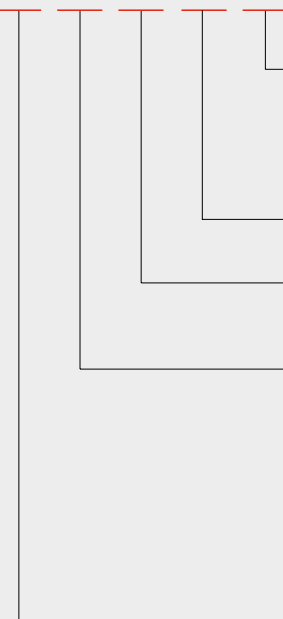

Length
DIN/ISO: Datum length
ARPM/MPTA: Outside length
Variable Speed Belt: Datum length
V-Ribbed Belt: Effective length
FHP V-Belt: Outside length

Profile
 According Standard

Type
W: Wrapped
X: Cogged Raw Edge

- 1: Classical V-Belt DIN/ISO
- 2: Narrow V-Belt DIN/ISO
- 3: Classical V-Belt ARPM/MPTA
- 4: Narrow V-Belt ARPM/MPTA
- 5: Double V-Belt
- 6: Variable Speed V-Belt
- 7: Banded V-Belt + number of Ribs
- 8: V-Ribbed Belt
- 9: FHP V-Belt
- 10: Linked Belt
- 11: Round Belt

Brand name

Construction:

V-Ribbed Belts: Compound of Polybutadiene SBR rubber and polyester cords.

V-Belts Wrapped: Polychloroprene compound and high tensile polyester cords. Double fabric cover dipped in Chloroprene Rubber.

V-Belts Raw Edge: EPDM compound and high strength polyester cords. Back-side of textile fabric.