



Ferrules



BASICS ON FERRULES

Ferrules index

Ferrules are the elements used to assemble the hydraulic fittings on hydraulic hoses for high pressure. They are specially designed for rubber hydraulic and thermoplastic hoses and amply used as well in industrial hoses. Ferrules are assembled on crimping machines for a

permanent connection or by screwing in the case of reusable ferrules. According the way the fittings are assembled on the hose, we distinguish the types of two-piece crimp fittings, that is ferrule and insert or one-piece fitting, this one displayed in the fittings chapter.

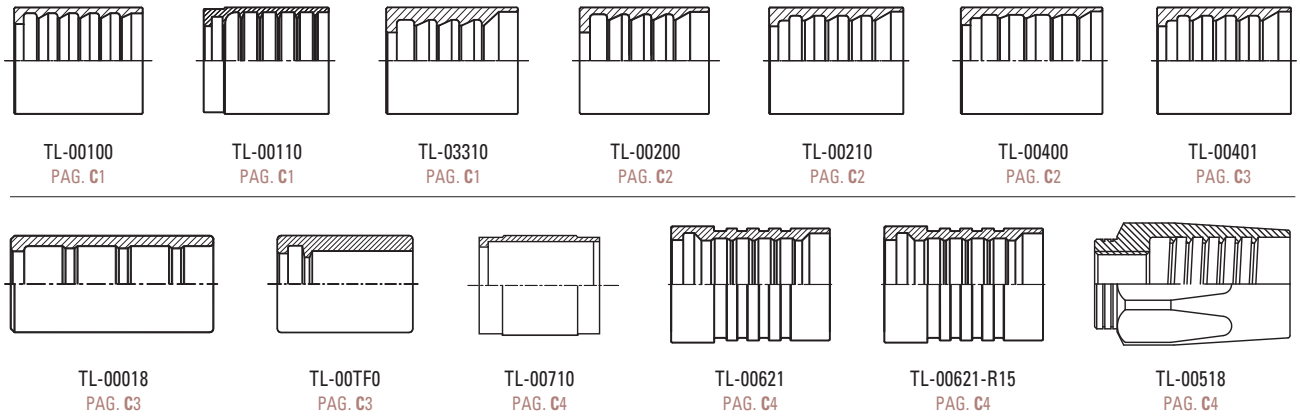

Crimping guide

Non skive

HOSE DN	HOSE DASH	REFERENCE	FERRULE OD	CRIMP GUIDE
6	-4	TL00110-04	19,0	16,8 - 17,2
6	-4	TL00210-04	20,5	18,0 - 18,5
8	-5	TL00110-05	20,5	18,0 - 18,5
8	-5	TL00210-05	22,0	19,0 - 19,5
10	-6	TL00110-06	23,2	20,2 - 20,7
10	-6	TL00210-06	24,5	21,5 - 22,0
13	-8	TL00110-08	27,0	23,5 - 24,0
13	-8	TL00210-08	28,6	25,0 - 25,5
13	-8	TL00400-08	29,0	25,5 - 26,0
16	-10	TL00110-10	30,5	27,0 - 27,5
16	-10	TL00210-10	32,0	28,5 - 29,0
16	-10	TL00400-10	32,5	29,0 - 29,5
19	-12	TL00110-12	34,0	30,0 - 30,5
19	-12	TL00210-12	36,0	31,5 - 32,0
19	-12	TL00400-12	38,0	33,5 - 34,0
25	-16	TL00110-16	42,6	38,0 - 38,5
25	-16	TL00210-16	45,0	40,5 - 41,0
25	-16	TL00400-16	46,0	41,0 - 41,5
32	-20	TL00110-20	50,8	45,5 - 46,3
32	-20	TL00210-20	56,0	50,5 - 51,5
32	-20	TL00400-20	57,0	51,5 - 52,5
32	-20	TL00401-24	53,0	47,5 - 48,5
40	-24	TL00110-24	58,0	53,0 - 54,0
40	-24	TL00210-24	62,5	57,0 - 58,0
40	-24	TL00400-24	65,0	59,0 - 60,0
40	-24	TL00401-24	61,0	55,0 - 56,0
50	-32	TL00110-32	72,0	66,0 - 67,0
50	-32	TL00210-32	75,0	69,0 - 70,0

The crimping dimensions have to be considered as a guideline and can be affected by the tolerance of the hose dimensions.

SWAGGED FITTINGS - FERRULES

TL-00100

SAE 100R1 A. Skive. DIN20022 1ST

PART NO.	HOSE BORE		DIMENSIONS	
	DN	dash	D	L
TL-00100-03	4	03	17.5	27
TL-00100-04	6	04	20.6	30
TL-00100-05	8	05	21.5	31
TL-00100-06	10	06	24	32
TL-00100-08	12	08	28.5	34
TL-00100-10	16	10	32	37
TL-00100-12	20	12	26	43
TL-00100-16	25	16	43	50
TL-00100-20	32	20	50.5	59
TL-00100-24	40	24	57	74
TL-00100-32	50	32	70.6	78

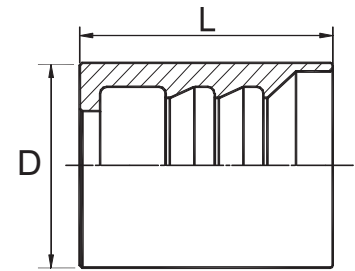

TL-00110

SAE 100R1 AT. Non Skive. EN853 1SN

PART NO.	HOSE BORE		DIMENSIONS	
	DN	dash	D	L
TL-00110-03	5	03	17.5	23
TL-00110-04	6	04	19.80	30
TL-00110-05	8	05	20.80	31
TL-00110-06	10	06	23.30	32
TL-00110-08	12	08	27	34
TL-00110-10	16	10	30	37
TL-00110-12	20	12	34	43
TL-00110-16	25	16	42.60	50
TL-00110-20	32	20	52	59
TL-00110-24	40	24	58	74
TL-00110-32	50	32	72	78

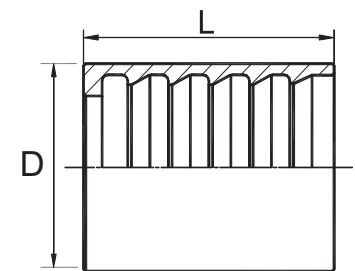

TL-03310

SAE 100R2 AT. Non Skive. EN853 2SN

PART NO.	HOSE BORE		DIMENSIONS	
	DN	dash	D	L
TL-03310-03	5	3	21	23
TL-03310-04	6	4	23	30
TL-03310-05	8	5	24	30
TL-03310-06	10	6	26	32
TL-03310-08	12	8	29	34
TL-03310-10	16	10	33	37
TL-03310-12	20	12	37	42
TL-03310-16	25	16	46,7	51
TL-03310-20	32	20	59	59
TL-03310-24	40	24	67	67
TL-03310-32	50	32	80	72

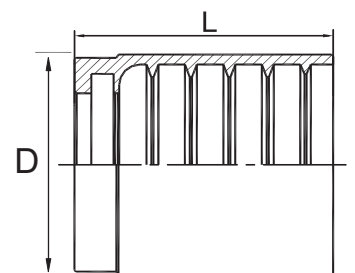

TL-00200

SAE 100R2 AT. Skive. EN853 2SN

PART NO.	HOSE BORE		DIMENSIONS	
	DN	dash	D	L
TL-00200-03	5	03	20.5	23
TL-00200-04	6	04	21	30
TL-00200-05	8	05	24	31
TL-00200-06	10	06	25.5	32
TL-00200-08	12	08	30	34
TL-00200-10	16	10	33.4	37
TL-00200-12	20	12	38	43
TL-00200-16	25	16	46	50
TL-00200-20	32	20	56	59
TL-00200-24	40	24	62	74
TL-00200-32	50	32	75	78

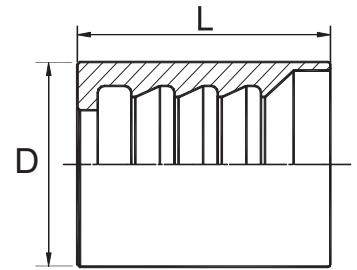

TL-00210

SAE 100R2 AT. Non Skive. DIN20022 2SN

PART NO.	HOSE BORE		DIMENSIONS	
	DN	dash	D	L
TL-00210-03	5	03	20.5	23
TL-00210-04	6	04	22.2	30
TL-00210-05	8	05	23	31
TL-00210-06	10	06	25	32
TL-00210-08	12	08	28.3	34
TL-00210-10	16	10	31.5	37
TL-00210-12	20	12	35.5	43
TL-00210-16	25	16	45	50
TL-00210-20	32	20	55	59
TL-00210-24	40	24	62.5	74
TL-00210-32	50	32	75.5	78

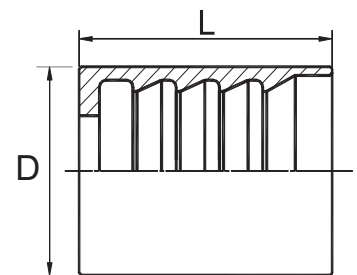

Note: Don't recommend for engineering machine.

TL-00400

4SP, 4SH/12-16, R12/06-16. Skive

PART NO.	HOSE BORE		DIMENSIONS	
	DN	dash	D	L
TL-00400-04	6	04	22	33
TL-00400-06	10	06	25.5	39
TL-00400-08	12	08	29	41
TL-00400-10	16	10	32.5	43
TL-00400-12	20	12	38	51
TL-00400-16	25	16	46	61.5
TL-00400-20	32	20	57	67.5
TL-00400-24	40	24	65	75
TL-00400-32	50	32	79	79

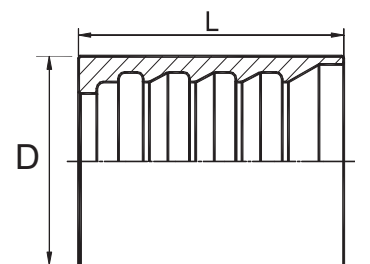

TL-00401

4SH, R12/32. Skive

PART NO.	HOSE BORE		DIMENSIONS	
	DN	dash	D	L
TL-00401-20	32	20	53	67.5
TL-00401-24	40	24	61	75
TL-00401-32	50	32	77	79

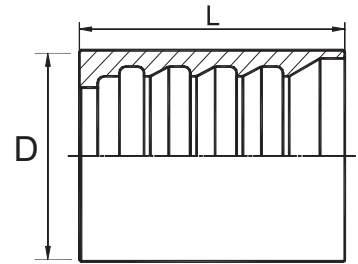

TL-01400

R12/20-24. Skive

PART NO.	HOSE BORE		DIMENSIONS	
	DN	dash	D	L
TL-01400-06	10	06	27.5	39
TL-01400-08	12	08	31.5	41
TL-01400-10	16	10	34	43
TL-01400-12	20	12	39	51
TL-01400-16	25	16	46.5	61.5
TL-01400-20	32	20	55.5	67.5
TL-01400-24	40	24	63.5	75

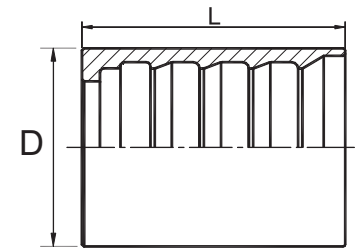

TL-00018

SAE 100R7. Non Skive

PART NO.	HOSE BORE		DIMENSIONS	
	DN	dash	D	L
TL-00018-03	5	3	14,2	27
TL-00018-04	6	4	17	30
TL-00018-05	8	5	19	30
TL-00018-06	10	6	21	30
TL-00018-08	12	8	25,5	34
TL-00018-10	16	10	31,5	36
TL-00018-12	20	12	33	43

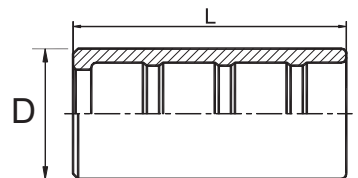

TL-00TF0

Teflon Hose. Non Skive

PART NO.	HOSE BORE		DIMENSIONS	
	DN	dash	D	L
TL-00TF0-02	2	2	11,6	23
TL-00TF0-03	4	3	11,9	27,5
TL-00TF0-04	6	4	14,5	30
TL-00TF0-05	8	5	16	30,6
TL-00TF0-06	10	6	19	32
TL-00TF0-08	12	8	24	35
TL-00TF0-10	16	10	27	37
TL-00TF0-12	20	12	30,1	43
TL-00TF0-14	22	14	33,4	42,7
TL-00TF0-16	25	16	38	50

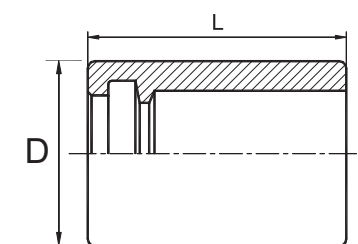

TL-00710

Teflon Hose. Non Skive

PART NO.	HOSE BORE		DIMENSIONS	
	DN	dash	D	L
TL-00710-06	10	06	19.9	28.6
TL-00710-08	12	08	24.4	30
TL-00710-10	16	10	27.5	34
TL-00710-12	20	12	31.6	38
TL-00710-16	25	16	38.4	45.9
TL-00710-20	32	20	49.8	54
TL-00710-24	40	24	55.1	57
TL-00710-32	50	32	68.8	69.8

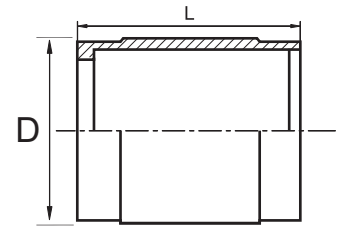

INTERLOCK FITTINGS - FERRULES

TL-00621

R13

PART NO.	HOSE BORE		DIMENSIONS
	DN	dash	
TL-00621-12	20	12	55
TL-00621-16	25	16	68
TL-00621-20	32	20	71
TL-00621-24	40	24	85
TL-00621-32	50	32	108

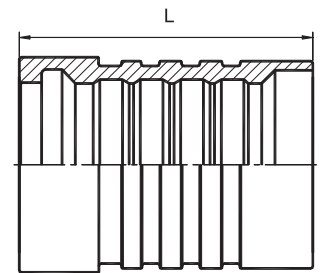

TL-00621-R15

R15

PART NO.	HOSE BORE		DIMENSIONS
	DN	dash	
TL-00621-06(R15)	10	06	40
TL-00621-08(R15)	12	08	42
TL-00621-12(R15)	20	12	53
TL-00621-16(R15)	25	16	66
TL-00621-20(R15)	32	20	88.5
TL-00621-24(R15)	40	24	102

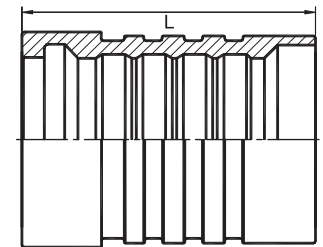

REUSABLE FITTINGS - FERRULES

TL-00518

SAE 100R5

PART NO.	HOSE BORE	DIMENSIONS		
		dash	L	S
TL-00518-04	04		39	19
TL-00518-05	05		39.5	22
TL-00518-06	06		40	24
TL-00518-08	08		45	30
TL-00518-10	10		47	32
TL-00518-12	12		49	36
TL-00518-16	16		58	41
TL-00518-20	20		44.5	46
TL-00518-24	24		47	50
TL-00518-32	32		57	65

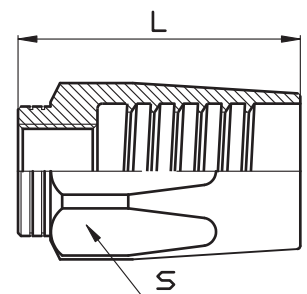



Bearings | **Hydraulics** | Power Transmission

www.translinkpt.com