

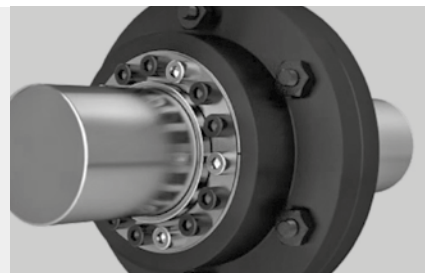

Locking devices

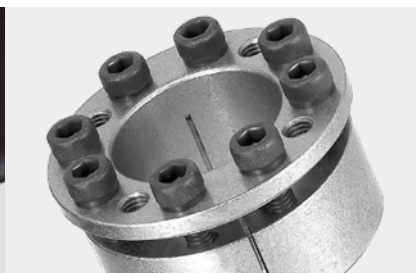

BASICS ON LOCKING DEVICES

Known as well as Friction Assemblies, Keyless Bushings, Friction Devices and others to describe this product, the main characteristic of consisting on the use of friction to perform the 'locking' function between shafts and hubs, shafts and pulleys, gears, sprockets, rollers, cams and others, or making the function of shaft-rigid-couplings by eliminating the pairs key-keyway or splines.

The operation is based on the wedge principle whereas an axial force, applied by tightening a series of screws which engage tapered rings converting the axial force into radial force while the internal tapered ring contracts and the external expands pressing the shaft and the bore surface of the element with the result of generating a high friction force which fix the element in place.

The traditional standard shaft-to-hub mounting is an old technique of the pair key-keyway, the spline shaft and the traditional fit, shrink and press. The Taper Lock type, the QD type, the Split Taper and the XT type are ultimately connected by the pair Key-Keyway, thus having their inherent drawbacks.

Main points of a locking device when comparing with keyed coupling may be summarized:

- Easy assembling and disassembling.
- Eliminates the backlash effect which damage the cotter keys and keyways under torsional or reversal loads.
- Adjustment of shaft and hub is made all along the circumference what makes ideal to be used in precise positioning.
- Eliminates the keyways & cotter keys, splined shafts, grooves, shrink and press fit, or welding to fix shaft with hub. Any of these decrease the strength of the shaft as metal has to be removed, consequently there is a cost saving as well.
- They hold thrust loads as well.
- They may be reused lots of times without losing properties.
- Accepts different types of loads, torque, bending moments as well as radial and axial thrusts.

Locking Devices may be grouped in two types, Internal and Exter-

nal. While the Internal are positioned between the shaft and the hub creating internal and external compression friction force, the External, known as well as Shrink Discs are positioned outside the hub exerting a compression friction force onto the shaft.

Our program is composed of different types and models, covering Internal Devices, External or Shrink Rings and Compression Hubs.

Most of the models of our program are self-centering after the centering effect of the clamping element which produces a minimum error in concentricity and minimizing runout.

There are many applications where the Friction Locking units may be applied, amongst them gears, plates, sprockets, all kinds of hubs, cams, pulleys and other rotating transmission elements, present different configurations and combinations. Used as well as a Rigid Coupling.

The tables ahead display the technical specifications of each Locking Device type. The dimensions of the wedge diameters, the widths, the clearance and the mounting width make up the dimensional specifications represented in the tables by, d the internal wedge diameter, D the external, and letters B and L represent the widths and mounting measures.

The units of performance are grouped in two, the Torque to transmit represented by M_t measured in $N*m$ (Newton * meter) and the axial force or thrust represented by F_t and expressed in N (Newton) conform the first group, while the second group is composed of, the Pressure to the shaft represented by P_w and expressed in $N/sq.mm$ (Newton / square millimeter) and the pressure exerted to the hub represented by P_n as well expressed in $N/sq.mm$.

Finally the tables display information on the bolts exerting the pressure, the quantity, the thread and the mounting torque represented by M_s and expressed in $N*m$.

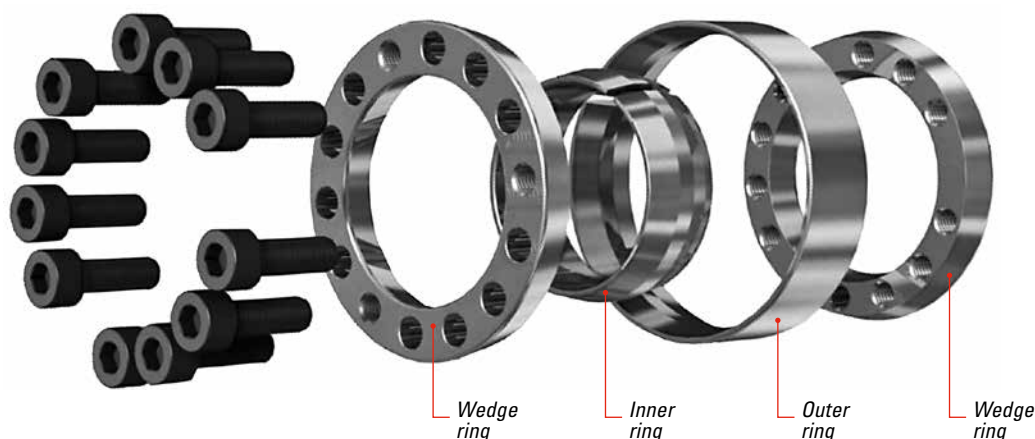

SERIES TL-LOCK1

A cone clamping unit with four pieces, two inside double cone rings joined through a set of tightening screws. Not self-centering. The concentricity of the hub towards the shaft is related to the guide tolerance and its length. Does have any axial movement. It fits to a wide range of shaft diameters from 20 up to a 1000 mm.

Easily assembled and disassembled.

To assemble, once the shaft and hub surfaces are clean, insert the unit into the hub and enter the shaft. Tighten the screws until inner ring contracts grasping the shaft and the outer ring expands and grip the hub bore. Tight the screws following a star-like sequence until reaching to the Ms torque as in the table.

To disassemble, simply loosen the tightening screws. Refer to the general directions in page for assembling and disassembling.

Keys to table headings:

THRUST (F_t) Stands for the axial transmissible force. Expressed in N.

TORQUE (M_t) Stands for the transmissible torque. Expressed in N.m.

PRESSION (P_w) Stands for the perimetral pressure exerted onto the shaft. Expressed in N/mm².

PRESSION (P_n) Stands for the perimetral pressure exerted by the hub surface. Expressed in N/mm².

BOLT TORQUE (M_s) Stands for the suggest bolt's set torque. Expressed in N.m.

REFERENCE	DIMENSIONS			THRUST	TORQUE	PRESSION		CLAMPING BOLTS		
	d x D mm	L1 mm	B mm			Pw	Pn	Qty	Size	Ms
TL-KL1-20 x 47	20 x 47	17	27,50	27000	270	210	90	8	M6	15
TL-KL1-22 x 47	22 x 47	17	27,50	27000	300	195	90	8	M6	15
TL-KL1-24 x 50	24 x 50	17	27,50	30000	360	195	95	8	M6	15
TL-KL1-25 x 50	25 x 50	17	27,50	30000	380	190	95	8	M6	15
TL-KL1-28 x 55	28 x 55	17	27,50	33000	470	185	95	10	M6	15
TL-KL1-30 x 55	30 x 55	17	27,50	33000	500	175	95	10	M6	15
TL-KL1-32 x 60	32 x 60	17	27,50	40000	630	192	105	12	M6	15
TL-KL1-35 x 60	35 x 60	17	27,50	40000	700	180	105	12	M6	15
TL-KL1-38 x 65	38 x 65	17	27,50	46000	870	188	110	14	M6	15
TL-KL1-40 x 65	40 x 65	17	27,50	46000	920	180	110	14	M6	15
TL-KL1-42 x 75	42 x 75	20	33,50	72000	1500	226	125	12	M8	37
TL-KL1-45 x 75	45 x 75	20	33,50	72000	1610	210	125	12	M8	37
TL-KL1-48 x 80	48 x 80	20	33,50	71000	1700	196	115	12	M8	37
TL-KL1-50 x 80	50 x 80	20	33,50	71000	1770	190	115	12	M8	37
TL-KL1-55 x 85	55 x 85	20	33,50	83000	2270	200	130	14	M8	37
TL-KL1-60 x 90	60 x 90	20	33,50	83000	2470	180	120	14	M8	37
TL-KL1-65 x 95	65 x 95	20	33,50	93000	3040	190	130	16	M8	37
TL-KL1-70 x 110	70 x 110	24	39,50	132000	4600	210	130	14	M10	70
TL-KL1-75 x 115	75 x 115	24	39,50	131000	4900	195	125	14	M10	70
TL-KL1-80 x 120	80 x 120	24	39,50	131000	5200	180	120	14	M10	70
TL-KL1-85 x 125	85 x 125	24	39,50	148000	6300	195	130	16	M10	70
TL-KL1-90 x 130	90 x 130	24	39,50	147000	6600	180	125	16	M10	70
TL-KL1-95 x 135	95 x 135	24	39,50	167000	7900	195	135	18	M10	70
TL-KL1-100 x 145	100 x 145	26	47,00	192000	9600	195	135	14	M12	127
TL-KL1-110 x 155	110 x 155	26	47,00	191000	10500	180	125	14	M12	127
TL-KL1-120 x 165	120 x 165	26	47,00	218000	13100	185	135	16	M12	127
TL-KL1-130 x 180	130 x 180	34	52,00	272000	17600	165	115	20	M12	127
TL-KL1-140 x 190	140 x 190	34	52,00	298000	20900	165	125	22	M12	127
TL-KL1-150 x 200	150 x 200	34	52,00	324000	24200	170	125	24	M12	127
TL-KL1-160 x 210	160 x 210	34	52,00	350000	28000	170	130	26	M12	127
TL-KL1-170 x 225	170 x 225	38	60,00	386000	32800	160	120	22	M14	195
TL-KL1-180 x 235	180 x 235	38	60,00	420000	37800	165	125	24	M14	195
TL-KL1-190 x 250	190 x 250	46	68,00	490000	46500	150	115	28	M14	195
TL-KL1-200 x 260	200 x 260	46	68,00	525000	52500	150	115	30	M14	195
TL-KL1-220 x 285	220 x 285	50	74,00	620000	68000	150	115	26	M16	300
TL-KL1-240 x 305	240 x 305	50	74,00	715000	85500	160	125	30	M16	300
TL-KL1-260 x 325	260 x 325	50	74,00	800000	104000	165	130	34	M16	300
TL-KL1-280 x 355	280 x 355	60	86,50	915000	128000	145	115	32	M18	410
TL-KL1-300 x 375	300 x 375	60	86,50	1020000	153000	150	120	36	M18	410
TL-KL1-320 x 405	320 x 405	72	100,50	1310000	210000	150	120	36	M20	590
TL-KL1-340 x 425	340 x 425	72	100,50	1310000	224000	145	115	36	M20	590

NEXT >



REFERENCE	DIMENSIONS			THRUST Fr	TORQUE Mt	PRESSION		CLAMPING BOLTS		
	d x D mm	L1 mm	B mm			Pw	Pn	Qty	Size	Ms
TL-KL1-360 x 455	360 x 455	84	116,00	1630000	294000	145	115	36	M22	790
TL-KL1-380 x 475	380 x 475	84	116,00	1620000	308000	135	110	36	M22	790
TL-KL1-400 x 495	400 x 495	84	116,00	1610000	322000	130	105	36	M22	790
TL-KL1-420 x 515	420 x 515	84	116,00	1780000	370000	135	110	40	M22	790
TL-KL1-440 x 545	440 x 545	96	130,00	2050000	450000	130	105	40	M24	1000
TL-KL1-460 x 565	460 x 565	96	130,00	2030000	465000	125	100	40	M24	1000
TL-KL1-480 x 585	480 x 585	96	130,00	2150000	505000	125	100	42	M24	1000
TL-KL1-500 x 605	500 x 605	96	130,00	2200000	553000	125	100	44	M24	1000
TL-KL1-520 x 630	520 x 630	96	130,00	2300000	592000	125	100	45	M24	1000
TL-KL1-540 x 650	540 x 650	96	130,00	2320000	618000	120	100	45	M24	1000
TL-KL1-560 x 670	560 x 670	96	130,00	2430000	670000	120	100	48	M24	1000
TL-KL1-580 x 690	580 x 690	96	130,00	2520000	727000	120	100	50	M24	1000
TL-KL1-600 x 710	600 x 710	96	130,00	2565000	770000	120	100	50	M24	1000
TL-KL1-620 x 730	620 x 730	96	130,00	2647000	818000	120	100	52	M24	1000
TL-KL1-640 x 750	640 x 750	96	130,00	2698000	860000	115	100	54	M24	1000
TL-KL1-660 x 770	660 x 770	96	130,00	2790000	919000	120	100	56	M24	1000
TL-KL1-680 x 790	680 x 790	96	130,00	2820000	955000	115	100	56	M24	1000
TL-KL1-700 x 810	700 x 810	96	130,00	2945000	1018000	115	100	60	M24	1000
TL-KL1-720 x 830	720 x 830	96	130,00	2965000	1060000	115	100	60	M24	1000
TL-KL1-740 x 850	740 x 850	96	130,00	3065000	1128000	115	100	62	M24	1000
TL-KL1-760 x 870	760 x 870	96	130,00	3170000	1200000	115	100	64	M24	1000
TL-KL1-780 x 890	780 x 890	96	130,00	3205000	1235000	115	100	65	M24	1000
TL-KL1-800 x 910	800 x 910	96	130,00	3260000	1287000	115	100	66	M24	1000
TL-KL1-820 x 930	820 x 930	96	130,00	3330000	1360000	115	100	68	M24	1000
TL-KL1-840 x 950	840 x 950	96	130,00	3445000	1435000	115	100	70	M24	1000
TL-KL1-860 x 950	860 x 950	96	130,00	3525000	1510000	115	100	72	M24	1000
TL-KL1-880 x 990	880 x 990	96	130,00	3610000	1578000	115	100	74	M24	1000
TL-KL1-900 x 1010	900 x 1010	96	130,00	3660000	1635000	115	100	75	M24	1000

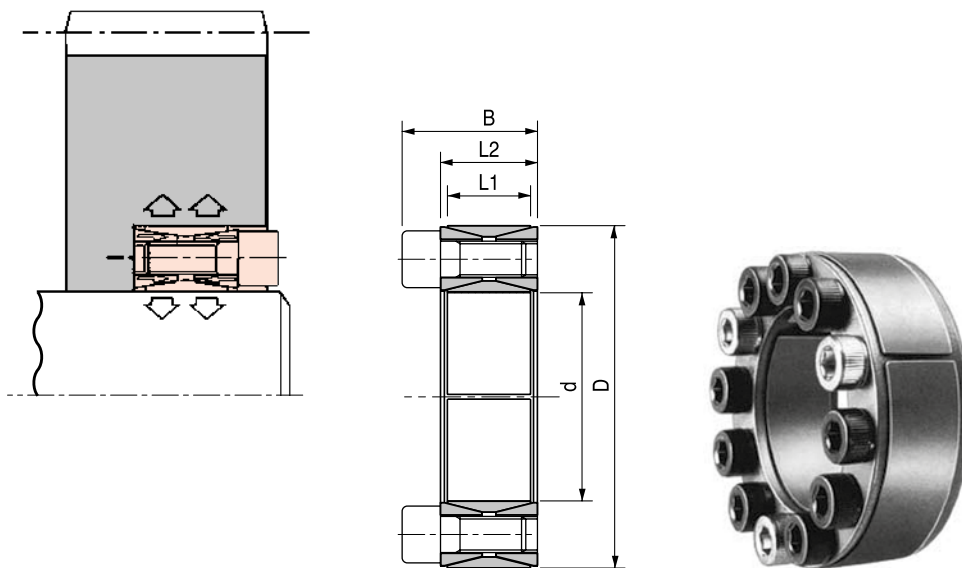

SERIES TL-LOCK2

Two cone rings which must be fastened by a flange. The number of locking screws depends on the torque to be transmitted. Not self centering. Needs a very small axial space for mounting. Up to four units can be mounted in parallel, allowing then high torques to be transmitted.

Available for shaft diameters from 6 up to 600 mm.

Easily assembled and disassembled.

To assemble, once the shaft and hub surfaces are clean, insert the unit into the hub and enter the shaft. Tighten the screws until inner ring contracts grasping the shaft and the outer ring expands and grip the hub bore. Tight the screws following a star-like sequence until reaching to the Ms torque as in the table.

To disassemble, simply loosen the tightening screws. Refer to the general directions in page B23 for assembling and disassembling.

REFERENCE	DIMENSIONS			THRUST Ft	TORQUE Mt	PRESSION	
	d x D mm	L1 mm	B mm			Pw	Pn
TL-KL2-6 x 9	6 x 9	3,70	4,50	840	3	115	75
TL-KL2-7 x 10	7 x 10	3,70	4,50	860	3	115	100
TL-KL2-8 x 11	8 x 11	3,70	4,50	1170	5	115	100
TL-KL2-9 x 12	9 x 12	3,70	4,50	1760	8	115	100
TL-KL2-10 x 13	10 x 13	3,70	4,50	1910	10	135	105
TL-KL2-12 x 15	12 x 15	3,70	4,50	1910	11	115	90
TL-KL2-13 x 16	13 x 16	3,70	4,50	2020	13	110	90
TL-KL2-14 x 18	14 x 18	5,30	6,30	3180	22	115	90
TL-KL2-15 x 19	15 x 19	5,30	6,30	3240	24	110	85
TL-KL2-16 x 20	16 x 20	5,30	6,30	3420	27	105	85
TL-KL2-17 x 21	17 x 21	5,30	6,30	3510	30	105	85
TL-KL2-18 x 22	18 x 22	5,30	6,30	3610	32	100	80
TL-KL2-19 x 24	19 x 24	5,30	6,30	5220	49	140	110
TL-KL2-20 x 25	20 x 25	5,30	6,30	5330	53	135	105
TL-KL2-22 x 26	22 x 26	5,30	6,30	6000	66	135	115
TL-KL2-24 x 28	24 x 28	5,30	6,30	6130	73	130	110
TL-KL2-25 x 30	25 x 30	5,30	6,30	5770	72	115	95
TL-KL2-28 x 32	28 x 32	5,30	6,30	6330	86	115	100
TL-KL2-30 x 35	30 x 35	5,30	6,30	6080	91	100	85
TL-KL2-32 x 36	32 x 36	5,30	6,30	8240	131	130	115
TL-KL2-35 x 40	35 x 40	6,00	7,00	9770	171	125	110
TL-KL2-36 x 42	36 x 42	6,00	7,00	9390	169	115	100
TL-KL2-36 x 44	36 x 44	6,00	7,00	9550	181	110	95
TL-KL2-40 x 45	40 x 45	6,60	8,00	11570	231	115	105
TL-KL2-42 x 48	42 x 48	6,60	8,00	11220	235	110	95
TL-KL2-45 x 52	45 x 52	8,60	10,00	15710	353	105	95
TL-KL2-48 x 55	48 x 55	8,60	10,00	23840	572	155	135
TL-KL2-50 x 57	50 x 57	8,60	10,00	24080	602	150	130
TL-KL2-55 x 62	55 x 62	8,60	10,00	24350	670	140	125
TL-KL2-56 x 64	56 x 64	10,40	12,00	28200	790	130	115
TL-KL2-60 x 68	60 x 68	10,40	12,00	28600	860	125	110
TL-KL2-63 x 71	63 x 71	10,40	12,00	28800	910	120	105
TL-KL2-65 x 73	65 x 73	10,40	12,00	29200	950	115	100
TL-KL2-70 x 79	70 x 79	12,20	14,00	39400	1380	125	110
TL-KL2-71 x 80	71 x 80	12,20	14,00	39400	1400	120	110
TL-KL2-75 x 84	75 x 84	12,20	14,00	38600	1450	115	100
TL-KL2-80 x 91	80 x 91	15,00	17,00	55000	2200	125	105
TL-KL2-85 x 96	85 x 96	15,00	17,00	56400	2400	120	105
TL-KL2-90 x 101	90 x 101	15,00	17,00	60500	2730	120	105
TL-KL2-95 x 106	95 x 106	15,00	17,00	64200	3050	120	110
TL-KL2-100 x 114	100 x 114	18,70	21,00	84000	4200	120	105
TL-KL2-110 x 124	110 x 124	18,70	21,00	83600	5150	120	105
TL-KL2-120 x 134	120 x 134	18,70	21,00	100800	6050	120	105
TL-KL2-130 x 148	130 x 148	25,30	28,00	147600	9600	120	105
TL-KL2-140 x 158	140 x 158	25,30	28,00	158500	11000	120	105
TL-KL2-150 x 168	150 x 168	25,30	28,00	172000	12900	120	105
TL-KL2-160 x 178	160 x 178	25,30	28,00	182500	14600	120	110

NEXT >



REFERENCE	DIMENSIONS			THRUST	TORQUE	PRESSION	
	d x D mm	L1 mm	B mm	Ft	Mt	Pw	Pn
TL-KL2-170 x 191	170 x 191	30,00	33,00	229000	19500	120	105
TL-KL2-180 x 201	180 x 201	30,00	33,00	236000	21300	120	105
TL-KL2-190 x 211	190 x 211	30,00	33,00	255000	24200	120	105
TL-KL2-200 x 224	200 x 224	34,80	38,00	310000	31000	120	105
TL-KL2-210 x 224	210 x 224	34,80	38,00	333000	35000	120	110
TL-KL2-220 x 244	220 x 244	34,80	38,00	345000	38000	120	110
TL-KL2-230 x 257	230 x 257	39,50	43,00	408000	47000	120	105
TL-KL2-240 x 267	240 x 267	39,50	43,00	425000	51000	120	110
TL-KL2-250 x 280	250 x 280	44,00	48,00	415000	52000	100	90
TL-KL2-260 x 290	260 x 290	44,00	48,00	435000	56500	100	90
TL-KL2-270 x 300	270 x 300	44,00	48,00	450000	61000	100	90
TL-KL2-280 x 313	280 x 313	49,00	53,00	520000	72500	100	90
TL-KL2-290 x 323	290 x 323	49,00	53,00	535000	77500	100	90
TL-KL2-300 x 333	300 x 333	53,00	49,00	555000	83000	100	90
TL-KL2-320 x 360	320 x 360	65,00	59,00	710000	114000	100	90
TL-KL2-340 x 380	340 x 380	65,00	59,00	755000	128500	100	90
TL-KL2-360 x 400	360 x 400	65,00	59,00	800000	144000	100	90
TL-KL2-380 x 420	380 x 420	65,00	59,00	845000	160500	100	90
TL-KL2-400 x 440	400 x 440	65,00	59,00	890000	178000	100	90
TL-KL2-420 x 460	420 x 460	65,00	59,00	935000	196000	100	90
TL-KL2-440 x 480	440 x 480	65,00	59,00	980000	215000	100	90
TL-KL2-460 x 500	460 x 500	65,00	59,00	1020000	235000	100	90
TL-KL2-480 x 520	480 x 520	65,00	59,00	1070000	256000	100	90
TL-KL2-500 x 540	500 x 540	65,00	59,00	1110000	278000	100	90
TL-KL2-520 x 570	520 x 570	80,00	73,00	1430000	372000	100	90
TL-KL2-540 x 590	540 x 590	80,00	73,00	1480000	400000	100	90

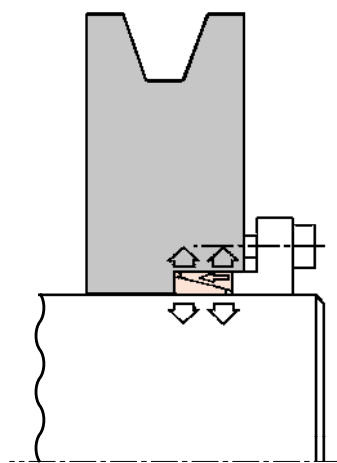

Application on a Pulley

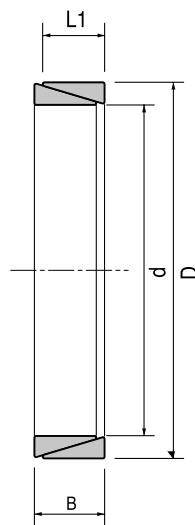

SERIES TL-LOCK3

Consists of two tapered rings and a spacer. Has a very small overall dimensions due to the reduced thickness of the cone rings. Recommended for medium torques. Self centering. Suits very well for axial

positioning as there is no axial displacement at the time of assembling.

Available for shafts diameters from 6 to 130 mm.

REFERENCE	DIMENSIONS					THRUST Ft	TORQUE Mt	PRESSION		CLAMPING BOLTS		
	d x D mm	L1 mm	L3 mm	B mm	D1 mm			Pw	Pn	Qty	Size	Ms
TL-KL3-6 x 14	6 x 14	10	21	24	25	4500	13	190	80	3	M3	2,0
TL-KL3-7 x 15	7 x 15	12	25	29	27	6500	24	230	110	3	M4	4,9
TL-KL3-8 x 15	8 x 15	12	25	29	27	6650	25	210	110	3	M4	4,9
TL-KL3-9 x 16	9 x 16	14	26	30	28	9980	45	210	120	4	M4	4,9
TL-KL3-10 x 16	10 x 16	14	26	30	28	9980	49	190	120	4	M4	4,9
TL-KL3-11 x 18	11 x 18	14	26	30	32	9980	54	170	105	4	M4	4,9
TL-KL3-12 x 18	12 x 18	14	26	30	32	9980	60	155	105	4	M4	4,9
TL-KL3-13 x 23	13 x 23	14	26	30	38	9980	63	145	85	4	M4	4,9
TL-KL3-14 x 23	14 x 23	14	26	30	38	9980	70	135	85	4	M4	4,9
TL-KL3-15 x 24	15 x 24	16	36	42	45	17100	120	185	120	3	M6	17,0
TL-KL3-16 x 24	16 x 24	16	36	42	45	17100	140	180	120	3	M6	17,0
TL-KL3-17 x 26	17 x 26	18	38	44	47	22000	180	190	125	4	M6	17,0
TL-KL3-18 x 26	18 x 26	18	38	44	47	22000	200	180	125	4	M6	17,0
TL-KL3-19 x 27	19 x 27	18	38	44	49	22000	210	170	120	4	M6	17,0
TL-KL3-20 x 28	20 x 28	18	38	44	50	22000	220	160	115	4	M6	17,0
TL-KL3-22 x 32	22 x 32	25	45	51	54	22000	250	115	80	4	M6	17,0
TL-KL3-24 x 34	24 x 34	25	45	51	56	22000	270	105	75	4	M6	17,0
TL-KL3-25 x 34	25 x 34	25	45	51	56	22000	280	100	75	4	M6	17,0
TL-KL3-28 x 39	28 x 39	25	45	51	61	33000	465	135	100	6	M6	17,0
TL-KL3-30 x 41	30 x 41	25	45	51	62	33000	510	125	90	6	M6	17,0
TL-KL3-32 x 43	32 x 43	25	45	51	65	33000	540	120	90	6	M6	17,0
TL-KL3-35 x 47	35 x 47	32	52	58	69	45000	790	105	80	8	M6	17,0
TL-KL3-38 x 50	38 x 50	32	52	58	72	45000	860	100	75	8	M6	17,0
TL-KL3-40 x 53	40 x 53	32	58	58	75	45000	900	95	70	8	M6	17,0
TL-KL3-42 x 55	42 x 55	32	52	58	78	45000	950	90	70	8	M6	17,0
TL-KL3-45 x 59	45 x 59	45	70	78	86	84000	1890	110	85	8	M8	41,0
TL-KL3-48 x 62	48 x 62	45	70	78	87	84000	2010	105	80	8	M8	41,0
TL-KL3-50 x 65	50 x 65	45	70	78	92	84000	2100	100	75	8	M8	41,0
TL-KL3-55 x 71	55 x 71	55	80	88	98	94000	2600	85	65	9	M8	41,0
TL-KL3-60 x 77	60 x 77	55	80	88	104	94000	2840	75	60	9	M8	41,0
TL-KL3-65 x 84	65 x 84	55	80	88	111	94000	3070	70	55	9	M8	41,0
TL-KL3-70 x 90	70 x 90	65	96	106	119	150000	5250	90	70	9	M10	83,0
TL-KL3-75 x 95	75 x 95	65	96	106	126	150000	5600	80	65	9	M10	83,0
TL-KL3-80 x 100	80 x 100	65	96	106	131	200000	8020	100	80	12	M10	83,0
TL-KL3-85 x 106	85 x 106	65	96	106	137	200000	8500	95	75	12	M10	83,0
TL-KL3-90 x 112	90 x 112	65	96	106	144	200000	9000	90	75	12	M10	83,0
TL-KL3-95 x 120	95 x 120	65	96	106	149	230000	11000	100	80	14	M10	83,0
TL-KL3-100 x 125	100 x 125	65	96	106	154	300000	15000	120	95	18	M10	83,0
TL-KL3-110 x 140	110 x 140	90	128	140	180	290000	16000	80	65	12	M12	145,0
TL-KL3-120 x 155	120 x 155	90	128	140	198	290000	17500	70	55	12	M12	145,0
TL-KL3-130 x 165	130 x 165	90	128	140	208	384000	25000	90	70	16	M12	145,0

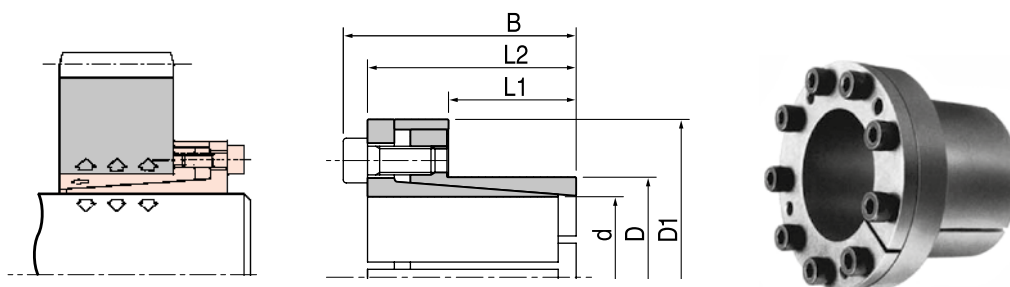

SERIES TL-LOCK4

Consists of two cone rings one inside and one outside.
Self centering. Recommended for high torques to be transmitted.
Not suitable for applications needing a highly precise axial position.
Available for shafts diameters from 20 up to 180 mm.

Easily assembled and disassembled.
To assemble, once the shaft and hub surfaces are clean, insert the

unit into the hub and enter the shaft. Tighten the screws until inner ring contracts grasping the shaft and the outer ring expands and grip the hub bore. Tight the screws following a star-like sequence until reaching to the Ms torque as in the table.

To disassemble, simply loosen the tightening screws. Refer to the general directions in page for assembling and disassembling.

REFERENCE	DIMENSIONS					THRUST Ft	TORQUE Mt	PRESSION		CLAMPING BOLTS DIN912-12.9		
	d x D mm	L1 mm	L2 mm	L3 mm	B mm			Pw	Pn	Qty	Size	Ms
TL-KL4-20 x 47	20 x 47	26	29,00	42,00	48,00	54000	540	250	105	6	M6	17
TL-KL4-22 x 47	22 x 47	26	29,00	42,00	48,00	54000	600	230	105	6	M6	17
TL-KL4-24 x 50	24 x 50	26	29,00	42,00	48,00	54000	650	210	100	6	M6	17
TL-KL4-25 x 50	25 x 50	26	29,00	42,00	48,00	54000	680	200	100	6	M6	17
TL-KL4-28 x 55	28 x 55	26	29,00	42,00	48,00	54000	760	180	95	6	M6	17
TL-KL4-30 x 55	30 x 55	26	29,00	42,00	48,00	54000	820	170	95	6	M6	17
TL-KL4-32 x 60	32 x 60	26	29,00	42,00	48,00	82000	1310	235	125	9	M6	17
TL-KL4-35 x 60	35 x 60	26	29,00	42,00	48,00	82000	1440	215	125	9	M6	17
TL-KL4-38 x 65	38 x 65	26	29,00	42,00	48,00	82000	1560	200	115	9	M6	17
TL-KL4-40 x 65	40 x 65	26	29,00	42,00	48,00	82000	1640	190	115	9	M6	17
TL-KL4-42 x 75	42 x 75	30	34,40	51,00	59,00	101000	2130	215	120	6	M8	41
TL-KL4-45 x 75	45 x 75	30	34,40	51,00	59,00	101000	2280	200	120	6	M8	41
TL-KL4-48 x 80	48 x 80	30	34,40	51,00	59,00	101000	2430	190	115	6	M8	41
TL-KL4-50 x 80	50 x 80	30	34,40	51,00	59,00	101000	2530	180	115	6	M8	41
TL-KL4-55 x 85	55 x 85	30	34,40	51,00	59,00	152000	4180	245	160	9	M8	41
TL-KL4-60 x 90	60 x 90	30	34,40	51,00	59,00	152000	4560	225	150	9	M8	41
TL-KL4-65 x 95	65 x 95	30	34,40	51,00	59,00	152000	4940	210	145	9	M8	41
TL-KL4-70 x 110	70 x 110	40	45,00	56,00	66,00	186000	6500	175	110	7	M10	83
TL-KL4-75 x 115	75 x 115	40	45,00	56,00	66,00	186000	9000	165	110	7	M10	83
TL-KL4-80 x 120	80 x 120	40	45,00	56,00	66,00	186000	7400	155	100	7	M10	83
TL-KL4-85 x 125	85 x 125	40	45,00	56,00	66,00	213000	9000	170	115	8	M10	83
TL-KL4-90 x 130	90 x 130	40	45,00	56,00	66,00	213000	9600	160	110	8	M10	83
TL-KL4-95 x 135	95 x 135	40	45,00	56,00	66,00	267000	12600	185	130	10	M10	83
TL-KL4-100 x 145	100 x 145	46	52,00	65,00	77,00	270000	13300	160	105	7	M12	145
TL-KL4-110 x 155	110 x 155	46	52,00	65,00	77,00	270000	14700	140	100	7	M12	145
TL-KL4-120 x 165	120 x 165	46	52,00	65,00	77,00	309000	18400	150	110	8	M12	145
TL-KL4-130 x 180	130 x 180	46	52,00	65,00	77,00	388000	25100	175	125	10	M12	145
TL-KL4-140 x 190	140 x 190	51	58,50	73,50	87,50	586000	40150	220	160	11	M14	230
TL-KL4-150 x 200	150 x 200	51	58,50	73,50	87,50	639000	47000	225	165	12	M14	230
TL-KL4-160 x 210	160 x 210	51	58,50	73,50	87,50	692000	54300	225	170	13	M14	230
TL-KL4-170 x 225	170 x 225	51	58,50	73,50	87,50	746000	63000	230	175	14	M14	230
TL-KL4-180 x 235	180 x 235	51	58,50	73,50	87,50	746000	66000	215	170	14	M14	230

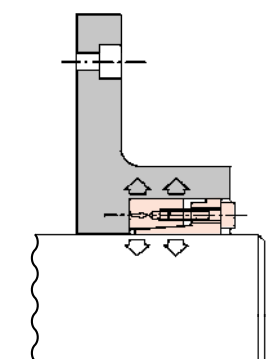

Application on a Plate

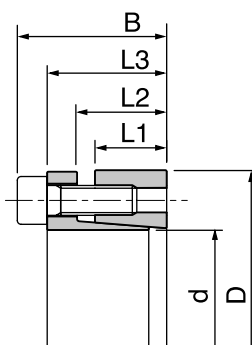

SERIES TL-LOCK5

Consists of two cones one outside and one inside joined together by means of a set of screws and a stop ring. Recommended for medium torques. Self centering.

Permits a high precision axial positioning as no axial displacement occurs during assembly. Available for shafts diameters from 20 to 180 mm.

Easily assembled and disassembled.

To assemble, once the shaft and hub surfaces are clean, insert the unit into the hub and enter the shaft. Tighten the screws until inner ring contracts grasping the shaft and the outer ring expands and grip the hub bore. Tight the screws following a star-like sequence until reaching to the Ms torque as in the table.

To disassemble, simply loosen the tightening screws. Refer to the general directions in page for assembling and disassembling.

REFERENCE	DIMENSIONS						THRUST Ft	TORQUE Mt	PRESSION		CLAMPING BOLTS DIN912-12.9		
	d x D mm	L1 mm	L2 mm	L3 mm	B mm	D1 mm			Pw	Pn	Qty	Size	Ms
TL-KL5-20 x 47	20 x 47	26	29,00	42,00	48,00	53	33600	330	155	65	6	M6	17
TL-KL5-22 x 47	22 x 47	26	29,00	42,00	48,00	53	33600	370	145	65	6	M6	17
TL-KL5-24 x 50	24 x 50	26	29,00	42,00	48,00	56	33600	400	140	60	6	M6	17
TL-KL5-25 x 50	25 x 50	26	29,00	42,00	48,00	56	33600	420	125	60	6	M6	17
TL-KL5-28 x 55	28 x 55	26	29,00	42,00	48,00	61	33600	470	110	60	6	M6	17
TL-KL5-30 x 55	30 x 55	26	29,00	42,00	48,00	61	33600	510	105	60	6	M6	17
TL-KL5-32 x 60	32 x 60	26	29,00	42,00	48,00	66	51000	810	145	80	9	M6	17
TL-KL5-35 x 60	35 x 60	26	29,00	42,00	48,00	66	51000	890	135	80	9	M6	17
TL-KL5-38 x 65	38 x 65	26	29,00	42,00	48,00	71	51000	970	125	70	9	M6	17
TL-KL5-40 x 65	40 x 65	26	29,00	42,00	48,00	71	51000	1020	120	70	9	M6	17
TL-KL5-42 x 75	42 x 75	26	34,40	42,00	48,00	81	62800	1320	135	75	6	M8	41
TL-KL5-45 x 75	45 x 75	30	34,40	51,00	59,00	81	62800	1410	125	75	6	M8	41
TL-KL5-48 x 80	48 x 80	30	34,40	51,00	59,00	86	62800	1510	120	70	6	M8	41
TL-KL5-50 x 80	50 x 80	30	34,40	51,00	59,00	86	62800	1570	110	70	6	M8	41
TL-KL5-55 x 85	55 x 85	30	34,40	51,00	59,00	91	94600	2600	150	100	9	M8	41
TL-KL5-60 x 90	60 x 90	30	34,40	51,00	59,00	96	94600	2830	140	95	9	M8	41
TL-KL5-65 x 95	65 x 95	30	34,40	51,00	59,00	102	94600	3070	130	90	9	M8	41
TL-KL5-70 x 110	70 x 110	40	45,00	56,00	66,00	117	116000	4000	110	70	7	M10	83
TL-KL5-75 x 115	75 x 115	40	45,00	56,00	66,00	122	116000	4300	100	65	7	M10	83
TL-KL5-80 x 120	80 x 120	40	45,00	56,00	66,00	127	116000	4600	100	65	7	M10	83
TL-KL5-85 x 125	85 x 125	40	45,00	56,00	66,00	132	133000	5600	105	70	8	M10	83
TL-KL5-90 x 130	90 x 130	40	45,00	56,00	66,00	137	133000	6000	100	70	8	M10	83
TL-KL5-95 x 135	95 x 135	40	45,00	56,00	66,00	142	166800	7900	115	80	10	M10	83
TL-KL5-100 x 145	100 x 145	46	52,00	65,00	77,00	153	169000	8470	100	65	7	M12	145
TL-KL5-110 x 155	110 x 155	46	52,00	65,00	77,00	163	169000	9200	90	65	7	M12	145
TL-KL5-120 x 165	120 x 165	46	52,00	65,00	77,00	173	193000	11600	90	70	8	M12	145
TL-KL5-130 x 180	130 x 180	46	52,00	65,00	77,00	188	242000	15700	110	80	10	M12	145
TL-KL5-140 x 190	140 x 190	51	58,50	73,50	87,50	199	366000	25300	135	10	11	M14	230
TL-KL5-150 x 200	150 x 200	51	58,50	73,50	87,50	209	399000	29500	140	105	12	M14	230
TL-KL5-160 x 210	160 x 210	51	58,50	73,50	87,50	219	432000	31900	140	110	13	M14	230
TL-KL5-170 x 225	170 x 225	51	58,50	73,50	87,50	234	466000	39500	145	110	14	M14	230
TL-KL5-180 x 235	180 x 235	51	58,50	73,50	87,50	244	466000	41500	135	105	14	M14	230

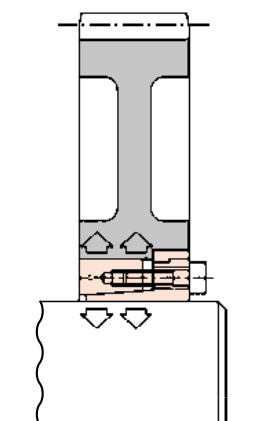

Application on a Gear

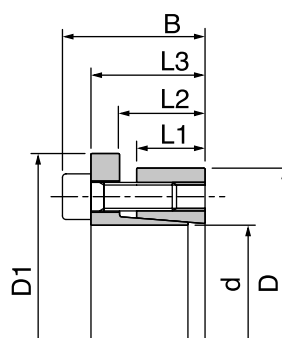

SERIES TL-LOCK6

Consists of two cone rings one inside and one outside, joined by a set of screws. Not suitable for applications with precise axial precision position as to small axial displacement of the hub during assembly.

bly. Self centering.
Suitable for applications with medium torques.
Available for shaft diameters from 20 to 200 mm.

REFERENCE	DIMENSIONS					THRUST Ft	TORQUE Mt	PRESSION		CLAMPING BOLTS DIN912-12.9		
	d x D mm	L1 mm	L2 mm	L3 mm	B mm			Pw	Pn	Qty	Size	Ms
TL-KL6-20 x 47	20 x 47	17	22,00	28,00	34,00	38,00	0,38	295	125	5	M6	14
TL-KL6-22 x 47	22 x 47	17	22,00	28,00	34,00	38,00	0,41	270	125	5	M6	14
TL-KL6-24 x 50	24 x 50	17	22,00	28,00	34,00	38,00	0,45	245	120	5	M6	14
TL-KL6-25 x 50	25 x 50	17	22,00	28,00	34,00	45,60	0,57	285	140	6	M6	14
TL-KL6-28 x 55	28 x 55	17	22,00	28,00	34,00	45,60	0,63	255	130	6	M6	14
TL-KL6-30 x 55	30 x 55	17	22,00	28,00	34,00	45,60	0,66	235	130	6	M6	14
TL-KL6-32 x 60	32 x 60	17	22,00	28,00	34,00	60,50	0,97	295	155	8	M6	14
TL-KL6-35 x 60	35 x 60	17	22,00	28,00	34,00	60,50	1,06	270	155	8	M6	14
TL-KL6-38 x 65	38 x 65	17	22,00	28,00	34,00	60,50	1,15	250	145	8	M6	14
TL-KL6-40 x 65	40 x 65	17	22,00	28,00	34,00	60,50	1,21	235	145	8	M6	14
TL-KL6-42 x 75	42 x 75	20	25,00	33,00	41,00	98,00	2,05	300	170	7	M8	35
TL-KL6-45 x 75	45 x 75	20	25,00	33,00	41,00	98,00	2,20	290	170	7	M8	35
TL-KL6-48 x 80	48 x 80	20	25,00	33,00	41,00	98,00	2,35	270	160	7	M8	35
TL-KL6-50 x 80	50 x 80	20	25,00	33,00	41,00	98,00	2,45	260	160	7	M8	35
TL-KL6-55 x 85	55 x 85	20	25,00	33,00	41,00	112,00	3,08	270	175	8	M8	35
TL-KL6-60 x 90	60 x 90	20	25,00	33,00	41,00	112,00	3,36	245	165	8	M8	35
TL-KL6-65 x 95	65 x 95	20	25,00	33,00	41,00	126,00	4,09	255	175	9	M8	35
TL-KL6-70 x 110	70 x 110	24	30,00	40,00	50,00	179,00	6,30	280	180	8	M10	70
TL-KL6-75 x 115	75 x 115	24	30,00	40,00	50,00	179,00	6,70	260	170	8	M10	70
TL-KL6-80 x 120	80 x 120	24	30,00	40,00	50,00	179,00	7,15	250	170	8	M10	70
TL-KL6-85 x 125	85 x 125	24	30,00	40,00	50,00	200,00	8,50	260	180	9	M10	70
TL-KL6-90 x 130	90 x 130	24	30,00	40,00	50,00	200,00	9,10	250	170	9	M10	70
TL-KL6-95 x 135	95 x 135	24	30,00	40,00	50,00	224,00	10,60	260	180	10	M10	70
TL-KL6-100 x 145	100 x 145	26	32,00	44,00	56,00	268,00	13,40	270	190	8	M12	125
TL-KL6-110 x 155	110 x 155	26	32,00	44,00	56,00	268,00	14,60	240	180	8	M12	125
TL-KL6-120 x 165	120 x 165	26	32,00	44,00	56,00	298,00	17,90	250	180	9	M12	125
TL-KL6-130 x 180	130 x 180	34	40,00	56,00	64,00	400,00	26,00	240	170	12	M12	125
TL-KL6-140 x 190	140 x 190	34	40,00	54,00	68,00	384,00	27,00	210	150	9	M14	190
TL-KL6-150 x 200	150 x 200	34	40,00	54,00	68,00	440,00	33,00	230	170	10	M14	190
TL-KL6-160 x 210	160 x 210	34	40,00	54,00	68,00	479,00	38,00	230	170	11	M14	190
TL-KL6-170 x 225	170 x 225	44	50,00	64,00	78,00	530,00	45,00	180	130	12	M14	190
TL-KL6-180 x 235	180 x 235	44	50,00	64,00	78,00	530,00	47,00	170	130	12	M14	190
TL-KL6-190 x 250	190 x 250	44	50,00	64,00	78,00	660,00	62,90	210	150	15	M14	190
TL-KL6-200 x 260	200 x 260	44	50,00	64,00	78,00	660,00	66,00	190	150	15	M14	190

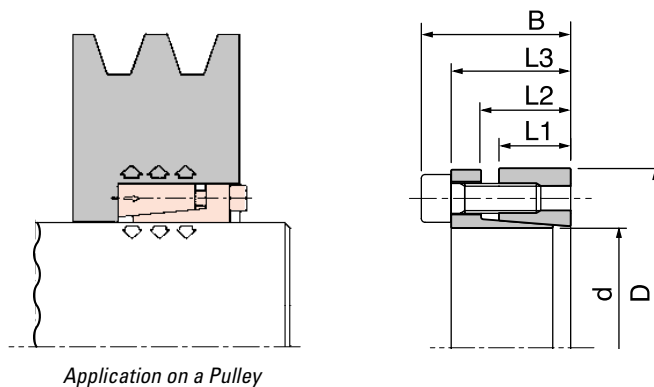

SERIES TL-LOCK7

Consists of two cone rings one inside and one outside joined together by a set of screws. The inner ring has a larger diameter flange which pushes against the hub wall. It has a very small axial dimen-

sion. Self centering. Suitable for applications with medium torques needing a precise axial position.

Available for shaft diameters from 20 to 200 mm.

REFERENCE	DIMENSIONS						THRUST Ft	TORQUE Mt	PRESSION		CLAMPING BOLTS DIN912-12.9		
	d x D mm	L1 mm	L2 mm	L3 mm	B mm	D1 mm			Pw	Pn	Qty	Size	Ms
TL-KL7-20 x 47	20 x 47	17	22,00	28,00	34,00	56	28000	280	220	95	5	M6	17
TL-KL7-22 x 47	22 x 47	17	22,00	28,00	34,00	56	28000	300	200	95	5	M6	17
TL-KL7-24 x 50	24 x 50	17	22,00	28,00	34,00	59	28000	330	180	90	5	M6	17
TL-KL7-25 x 50	25 x 50	17	22,00	28,00	34,00	59	34000	420	210	105	6	M6	17
TL-KL7-28 x 55	28 x 50	17	22,00	28,00	34,00	64	34000	470	190	95	6	M6	17
TL-KL7-30 x 55	30 x 55	17	22,00	28,00	34,00	64	34000	500	175	95	6	M6	17
TL-KL7-32 x 60	32 x 60	17	22,00	28,00	34,00	69	45000	720	220	115	8	M6	17
TL-KL7-35 x 60	35 x 60	17	22,00	28,00	34,00	69	45000	790	200	115	8	M6	17
TL-KL7-38 x 65	38 x 65	17	22,00	28,00	34,00	74	45000	850	185	105	8	M6	17
TL-KL7-40 x 65	40 x 65	17	22,00	28,00	34,00	74	45000	900	175	105	8	M6	17
TL-KL7-42 x 75	42 x 75	20	25,00	33,00	41,00	84	73000	1530	225	125	7	M8	41
TL-KL7-45 x 75	45 x 75	20	25,00	33,00	41,00	84	73000	1650	215	125	7	M8	41
TL-KL7-48 x 80	48 x 80	20	25,00	33,00	41,00	89	73000	1760	200	120	7	M8	41
TL-KL7-50 x 80	50 x 80	20	25,00	33,00	41,00	89	73000	1830	195	120	7	M8	41
TL-KL7-55 x 85	55 x 85	20	25,00	33,00	41,00	94	83500	2300	200	130	8	M10	83
TL-KL7-60 x 90	60 x 90	20	25,00	33,00	41,00	99	83500	2510	185	125	8	M8	41
TL-KL7-65 x 95	65 x 95	20	25,00	33,00	41,00	104	94000	3060	190	130	9	M8	41
TL-KL7-70 x 110	70 x 110	20	30,00	33,00	41,00	119	133000	4670	210	135	8	M10	83
TL-KL7-75 x 115	75 x 115	24	30,00	40,00	50,00	124	133000	5000	195	125	8	M10	83
TL-KL7-80 x 120	80 x 120	24	30,00	40,00	50,00	129	133000	5300	185	125	8	M10	83
TL-KL7-85 x 125	85 x 125	24	30,00	40,00	50,00	134	148000	6300	195	135	9	M10	83
TL-KL7-90 x 130	90 x 130	24	30,00	40,00	50,00	139	148000	6750	185	130	9	M10	83
TL-KL7-95 x 135	95 x 135	24	30,00	40,00	50,00	144	166000	7900	195	135	10	M10	83
TL-KL7-100 x 145	100 x 145	26	32,00	44,00	56,00	154	194000	9700	200	140	8	M12	145
TL-KL7-110 x 155	110 x 155	26	32,00	44,00	56,00	164	194000	10600	180	130	8	M12	145
TL-KL7-120 x 165	120 x 165	26	40,00	44,00	56,00	174	216000	13000	185	135	9	M12	145
TL-KL7-130 x 180	130 x 180	34	40,00	54,00	64,00	189	290000	18900	175	125	12	M12	145
TL-KL7-140 x 190	140 x 190	34	40,00	54,00	68,00	199	290000	20500	165	120	9	M14	230
TL-KL7-150 x 200	150 x 200	34	40,00	54,00	68,00	209	333000	25000	175	130	10	M14	230
TL-KL7-160 x 210	160 x 210	34	40,00	54,00	68,00	219	362000	29000	180	135	11	M14	230
TL-KL7-170 x 225	170 x 225	44	50,00	64,00	78,00	234	400000	34000	140	105	12	M14	230
TL-KL7-180 x 235	180 x 235	44	50,00	64,00	78,00	244	400000	36000	135	105	12	M14	230
TL-KL7-190 x 250	190 x 250	44	50,00	64,00	78,00	259	500000	47500	160	120	15	M14	230
TL-KL7-200 x 260	200 x 260	44	50,00	64,00	78,00	269	500000	50000	150	115	15	M14	230

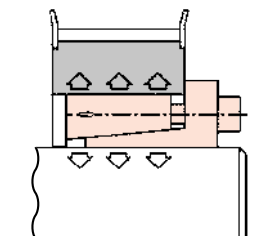

Application on a Timing Pulley

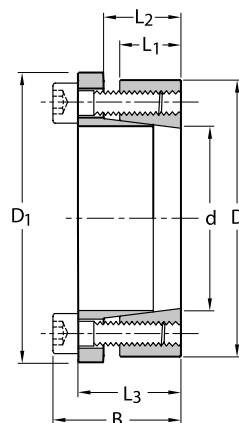

SERIES TL-LOCK8

Consists of two cone rings one inside and one inside joint together by means of a set of screws. The inner ring has a larger diameter flange which pushes against the hub wall. Suitable for very small

axial dimensions and applications with a very precise axial position and medium torques.

Available for shaft diameters from 14 to 50 mm.

REFERENCE	DIMENSIONS					THRUST Ft	TORQUE Mt	PRESSION		CLAMPING BOLTS DIN912-12.9		
	d x D mm	L1 mm	L2 mm	L3 mm	B mm			Pw	Pn	Qty	Size	Ms
TL-KL8-14 x 55	14 x 55	17	30,00	38,00	62,00	18100	120	205	55	3	M8	25
TL-KL8-16 x 55	16 x 55	17	30,00	38,00	62,00	18100	140	180	55	3	M8	25
TL-KL8-18 x 55	18 x 55	17	30,00	38,00	62,00	18100	150	160	55	3	M8	25
TL-KL8-19 x 55	19 x 55	17	30,00	38,00	62,00	18100	160	150	55	3	M8	25
TL-KL8-20 x 55	20 x 55	17	30,00	38,00	62,00	18100	170	145	55	3	M8	25
TL-KL8-22 x 55	22 x 55	17	30,00	38,00	62,00	25300	280	185	75	3	M8	35
TL-KL8-24 x 55	24 x 55	17	30,00	38,00	62,00	25300	300	170	75	3	M8	35
TL-KL8-25 x 55	25 x 55	17	30,00	38,00	62,00	25300	310	165	75	3	M8	35
TL-KL8-28 x 55	28 x 55	17	30,00	38,00	62,00	31400	430	175	90	3	M8	41
TL-KL8-30 x 55	30 x 55	17	30,00	38,00	62,00	31400	470	165	90	3	M8	41
TL-KL8-24 x 65	24 x 65	17	30,00	38,00	72,00	37400	440	245	90	5	M8	30
TL-KL8-25 x 65	25 x 65	17	30,00	38,00	72,00	37400	460	235	90	5	M8	30
TL-KL8-28 x 65	28 x 65	17	30,00	38,00	72,00	43600	600	245	105	5	M8	35
TL-KL8-30 x 65	30 x 65	17	30,00	38,00	72,00	43600	640	230	105	5	M8	35
TL-KL8-32 x 65	32 x 65	17	30,00	38,00	72,00	43600	690	215	105	5	M8	35
TL-KL8-35 x 65	35 x 65	17	30,00	38,00	72,00	52500	910	235	130	5	M8	41
TL-KL8-38 x 65	38 x 65	17	30,00	38,00	72,00	52500	990	220	130	5	M8	41
TL-KL8-40 x 65	40 x 65	17	30,00	38,00	72,00	52500	1050	205	130	5	M8	41
TL-KL8-30 x 80	30 x 80	20	33,00	41,00	87,00	52400	780	235	90	7	M8	30
TL-KL8-32 x 80	32 x 80	20	33,00	41,00	87,00	52400	830	220	90	7	M8	30
TL-KL8-35 x 80	35 x 80	20	33,00	41,00	87,00	61000	1060	230	100	7	M8	35
TL-KL8-38 x 80	38 x 80	20	33,00	41,00	87,00	61000	1150	215	100	7	M8	35
TL-KL8-40 x 80	40 x 80	20	33,00	41,00	87,00	61000	1220	205	100	7	M8	35
TL-KL8-42 x 80	42 x 80	20	33,00	41,00	87,00	73500	1540	235	120	7	M8	41
TL-KL8-45 x 80	45 x 80	20	33,00	41,00	87,00	73500	1650	220	120	7	M8	41
TL-KL8-48 x 80	48 x 80	20	33,00	41,00	87,00	73500	1760	205	120	7	M8	41
TL-KL8-50 x 80	50 x 80	20	33,00	41,00	87,00	73500	1830	195	120	7	M8	41

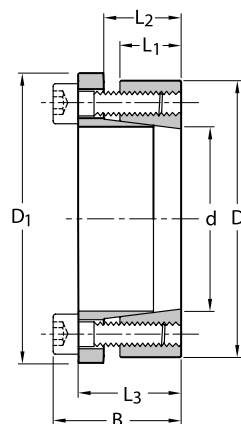
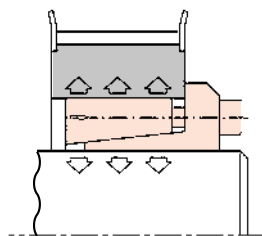

SERIES TL-LOCK9

Suitable for small and medium torque applications. Shaft diameters from 14 to 70 mm. Based on two cone rings and a tab washer.

REFERENCE	DIMENSIONS				TORQUE	THRUST	PRESSION		NUT	Ms
	d x D mm	D1 mm	L mm	B mm			Pw	Pn		
TL-KL9-14 x 25	14 x 25	32	6,50	16,5	38	5100	200	110	KM4	95
TL-KL9-15 x 25	15 x 25	32	6,50	16,50	41	5500	185	110	KM4	95
TL-KL9-16 x 25	16 x 25	32	6,50	16,50	43	5450	174	110	KM4	95
TL-KL9-17 x 26	17 x 26	32	6,50	16,50	47	5500	164	107	KM4	95
TL-KL9-18 x 26	18 x 26	32	6,50	18,00	49	5400	155	107	KM4	95
TL-KL9-19 x 30	19 x 30	38	6,50	18,00	62	6600	176	112	KM5	160
TL-KL9-20 x 30	20 x 30	38	6,50	18,00	66	6600	167	111	KM5	160
TL-KL9-22 x 32	22 x 32	38	6,50	18,00	73	6600	152	105	KM5	160
TL-KL9-24 x 35	24 x 35	45	6,50	18,00	105	8750	185	127	KM6	220
TL-KL9-25 x 35	25 x 35	45	6,50	18,00	110	8800	178	127	KM6	220
TL-KL9-28 x 36	28 x 36	45	6,50	19,50	120	8550	159	124	KM6	220
TL-KL9-30 x 40	30 x 40	52	6,50	19,50	160	10600	164	123	KM7	340
TL-KL9-32 x 42	32 x 42	52	7,00	21,50	170	10600	154	117	KM7	340
TL-KL9-35 x 45	35 x 45	58	8,00	21,50	230	13100	153	120	KM8	480
TL-KL9-36 x 45	36 x 45	58	8,00	21,50	240	13300	149	120	KM8	480
TL-KL9-38 x 48	38 x 48	58	8,00	24,50	250	13100	141	112	KM8	480
TL-KL9-40 x 52	40 x 52	65	10,00	25,50	310	15500	120	93	KM9	680
TL-KL9-42 x 55	42 x 55	65	10,00	25,50	320	15200	114	87	KM9	680
TL-KL9-45 x 57	45 x 57	70	10,00	25,50	400	17700	122	96	KM10	870
TL-KL9-48 x 62	48 x 62	75	10,00	25,50	500	20800	135	105	KM11	970
TL-KL9-50 x 62	50 x 62	75	10,00	25,50	520	20800	130	105	KM11	970
TL-KL9-55 x 68	55 x 68	80	12,00	27,50	610	22000	103	84	KM12	1100
TL-KL9-56 x 68	56 x 68	80	12,00	27,50	620	22000	101	82	KM12	1100
TL-KL9-60 x 73	60 x 73	85	12,00	28,50	800	26600	113	93	KM13	1300
TL-KL9-63 x 79	63 x 79	92	14,00	30,50	980	31100	107	86	KM14	1600
TL-KL9-65 x 79	65 x 79	92	14,00	30,50	1010	31000	104	86	KM14	1600
TL-KL9-70 x 84	70 x 84	98	14,00	31,50	1240	35400	110	92	KM15	2000

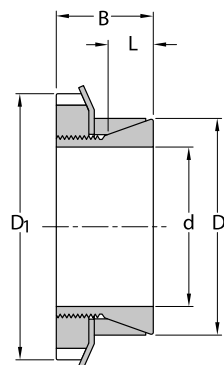

SERIES TL-LOCK10

This model works as a rigid coupling. Available for diameters from 17 to 80 mm. Available under MTO for shafts of different diameters.

To assemble, once the shafts surfaces are clean, fit the rigid coupling to the end of the shafts and tighten the screws in a star-like sequence

until arriving to the Ms torque value in the table.

To disassemble, simply loosen the tightening screws. Refer to the general directions in page for assembling and disassembling.

REFERENCE	DIMENSIONS			TORQUE Mt	THRUST Ft	CLAMPING BOLTS DIN912-129		
	d x D mm	L1 mm	L2 mm			Qty	Size	Ms
TL-KL10-17 x 50	17 x 50	50	56	210	24500	4	M6	17
TL-KL10-18 x 50	18 x 50	50	56	230	24500	4	M6	17
TL-KL10-19 x 50	19 x 50	50	56	240	24500	4	M6	17
TL-KL10-20 x 50	20 x 50	50	56	250	24500	4	M6	17
TL-KL10-22 x 55	22 x 55	60	66	270	24500	4	M6	17
TL-KL10-24 x 55	24 x 55	60	66	300	24500	4	M6	17
TL-KL10-25 x 55	25 x 55	60	66	460	36500	6	M6	17
TL-KL10-28 x 60	28 x 60	60	66	520	36500	6	M6	17
TL-KL10-30 x 60	30 x 60	60	66	560	36500	6	M6	17
TL-KL10-32 x 63	32 x 63	60	83	590	36500	6	M6	17
TL-KL10-35 x 75	35 x 75	75	83	770	45500	4	M8	41
TL-KL10-38 x 75	38 x 75	75	83	860	45500	4	M8	41
TL-KL10-40 x 75	40 x 75	75	83	910	45500	4	M8	41
TL-KL10-42 x 78	42 x 78	75	83	940	45500	4	M8	41
TL-KL10-45 x 85	45 x 85	85	93	1530	67500	6	M8	41
TL-KL10-48 x 90	48 x 90	85	93	1610	67500	6	M8	41
TL-KL10-50 x 90	50 x 90	85	93	1700	67500	6	M8	41
TL-KL10-55 x 94	55 x 94	85	93	2460	90500	8	M8	41
TL-KL10-60 x 100	60 x 100	85	93	2720	90500	8	M8	41
TL-KL10-65 x 105	65 x 105	85	93	2940	90500	8	M8	41
TL-KL10-70 x 115	70 x 115	100	110	3780	107500	6	M10	83
TL-KL10-75 x 125	75 x 125	100	110	4040	107500	6	M10	83
TL-KL10-80 x 125	80 x 125	100	110	4300	107500	6	M10	83

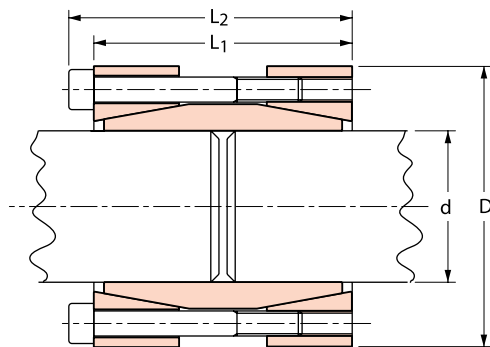

SERIES TL-LOCK11

Consists of two tapered inner flanges. Self centering.
Suitable for medium toques.

REFERENCE	DIMENSIONS					TORQUE Mt	THRUST Ft	PRESSURE		CLAMPING BOLTS DIN912-12.9		
	d x D mm	L mm	L1 mm	L2 mm	L3 mm			Pw	Pn	Qty	Size	Ms
TL-KL11-18 x 40	18 x 40	12	15	20	24	210	23700	235	130	6	M4	5
TL-KL11-19 x 41	19 x 41	12	15	20	24	220	23700	220	128	6	M4	5
TL-KL11-20 x 42	20 x 42	12	15	20	24	270	27700	245	145	7	M4	5
TL-KL11-22 x 44	22 x 44	12	15	20	24	300	27700	225	140	7	M4	5
TL-KL11-24 x 46	24 x 46	12	15	20	24	330	27700	205	135	7	M4	5
TL-KL11-25 x 47	25 x 47	12	15	20	24	340	27700	195	130	7	M4	5
TL-KL11-28 x 50	28 x 50	12	15	20	24	500	35600	225	155	9	M4	5
TL-KL11-30 x 52	30 x 52	12	15	20	24	530	35600	210	151	9	M4	5
TL-KL11-32 x 54	32 x 54	12	15	20	24	570	35600	197	146	9	M4	5
TL-KL11-35 x 57	35 x 57	16	19	24	28	690	39500	158	115	10	M4	5
TL-KL11-36 x 58	36 x 58	16	19	24	28	710	39500	155	113	10	M4	5
TL-KL11-38 x 60	38 x 60	16	19	24	28	830	43500	160	120	11	M4	5
TL-KL11-40 x 62	40 x 62	16	19	24	28	870	43500	150	116	11	M4	5
TL-KL11-42 x 70	42 x 70	19	23	30	36	1530	73000	200	146	8	M6	17
TL-KL11-45 x 73	45 x 73	19	23	30	36	1640	73000	185	140	8	M6	17
TL-KL11-48 x 76	48 x 76	19	23	30	36	1750	73000	175	134	8	M6	17
TL-KL11-50 x 78	50 x 78	19	23	30	36	1820	73000	165	131	8	M6	17
TL-KL11-55 x 83	55 x 83	19	23	30	36	2000	73000	150	123	8	M6	17
TL-KL11-56 x 84	56 x 84	19	23	30	36	2040	73000	150	120	8	M6	17
TL-KL11-60 x 88	60 x 88	19	23	30	36	2460	73000	158	130	9	M6	17
TL-KL11-63 x 91	63 x 91	19	23	30	36	2580	82100	150	125	9	M6	17
TL-KL11-65 x 93	65 x 93	19	23	30	36	2660	82100	140	120	9	M6	17
TL-KL11-70 x 105	70 x 105	23	28	37	45	4720	134800	180	148	8	M6	41
TL-KL11-75 x 110	75 x 110	23	28	37	45	5050	134800	170	140	8	M8	41
TL-KL11-80 x 115	80 x 115	23	28	37	45	5390	134800	160	135	8	M8	41
TL-KL11-85 x 120	85 x 120	23	28	37	45	5730	134800	150	130	8	M8	41
TL-KL11-90 x 125	90 x 125	23	28	37	45	7580	168500	170	156	10	M8	41

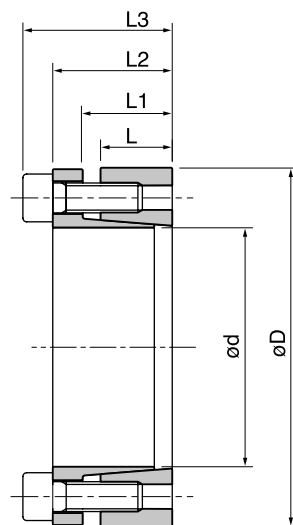

Consists of two cone rings joined together by a locking nut and a tab washer. Suitable for small and medium torques.

Available for shafts from 14 to 70 mm.

SERIES TL-LOCK12

Similar to TL-LOCK 9.

REFERENCE	DIMENSIONS				TORQUE Mt	THRUST Ft	PRESSION		NUT	Ms
	d x D mm	D1 mm	L mm	B mm			Pw	Pn		
TL-KL12-14 x 25	14 x 25	32	20	30	64	9000	85	45	KM4	95
TL-KL12-15 x 25	15 x 25	32	20	30	70	9000	80	45	KM4	95
TL-KL12-16 x 25	16 x 25	32	20	30	73	9000	75	45	KM4	95
TL-KL12-17 x 25	17 x 25	32	20	30	80	9000	70	45	KM4	160
TL-KL12-18 x 30	18 x 30	32	20	32	83	9000	65	40	KM4	160
TL-KL12-19 x 30	19 x 30	38	20	32	105	11000	75	45	KM5	160
TL-KL12-20 x 30	20 x 30	38	20	32	112	11000	70	42	KM5	160
TL-KL12-22 x 35	22 x 35	45	25	36	163	14000	70	45	KM6	220
TL-KL12-24 x 35	24 x 35	45	25	36	178	14000	65	45	KM6	220
TL-KL12-25 x 35	25 x 35	45	25	36	185	14000	60	45	KM6	220
TL-KL12-28 x 40	28 x 40	52	30	42	250	17000	55	40	KM7	340
TL-KL12-30 x 40	30 x 40	52	30	42	270	17000	50	40	KM7	340
TL-KL12-32 x 45	32 x 45	58	30	44	350	21000	60	45	KM8	480
TL-KL12-35 x 45	35 x 45	58	30	44	390	21000	55	45	KM8	480
TL-KL12-38 x 50	38 x 50	65	30	45	500	26000	60	45	KM9	680
TL-KL12-40 x 50	40 x 50	65	30	45	520	26000	55	45	KM9	680
TL-KL12-42 x 55	42 x 55	70	30	46	680	30000	60	50	KM10	870
TL-KL12-45 x 55	45 x 55	70	30	46	680	30000	60	50	KM10	870
TL-KL12-48 x 60	48 x 60	75	30	46	840	35000	60	50	KM11	970
TL-KL12-50 x 60	50 x 60	75	30	46	880	35000	60	50	KM11	970
TL-KL12-55 x 65	55 x 65	80	30	46	1030	37000	60	50	KM12	1100
TL-KL12-60 x 70	60 x 70	85	30	52	1360	45000	65	55	KM13	1300

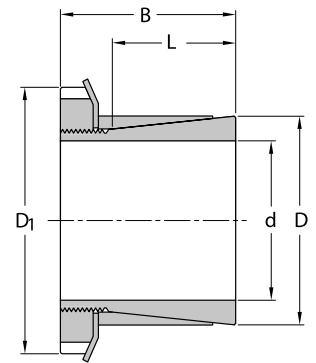

SERIES TL-LOCK13

Available for shaft diameters from 6 to 50 mm. Medium-high torque. Few clamping screws.

REFERENCE	DIMENSIONS			TORQUE Mt	PRESSURE		CLAMPING BOLTS DIN912-12.9		
	d x D mm	L1 mm	B mm		Pw	Pn	Qty	Size	Ms
TL-KL13-10 x 20	10 x 20	13	15,50	15	110	55	4	M2.5	1,2
TL-KL13-12 x 22	12 x 22	13	15,50	20	90	50	4	M2.5	1,2
TL-KL13-14 x 26	14 x 26	17	20,00	35	105	55	4	M3	2,1
TL-KL13-15 x 28	15 x 28	17	20,00	40	100	50	4	M3	2,1
TL-KL13-16 x 32	16 x 32	17	21,00	70	130	65	4	M4	4,9
TL-KL13-18 x 35	18 x 35	21	25,00	80	115	60	4	M4	4,9
TL-KL13-19 x 35	19 x 35	21	25,00	85	110	60	4	M4	4,9
TL-KL13-20 x 38	20 x 38	21	26,00	220	220	115	6	M5	10
TL-KL13-22 x 40	22 x 40	21	26,00	240	200	110	6	M5	10
TL-KL13-24 x 47	24 x 47	26	32,00	380	220	110	6	M6	17
TL-KL13-25 x 47	25 x 47	26	32,00	390	210	110	6	M6	17

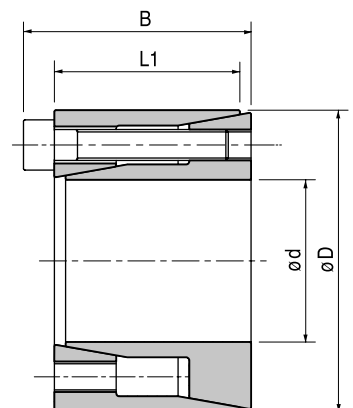

SERIES TL-LOCK14

Available for shafts diameters from 45 to 400 mm.
Suitable for very high torques. Withstand bending moments.

Even pressure distribution. No axial displacement.

REFERENCE	DIMENSIONS				TORQUE Mt	THRUST Ft	PRESSURE		CLAMPING BOLTS DIN912-12.9		
	d x D mm	L1 mm	L2 mm	B mm			Pw	Pn	Qty	Size	Ms
TL-KL14-45 x 75	45 x 75	56	64	72	3460	155000	165	100	8	M8	41
TL-KL14-48 x 80	48 x 80	56	64	72	3680	155000	150	95	8	M8	41
TL-KL14-50 x 80	50 x 80	56	64	72	3820	155000	147	95	8	M8	41
TL-KL14-55 x 85	55 x 85	56	64	72	4260	155000	135	85	8	M8	41
TL-KL14-60 x 90	60 x 90	56	64	72	5820	190000	155	100	10	M8	41
TL-KL14-65 x 95	65 x 95	56	64	72	6270	190000	140	95	10	M8	41
TL-KL14-70 x 110	70 x 110	70	78	88	10730	305000	170	105	10	M10	83
TL-KL14-75 x 115	75 x 115	70	78	88	11540	305000	155	100	10	M10	83
TL-KL14-80 x 120	80 x 120	70	78	88	14700	369000	175	115	12	M10	83
TL-KL14-85 x 125	85 x 125	70	78	88	15700	369000	165	110	12	M10	83
TL-KL14-90 x 130	90 x 130	70	78	88	16610	370000	157	106	12	M10	83
TL-KL14-95 x 135	95 x 135	70	78	88	17530	370000	150	102	12	M10	83
TL-KL14-100 x 145	100 x 145	90	100	112	26900	538000	160	110	12	M12	145
TL-KL14-110 x 155	110 x 155	90	100	112	29530	538000	143	102	12	M12	145
TL-KL14-120 x 165	120 x 165	90	100	112	37610	628000	154	112	14	M12	145
TL-KL14-130 x 180	130 x 180	104	116	130	48000	738000	143	106	12	M14	230
TL-KL14-140 x 190	140 x 190	104	116	130	60290	861000	160	117	14	M14	230
TL-KL14-150 x 200	150 x 200	104	116	130	73800	985000	165	125	16	M14	230
TL-KL14-160 x 210	160 x 210	104	116	130	78770	983000	155	118	16	M14	230
TL-KL14-170 x 225	170 x 225	134	146	162	101730	1197000	140	108	14	M16	355
TL-KL14-180 x 235	180 x 235	134	146	162	123200	1369000	150	115	16	M16	355
TL-KL14-190 x 250	190 x 250	134	146	162	129880	1368000	141	110	16	M16	355
TL-KL14-200 x 260	200 x 260	134	146	162	136840	1368000	137	104	16	M16	355
TL-KL14-220 x 285	220 x 285	134	146	162	188000	1710000	155	120	20	M16	355
TL-KL14-240 x 305	240 x 305	134	146	162	225000	1880000	155	120	22	M16	355
TL-KL14-260 x 325	260 x 325	134	146	162	244000	1880000	155	115	22	M16	355
TL-KL14-280 x 355	280 x 355	165	177	197	373000	2670000	145	120	20	M20	690
TL-KL14-300 x 375	300 x 375	165	177	197	440000	2930000	155	25	22	M20	690
TL-KL14-320 x 405	320 x 405	165	177	197	470000	2930000	145	115	22	M20	690
TL-KL14-340 x 425	340 x 425	165	177	197	544000	3200000	150	120	24	M20	690
TL-KL14-360 x 455	360 x 455	190	202	224	658000	3650000	140	110	22	M22	930
TL-KL14-380 x 475	380 x 475	190	202	224	821000	4320000	160	130	26	M22	930
TL-KL14-400 x 495	400 x 495	190	202	224	864000	4320000	150	120	26	M22	930

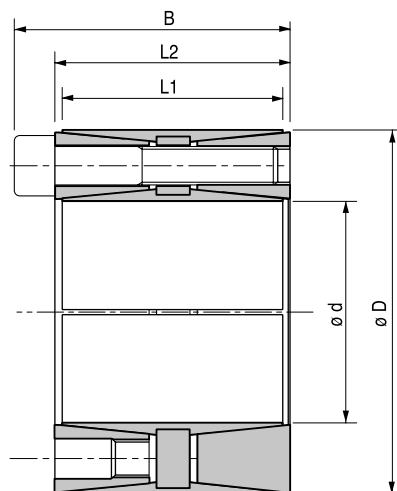

SERIES TL-LOCK15

Available for shafts diameters from 25 to 400.
Suitable for very high torques and withstand bending moments.

REFERENCE	DIMENSIONS				TORQUE Mt	THRUST Ft	PRESSURE		CLAMPING BOLTS DIN912-12.9		
	d x D mm	L1 mm	L2 mm	B mm			Pw	Pn	Qty	Size	Ms
TL-KL15-25 x 50	25 x 50	39	45	51	950	76000	245	122	6	M6	17
TL-KL15-28 x 55	28 x 55	39	45	51	1070	76000	245	122	6	M7	18
TL-KL15-30 x 55	30 x 55	39	45	51	1150	76000	245	122	6	M8	19
TL-KL15-35 x 60	35 x 60	39	45	51	1340	76000	245	122	6	M9	20
TL-KL15-38 x 65	38 x 65	39	45	51	1450	76000	161	94	8	M6	17
TL-KL15-40 x 65	40 x 65	39	64	51	1530	76000	153	94	8	M6	17
TL-KL15-42 x 75	42 x 75	56	64	72	2970	141000	188	105	8	M8	41
TL-KL15-45 x 75	45 x 75	56	64	72	3150	141000	175	105	8	M8	41
TL-KL15-48 x 80	48 x 80	56	64	72	4000	166000	164	98	8	M8	41
TL-KL15-50 x 80	50 x 80	56	64	72	4150	166000	158	98	8	M8	41
TL-KL15-55 x 85	55 x 85	56	64	72	4550	166000	143	93	8	M8	41
TL-KL15-60 x 90	60 x 90	56	64	72	6200	166000	164	109	10	M8	41
TL-KL15-65 x 95	65 x 95	56	64	72	6750	207000	152	104	10	M8	41
TL-KL15-70 x 110	70 x 110	70	78	88	11550	330000	179	114	10	M10	83
TL-KL15-75 x 115	75 x 115	70	78	88	12350	330000	167	109	10	M10	83
TL-KL15-80 x 120	80 x 120	70	78	88	15800	396000	188	125	12	M10	83
TL-KL15-85 x 125	85 x 125	70	78	88	16800	396000	177	120	12	M10	83
TL-KL15-90 x 130	90 x 130	70	78	88	17800	396000	167	115	12	M10	83
TL-KL15-95 x 135	95 x 135	70	78	88	18800	396000	158	111	12	M10	83
TL-KL15-100 x 145	100 x 145	90	100	112	28800	576000	170	117	12	M12	145
TL-KL15-110 x 155	110 x 155	90	100	112	31700	576000	155	110	12	M12	145
TL-KL15-120 x 165	120 x 165	90	100	112	40300	573000	165	120	14	M12	145
TL-KL15-130 x 180	130 x 180	104	116	130	51400	791000	155	112	12	M14	230
TL-KL15-140 x 190	140 x 190	104	116	130	64600	923000	168	124	14	M14	230
TL-KL15-150 x 200	150 x 200	104	116	130	79100	1055000	179	135	16	M14	230
TL-KL15-160 x 210	160 x 210	104	116	130	84400	1055000	168	128	16	M14	230
TL-KL15-170 x 225	170 x 225	134	146	162	109000	1283000	149	113	14	M16	355
TL-KL15-180 x 235	180 x 235	134	146	162	132000	1466000	161	124	16	M16	355
TL-KL15-190 x 250	190 x 250	134	146	162	139000	1466000	153	116	16	M16	355
TL-KL15-200 x 260	200 x 260	134	146	162	146500	1466000	145	112	16	M16	355
TL-KL15-220 x 285	220 x 285	134	146	162	201500	1833000	165	127	20	M16	355
TL-KL15-240 x 305	240 x 305	134	146	162	242000	2017000	166	131	22	M16	355
TL-KL15-260 x 325	260 x 325	134	146	162	262000	2017000	154	123	22	M16	355
TL-KL15-280 x 355	280 x 355	165	177	197	400000	2862000	164	130	20	M20	690
TL-KL15-300 x 375	300 x 375	165	177	197	472000	3148000	169	135	22	M20	690
TL-KL15-320 x 405	320 x 405	165	177	197	503500	3148000	158	125	22	M20	690
TL-KL15-340 x 425	340 x 425	165	177	197	583500	3434000	162	130	24	M20	690
TL-KL15-360 x 455	360 x 455	190	202	224	705000	3918000	152	120	22	M22	930
TL-KL15-380 x 475	380 x 475	190	202	224	880000	4631000	170	136	26	M22	930
TL-KL15-400 x 495	400 x 495	190	202	224	926000	4631000	162	131	26	M22	930

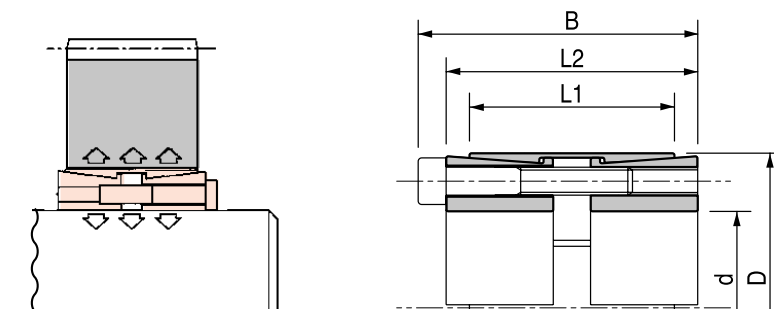

SERIES TL-LOCK16

Available for shaft diameters from 12 to 480 mm.
Medium – high torques. No axial displacement.

Easy and fast mounting and dismounting.

REFERENCE	DIMENSIONS							TORQUE	THRUST	CLAMPING BOLTS DIN912-12.9		
	d mm	dw mm	D mm	L1	L	d1 mm	e mm			Mt	Fr	Qty
TL-KL16-14-11	14	11	38	7	11	23	2,00	30	6000	4	M5	4
TL-KL16-14-12		12				23	2,00	50	9000			
TL-KL16-16-13	16	13	41	11	15	26	2,00	70	10000	5	M5	4
TL-KL16-16-14		14				26	2,00	90	13000			
TL-KL16-24-19	24	19	50	14	19,5	36	2,75	170	25000	6	M5	4
TL-KL16-24-20		20				36	2,75	210	27000			
TL-KL16-24-21		21				36	2,75	250	29000			
TL-KL16-30-24	21	24	60	16	21,5	44	2,75	300	29000	7	M5	4
TL-KL16-30-25		25				44	2,75	340	31000			
TL-KL16-30-26		26				44	2,75	380	33000			
TL-KL16-36-28	36	28	72	18	23,5	52	2,75	440	50000	5	M6	12
TL-KL16-36-30		30				52	2,75	570	58000			
TL-KL16-36-31		31				52	2,75	630	58000			
TL-KL16-44-32	44	32	80	20	25,5	61	2,75	620	64000	7	M6	12
TL-KL16-44-35		35				61	2,75	780	74000			
TL-KL16-44-36		36				61	2,75	860	77000			
TL-KL16-50-38	50	38	90	22	27,5	70	2,75	940	79000	8	M6	12
TL-KL16-50-40		40				70	2,75	1160	86000			
TL-KL16-50-42		42				70	2,75	1380	92000			
TL-KL16-55-42	55	42	100	23	30,5	75	3,75	1160	79000	8	M6	12
TL-KL16-55-45		45				75	3,75	1520	88000			
TL-KL16-55-48		48				75	3,75	1880	97000			
TL-KL16-62-48	62	48	110	23	30,5	86	3,75	1850	100000	10	M6	12
TL-KL16-62-50		50				86	3,75	2200	111000			
TL-KL16-62-52		52				86	3,75	2400	117000			
TL-KL16-68-50	68	50	115	23	30,5	86	3,75	2000	97000	10	M6	12
TL-KL16-68-55		55				86	3,75	2500	106000			
TL-KL16-68-60		60				86	3,75	3150	120000			
TL-KL16-75-55	75	55	138	25	32,5	100	3,75	2500	119000	7	M8	30
TL-KL16-75-60		60				100	3,75	3200	137000			
TL-KL16-75-65		65				100	3,75	3950	155000			
TL-KL16-80-60	80	60	145	25	32,5	100	3,75	3200	124000	7	M8	30
TL-KL16-80-65		65				100	3,75	3900	140000			
TL-KL16-80-70		70				100	3,75	4600	158000			
TL-KL16-85-65	85	65	155	30	39	114	4,50	4800	175000	10	M8	30
TL-KL16-85-70		70				114	4,50	6100	195000			
TL-KL16-85-75		75				114	4,50	7400	216000			
TL-KL16-90-65	90	65	155	30	39	114	4,50	4750	170000	10	M8	30
TL-KL16-90-70		70				114	4,50	6000	190000			
TL-KL16-90-75		75				114	4,50	7250	210000			
TL-KL16-100-70	100	70	170	34	44	124	5,00	6900	195000	12	M8	30
TL-KL16-100-75		75				124	5,00	7500	220000			
TL-KL16-100-80		80				124	5,00	9000	240000			
TL-KL16-110-75	110	75	185	39	50	136	5,50	7200	229000	9	M10	59
TL-KL16-110-80		80				136	5,50	9000	252000			
TL-KL16-110-85		85				136	5,50	10800	262000			
TL-KL16-115-80	115	80	188	39	50	141	5,50	7400	235000	9	M10	59
TL-KL16-115-85		85				141	5,50	9200	259000			
TL-KL16-115-90		90				141	5,50	11100	269000			
TL-KL16-120-80	120	80	215	42	54	160	6,00	10600	285000	12	M10	59
TL-KL16-120-85		85				160	6,00	13300	314000			
TL-KL16-120-90		90				160	6,00	14500	340000			

NEXT >



SERIES TL-LOCK16

Available for shaft diameters from 12 to 480 mm.
Medium – high torques. No axial displacement.

Easy and fast mounting and dismounting.

REFERENCE	DIMENSIONS							TORQUE Mt	THRUST Fr	CLAMPING BOLTS DIN912-12.9		
	d mm	dw mm	D mm	L1	L	d1 mm	e mm			Qty	Size	Ms
TL-KL16-125-85		85				160	6,00	11000	296000			
TL-KL16-125-90	125	90	215	42	54	160	6,00	13000	324000	12	M10	59
TL-KL16-125-95		95				160	6,00	15000	352000			
TL-KL16-130-90		90				160	6,00	11300	304000			
TL-KL16-130-95	130	95	215	42	54	160	6,00	13300	333000	12	M10	59
TL-KL16-130-100		100				160	6,00	15400	362000			
TL-KL16-140-95		95				175	7,25	15100	367000			
TL-KL16-140-100	140	100	230	46	60,5	175	7,25	17600	396000	10	M12	100
TL-KL16-140-105		105				175	7,25	20100	425000			
TL-KL16-155-105		105				192	7,25	22000	447000			
TL-KL16-155-110	155	110	265	50	64,5	192	7,25	25000	478000	12	M12	100
TL-KL16-155-115		115				192	7,25	28000	509000			
TL-KL16-160-110		110				192	7,25	22600	460000			
TL-KL16-160-115	160	115	265	50	64,5	192	7,25	25700	490000	12	M12	100
TL-KL16-160-120		120				192	7,25	28800	520000			
TL-KL16-165-115		115				210	7,50	31000	595000			
TL-KL16-165-120	165	120	290	56	71	210	7,50	35000	630000	8	M16	250
TL-KL16-165-125		125				210	7,50	39000	655000			
TL-KL16-170-120		120				210	7,50	31900	610000			
TL-KL16-170-125	170	125	290	56	71	210	7,50	36000	640000	8	M16	250
TL-KL16-170-130		130				210	7,50	40100	670000			
TL-KL16-175-125		125				220	7,50	36000	605000			
TL-KL16-175-130	175	130	300	56	71	220	7,50	41000	639000	8	M16	250
TL-KL16-175-135		135				220	7,50	45000	675000			
TL-KL16-180-130		130				220	7,50	37000	800000			
TL-KL16-180-135	180	135	300	56	71	220	7,50	42200	840000	8	M16	250
TL-KL16-180-140		140				220	7,50	46300	885000			
TL-KL16-185-135		135				236	7,50	52000	778000			
TL-KL16-185-140	185	140	330	71	86	236	7,50	57000	819000	10	M16	250
TL-KL16-185-145		145				236	7,50	62000	861000			
TL-KL16-190-140		140				236	7,50	63500	800000			
TL-KL16-190-145	190	145	330	71	86	236	7,50	58700	840000	10	M16	250
TL-KL16-190-150		150				236	7,50	63800	885000			
TL-KL16-195-140		140				246	7,50	65000	933000			
TL-KL16-195-150	195	150	350	71	86	246	7,50	76000	1025000	12	M16	250
TL-KL16-195-155		155				246	7,50	81500	1071000			
TL-KL16-200-150		150				246	7,50	74000	990000			
TL-KL16-200-155	200	155	350	71	86	246	7,50	80000	1035000	12	M16	250
TL-KL16-200-160		160				246	7,50	86000	1080000			
TL-KL16-220-160		160				270	8,00	95000	1190000			
TL-KL16-220-165	220	165	370	88	104	270	8,00	102000	1239000	15	M16	250
TL-KL16-220-170		170				270	8,00	110000	1290000			
TL-KL16-240-170		170				295	8,50	120000	1464000			
TL-KL16-240-180	240	180	405	92	109	295	8,50	138000	1576000	12	M20	490
TL-KL16-240-190		190				295	8,50	156000	1675000			
TL-KL16-260-190		190				321	8,50	164000	1760000			
TL-KL16-260-200	260	200	430	103	120	321	8,50	184000	1880000	14	M20	490
TL-KL16-260-210		210				321	8,50	205000	2010000			
TL-KL16-280-210		210				346	10,00	217000	2090000			
TL-KL16-280-220	280	220	460	114	134	346	10,00	244000	2220000	16	M20	490
TL-KL16-280-230		230				346	10,00	270000	2350000			

REFERENCE	DIMENSIONS							TORQUE	THRUST	CLAMPING BOLTS DIN912-12.9		
	d mm	dw mm	D mm	L1	L	d1 mm	e mm	Mt	Ft	Qty	Size	Ms
TL-KL16-300-230		230				364	10,00	275000	2431000			
TL-KL16-300-240	300	240	485	122	142	364	10,00	295000	2567000	18	M20	490
TL-KL16-300-245		245				364	10,00	315000	2636000			
TL-KL16-320-240		240				386	10,00	312000	2647000			
TL-KL16-320-250	320	250	520	122	142	386	10,00	340000	2786000	20	M20	490
TL-KL16-320-260		260				386	10,00	374000	2900000			
TL-KL16-340-250	340	250	570	134	156	408	11,00	390000	3119000	24	M20	490
TL-KL16-340-260		260				408	11,00	422500	3249000			
TL-KL16-340-270	340	270	570	134	156	408	11,00	460000	3400000	24	M20	490
TL-KL16-350-270		270				432	11,00	442000	3276000			
TL-KL16-350-280	350	280	580	140	162	432	11,00	480000	3430000	24	M20	490
TL-KL16-350-285		285				432	11,00	500000	3500000			
TL-KL16-360-280		280				432	11,00	463000	3310000			
TL-KL16-360-290	360	290	590	140	162	432	11,00	502000	3461000	24	M20	490
TL-KL16-360-295		295				432	11,00	522000	3536000			
TL-KL16-380-290		290				458	12,00	567000	3910000			
TL-KL16-380-300	380	300	645	144	168	458	12,00	610000	4080000	20	M24	840
TL-KL16-380-310		310				458	12,00	658000	4248000			
TL-KL16-390-300		300				468	12,00	624000	4160000			
TL-KL16-390-310	390	310	660	144	168	468	12,00	671000	4330000	21	M24	840
TL-KL16-390-320		320				468	12,00	718000	4484000			
TL-KL16-400-315		315				480	12,00	670000	4260000			
TL-KL16-400-320	400	320	680	144	168	480	12,00	695000	4345000	21	M24	840
TL-KL16-400-330		330				480	12,00	744000	4500000			
TL-KL16-420-330		330				504	12,00	780000	4850000			
TL-KL16-420-340	420	340	690	164	188	504	12,00	840000	5040000	21	M24	840
TL-KL16-420-350		350				504	12,00	900000	5220000			
TL-KL16-440-340		340				527	12,50	806000	4740000			
TL-KL16-440-350	440	350	750	177	202	527	12,50	860000	4910000	24	M24	840
TL-KL16-440-360		360				527	12,50	917000	5090000			
TL-KL16-460-360		360				527	12,50	1000000	5670000			
TL-KL16-460-370	460	370	770	177	202	527	12,50	1070000	5860000	28	M24	840
TL-KL16-460-380		380				527	12,50	1114000	6050000			
TL-KL16-480-380		380				570	12,50	1170000	6150000			
TL-KL16-480-390	480	390	800	188	213	570	12,50	1240000	6350000	30	M24	840
TL-KL16-480-400		400				570	12,50	1310000	6550000			

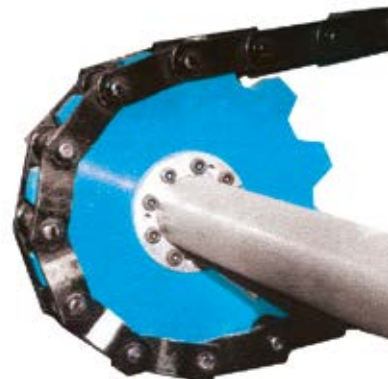
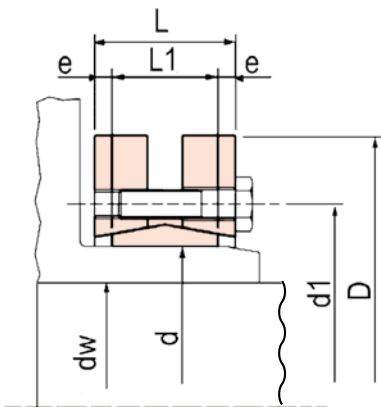

Application on a conveyor chain-sprocket

SERIES TL-LOCK17

Suitable for heavy duty conditions. Very high torques.

REFERENCE	DIMENSIONS				TORQUE	PRESSURE		CLAMPING BOLTS DIN912-12.9		
	d x D mm	L1 mm	L2 mm	L mm	Mt	Pw	Pn	Qty	Size	Ms
TL-KL17-25 x 55	25 x 55	32	40	46	840	295	134	6	M6	17
TL-KL17-28 x 55	28 x 55	32	40	46	940	264	134	6	M6	17
TL-KL17-30 x 55	30 x 55	32	40	46	1000	246	134	6	M6	17
TL-KL17-36 x 60	36 x 60	44	54	60	1360	174	101	7	M6	17
TL-KL17-38 x 75	38 x 75	44	54	62	2740	296	150	7	M8	41
TL-KL17-40 x 75	40 x 75	44	54	62	2880	281	150	7	M8	41
TL-KL17-42 x 75	42 x 75	44	54	62	3030	268	150	7	M8	41
TL-KL17-45 x 75	45 x 75	44	54	62	3240	250	150	7	M8	41
TL-KL17-48 x 80	48 x 80	56	64	72	3950	207	124	8	M8	41
TL-KL17-50 x 80	50 x 80	56	64	72	4150	200	98	8	M8	41
TL-KL17-55 x 85	55 x 85	56	64	72	5150	205	104	9	M8	41
TL-KL17-60 x 90	60 x 90	56	64	72	6200	202	106	10	M8	41
TL-KL17-65 x 95	65 x 95	56	64	72	6750	187	100	10	M8	41
TL-KL17-70 x 110	70 x 110	70	78	88	11500	223	114	10	M10	83
TL-KL17-75 x 115	75 x 115	70	78	88	12300	223	114	10	M10	83
TL-KL17-80 x 120	80 x 120	70	78	88	14500	215	115	11	M10	83
TL-KL17-85 x 125	85 x 125	70	78	88	15400	215	115	12	M10	83
TL-KL17-90 x 130	90 x 130	70	78	88	17800	208	115	12	M10	83
TL-KL17-95 x 135	95 x 135	70	78	88	18700	208	115	12	M10	83
TL-KL17-100 x 145	100 x 145	90	100	112	26300	200	107	11	M12	145
TL-KL17-110 x 155	110 x 155	90	100	112	31800	198	110	12	M12	145
TL-KL17-120 x 165	120 x 165	90	100	112	40400	212	120	14	M12	145
TL-KL17-130 x 180	130 x 180	104	116	130	51500	192	112	12	M14	230
TL-KL17-140 x 190	140 x 190	104	116	130	64700	208	124	14	M14	230
TL-KL17-150 x 200	150 x 200	104	116	130	74200	208	127	15	M14	230
TL-KL17-160 x 210	160 x 210	104	116	130	84500	208	128	16	M14	230
TL-KL17-170 x 225	170 x 225	134	148	164	108200	182	113	14	M16	355
TL-KL17-180 x 235	180 x 235	134	148	164	123250	184	115	15	M16	355
TL-KL17-190 x 250	190 x 250	134	148	164	133800	186	116	16	M16	355
TL-KL17-200 x 260	200 x 260	134	148	164	146000	177	112	16	M16	355
TL-KL17-220 x 285	220 x 285	134	148	164	181000	188	115	18	M16	355
TL-KL17-240 x 305	240 x 305	134	148	164	218000	184	119	2	M16	355
TL-KL17-260 x 325	260 x 325	134	148	164	250000	178	117	21	M16	355
TL-KL17-280 x 355	280 x 355	165	177	197	360000	185	117	18	M20	690
TL-KL17-300 x 375	300 x 375	165	177	197	428000	192	123	20	M20	690

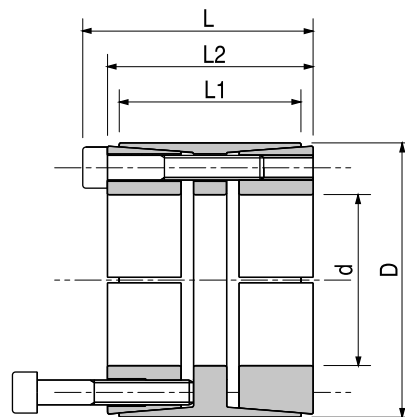
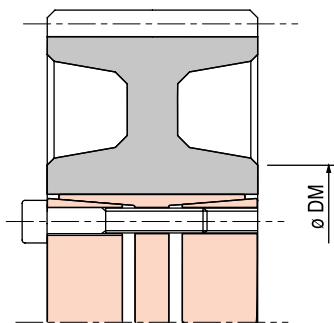

SERIES TL-LOCK18

Suitable for medium to high torques.

REFERENCE	DIMENSIONS					TORQUE Mt	THRUST Ft	PRESSURE		CLAMPING BOLTS DIN912-12.9		
	d x D mm	L1 mm	L2 mm	L3 mm	L mm			Pw	Pn	Qty	Size	Ms
TL-KL18-20 x 47	20 x 47	10	14	28	34	245	29400	210	93	5	M6	17
TL-KL18-22 x 47	22 x 47	10	14	28	34	265	30000	196	93	5	M6	17
TL-KL18-24 x 50	24 x 50	10	14	28	34	370	32300	215	108	6	M6	17
TL-KL18-25 x 50	25 x 50	10	14	28	34	390	33300	210	108	6	M6	17
TL-KL18-30 x 55	30 x 55	10	14	28	34	480	41200	186	98	6	M6	17
TL-KL18-35 x 60	35 x 60	10	14	28	34	735	44100	186	108	8	M6	17
TL-KL18-38 x 65	38 x 65	10	14	28	34	790	46100	206	103	8	M6	17
TL-KL18-40 x 65	40 x 65	10	14	28	34	830	47000	186	103	8	M6	17
TL-KL18-42 x 75	42 x 75	12	18	35	43	1450	66000	225	132	7	M8	41
TL-KL18-45 x 75	45 x 75	12	18	35	43	1560	70000	220	132	7	M8	41
TL-KL18-50 x 80	50 x 80	12	18	35	43	1650	72000	206	127	7	M8	41
TL-KL18-55 x 85	55 x 85	12	18	35	43	2250	80000	210	132	8	M8	41
TL-KL18-60 x 90	60 x 90	12	18	35	43	2450	83000	186	122	8	M8	41
TL-KL18-65 x 95	65 x 95	12	18	35	43	2890	90000	200	132	9	M8	41
TL-KL18-70 x 110	70 x 110	16	24	46	56	4700	130000	220	140	8	M10	83

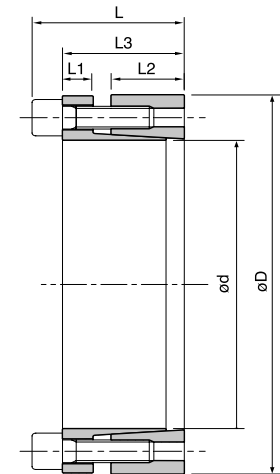
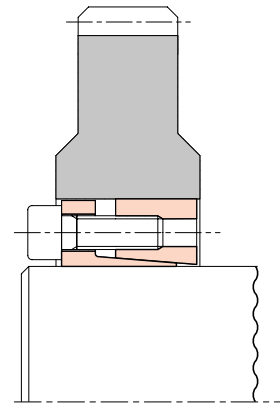

SERIES TL-LOCK19

Easy and fast mounting and dismounting. Not self centering.
Suitable for medium torques.

REFERENCE	DIMENSIONS				TORQUE Mt	PRESSURE		CLAMPING BOLTS DIN912-12.9		
	d x D mm	L1 mm	L2 mm	L mm		Pw	Pn	Qty	Size	Ms
TL-KL19-18 x 40	18 x 40	12	18,50	24,50	190	260	120	6	M6	16
TL-KL19-19 x 41	19 x 41	12	18,50	24,50	210	260	120	6	M6	16
TL-KL19-20 x 42	20 x 42	12	18,50	24,50	240	2500	120	6	M6	16
TL-KL19-24 x 46	24 x 46	12	18,50	24,50	290	250	120	6	M6	16
TL-KL19-25 x 47	25 x 47	12	18,50	24,50	330	230	120	8	M6	16
TL-KL19-28 x 50	28 x 50	12	18,50	24,50	370	220	120	8	M6	16
TL-KL19-30 x 52	30 x 52	12	18,50	24,50	430	210	120	8	M6	16
TL-KL19-35 x 57	35 x 57	15	28,00	28,00	610	170	100	12	M6	16
TL-KL19-38 x 60	38 x 60	15	28,00	28,00	680	170	100	12	M6	16
TL-KL19-40 x 62	40 x 62	15	28,00	28,00	780	170	10	12	M6	16
TL-KL19-42 x 70	42 x 70	18	36,00	36,00	1480	190	110	12	M8	41
TL-KL19-45 x 73	45 x 73	18	36,00	36,00	1500	210	130	12	M8	41
TL-KL19-48 x 76	48 x 76	18	36,00	36,00	1550	210	130	12	M8	41
TL-KL19-50 x 78	50 x 78	18	36,00	36,00	1650	190	120	12	M8	41
TL-KL19-55 x 83	55 x 83	18	36,00	36,00	2000	190	120	16	M8	41
TL-KL19-60 x 88	60 x 88	18	36,00	36,00	2350	190	120	16	M8	41
TL-KL19-70 x 105	70 x 105	22	45,00	45,00	3900	180	120	12	M10	70
TL-KL19-80 x 115	80 x 115	22	45,00	45,00	4800	170	120	16	M10	70

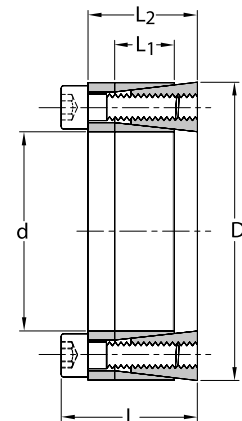

Directions to Assembly and Disassembly

The working principle of these units is based on friction, thus consequently the use of grease or high pressure additives will reduce the

coefficient factor.

The use of impact wrenches is not advisable.

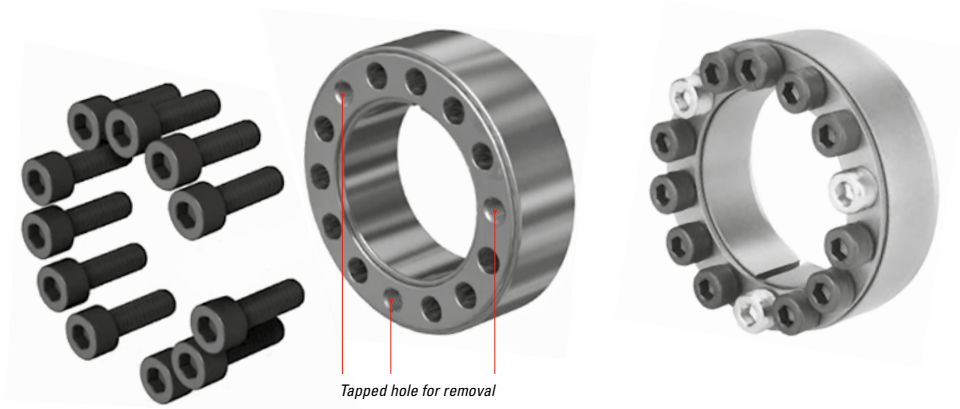

To assemble:

- Clean the contact surfaces of the shaft and unit and splash a thin layer of oil.
- Push the device in place either internal or external onto the shaft.
- Tighten the bolts to halfway of the tightening torque. (Do not use impact drivers nor impact wrenches a Dynamometric Torque wrench instead) in a star-like sequence.
- Retighten the bolts to the Torque value Ms indicated in the particular table.

To disassemble:

- Check that there is not live torque or load.
- Remove the bolts halfway in a star-like sequence. Care must be taken as the shaft may spin.
- In case that the wedge ring does not remove, introduce the bolts into the removal tapped holes as marked in the picture and tight them until loosening the grip.

GUIDE TO ORDER

Example:

TL-KL-3-18 x 26

Stands for a KL locking device, Model 3, Diameter d 18 mm, Diameter D 26 mm

