



Timing pulleys



BASICS ON TIMING PULLEYS

Timing Pulleys together with Timing Belts make up the Timing Belt Drives. The teeth of the Timing Belt mesh with the hollows between teeth of the pulley and by gear action between the belt and the pulley, transfer the power and torque.

The Timing Belt drives, usually referred to Synchronous Belt drives, perform as well as gears and chains with additional advantages as.

There is no any backlash due to the absence of slippage, high power and torque transmission at low speeds, noiseless running operation, smooth and regular motion as there is no chordal effect, minor assembly pretension as no adherence between belt and pulley is needed, cheap maintenance, broad range of speeds, high efficiency, simultaneous power transfer to different shafts, low space need due to small construction mass and minor load transfer to bearings.

Timing Pulleys consist of a rim, a hub and a plate or spoke to join the hub with the rim, whereas the rim is toothed. The profiles of the teeth may vary according standards. The first known is the trapezoidal profile with rectilinear flanks which generate an involute¹, well defined in the ISO 5294 Standard. Subsequently there are other profile shapes, basically curvilinear which produce a better transition of the belt than those of the trapezoidal shape while practically eliminating the backlash, an essential property to a synchronous drive.

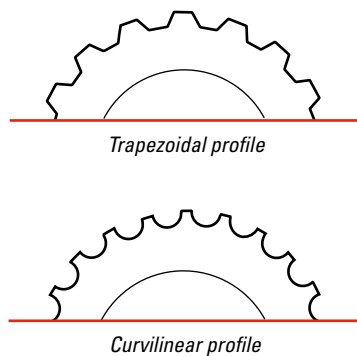

The choice of one profile shape or another will vary according the application. While the Trapezoidal Profile with a certain backlash may be used in low motion systems, the Curvilinear shape is more suited for high speed, high torque and where the backlash has to be brought to a minimum.

The Timing Pulleys features are described in the Standards as follows.

ISO 5288. Specifies the terms and definitions related to synchronous belt drives for mechanical power transmission.

ISO 5294. Specifies the characteristics of synchronous endless belt drives for mechanical power transmission, namely the pulley dimensions and tolerances, the tooth dimensions and tolerances and quality specifications. Timing Pulleys under this Standard for pitch code is interchangeable with ISO5296.

ISO 13050. Curvilinear toothed synchronous belt drive systems

DIN 7721. Describes the synchronous belt drives, metric pitch; tooth space profile of synchronous pulleys.

Common terminology of Timing Pulleys includes, although is not limited to.

Pitch of the Timing Belt. The distance between two adjacent tooth centers measured on the pitch line

Pitch of the Timing belt Pulley. The arch distance between two adjacent centers measured on the Timing belt line.

Pitch Circle: The circle described by the timing belt pulley pitch coinciding with the timing belt pitch line.

Pitch diameter: Timing belt pulley pitch is always greater than its outside diameter.

Parallel misalignment: Occurs when the driver and driven timing pulleys are in a different plane.

Angular misalignment: Occurs when the driving and driven shafts are not parallel, with the result of uneven loading of the tensile cords producing edge wear.

Run Out: The measure variation of the perpendicular distance from the shaft to the pulley's flat top.

Backlash: The clearance between the timing belt teeth and the mating timing belt groove. A certain clearance is needed in timing belt drives to allow the timing belt teeth enter and leave the grooves with the minimal interference.

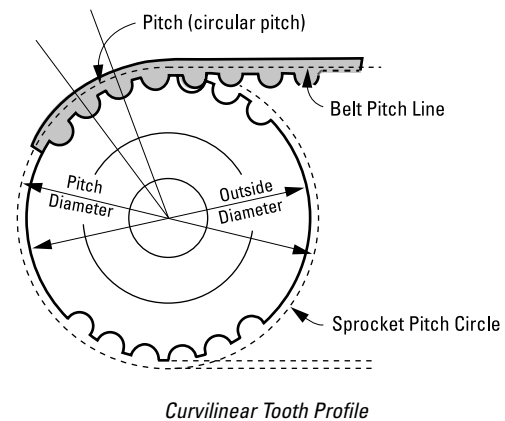

Ratcheting: Occurs when the belt drive has a low tension provoking the belt pitch mismatch with the pulley groove pitch.

Timing Belts due to the construction in spiral, although minimized combining S and Z twists of the cords, have a tendency to move to one side of the Timing Pulley. This side travel can be modified by adjusting the tension while to prevent the belt ratcheting, flanges can be mounted at the end of Timing Pulleys.

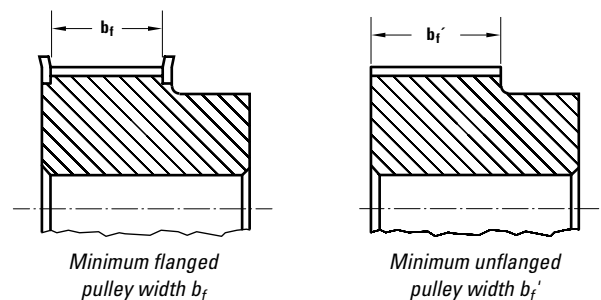

¹ Involute: Curved inward or spirally. The involute pulley profile has the effect of uniform angular motion to the mating belt.

TIMING PULLEYS ANSI / ARPM / RMA / MPTA IP-24 STANDARD

The Standard specifies the principal characteristics of synchronous endless belt drives for mechanical power transmission and where positive indexing or synchronization may be required. The quality, finish and balance of transmission pulleys is specified in the ISO 254.

Pulley width: The pulley width designation, the nominal pulley width, and the minimum actual pulley width required b_f for flanged pulleys, b_f' for unflanged pulleys.

ARPM / RMA / MPTA IP-24. Specifications for Drives Using Synchronous Belts. (MXL, XL, L, H, XH and XXH)

PITCH CODE	MINIMUM FLANGE HEIGHT h	
	mm	in
MXL	0,50	0,02
XXL	0,80	0,03
XL	1,00	0,04
L	1,50	0,06
H	2,00	0,08
XH	4,80	0,19
XXH	6,10	0,24

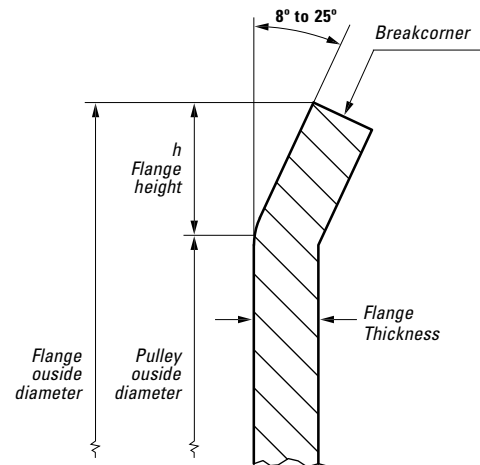

PITCH CODE	PULLEY WIDTH WIDTH CODE	NOMINAL PULLEY WIDTH		MINIMUM FLANGED PULLEY WIDTH b_f		MINIMUM UNFLANGED PULLEY WIDTH b_f'	
		mm	in	mm	in	mm	in
MXL	012	3,20	0,12	3,80	0,15	5,60	0,22
	019	4,80	0,18	5,30	0,21	7,10	0,28
	025	6,40	0,25	7,10	0,28	8,90	0,35
XXL	012	3,20	0,12	3,80	0,15	5,60	0,22
	019	4,80	0,18	5,30	0,21	7,10	0,28
	025	6,40	0,25	7,10	0,28	8,90	0,35
XL	025	6,40	0,25	7,10	0,28	8,90	0,35
	031	7,90	0,31	8,60	0,34	10,40	0,41
	037	9,50	0,37	10,40	0,41	12,20	0,48
L	050	12,70	0,50	14,00	0,55	17,00	0,67
	075	19,10	0,75	20,30	0,80	23,30	0,92
	100	25,40	1,00	26,70	1,05	29,70	1,17
H	075	19,10	0,75	20,30	0,80	24,80	0,98
	100	25,40	1,00	26,70	1,05	31,20	1,23
	150	38,1	1,50	39,40	1,55	43,90	1,73
XH	200	50,80	2,00	52,80	2,08	57,30	2,26
	300	76,20	3,00	79,00	3,11	83,50	3,29
	200	50,80	2,00	56,60	2,23	62,60	2,46
XXH	300	76,20	3,00	83,80	3,30	89,80	3,54
	400	101,60	4,00	110,70	4,36	116,70	4,59
	200	50,80	2,00	56,60	2,23	84,10	2,52
XXH	300	76,20	3,00	83,80	3,30	91,30	3,59
	400	101,60	4,00	110,70	4,36	118,20	4,65
	500	127,00	5,00	137,70	5,42	145,20	5,72

The Standard establishes the tolerances of circular run-out, radial run-out, parallelism, and taper.

CLASSICAL TIMING PULLEYS. PROFILES XL, L, H, XH. RSB

BELT PROFILE	BELT WIDTH	
	inch	mm
XL	025	6,4
	037	9,5
	050	12,7
L	075	19,1
	100	25,4
	075	19,1
H	100	25,4
	200	50,8
	300	76,2
XH	200	50,8
	300	76,2
	400	101,6



Reference nomenclature: An alphanumeric string with blocks designating the product family SH, the number of teeth, the belt section matching the Timing Pulley profile, the width expressed in inches by hundred, the fixing mode of the pulley to shaft and finally, a block indicating a specific requirement if any.

PROFILES XL, L, H, XH. RSB*

Pitch 0,020" (5,080 mm)

PROFILE	BELT WIDTH	REFERENCE	BELT WIDTH	PITCH DIA PD	NO. TEETH	PULLEY TYPE	OUTER DIA	A	BORE		H	F	L	WEIGHT
								mm	Min mm	Max mm				
XL	9,50	TL-SH10-XL-037RSB	9,50	16,17	10	1F	15,67	23,00	5,00	5,00	9,50	14,30	19,80	0,02
		TL-SH11-XL-037RSB	9,50	17,79	11	1F	17,29	23,00	5,00	5,00	9,50	14,30	19,80	0,02
		TL-SH12-XL-037RSB	9,50	19,40	12	1F	18,90	25,00	6,00	8,00	12,70	14,30	19,80	0,03
		TL-SH13-XL-037RSB	9,50	21,02	13	1F	20,52	25,00	6,00	8,00	12,70	14,30	19,80	0,03
		TL-SH14-XL-037RSB	9,50	22,64	14	1F	22,14	28,00	6,00	9,00	14,30	14,30	19,80	0,04
		TL-SH15-XL-037RSB	9,50	24,26	15	1F	23,76	28,00	6,00	11,00	15,90	14,30	19,80	0,04
		TL-SH16-XL-037RSB	9,50	25,87	16	1F	25,37	32,00	6,00	12,00	17,50	14,30	19,80	0,05
		TL-SH17-XL-037RSB	9,50	27,49	17	1F	26,99	36,00	6,00	13,00	20,00	14,30	19,80	0,05
		TL-SH18-XL-037RSB	9,50	29,11	18	1F	28,61	36,00	6,00	13,00	20,60	14,30	19,80	0,06
		TL-SH19-XL-037RSB	9,50	30,72	19	1F	30,22	36,00	6,00	13,00	20,60	14,30	19,80	0,07
		TL-SH20-XL-037RSB	9,50	32,34	20	1F	31,84	38,00	6,00	15,00	23,80	14,30	22,20	0,08
		TL-SH21-XL-037RSB	9,50	33,96	21	1F	33,46	38,00	6,00	15,00	23,80	14,30	22,20	0,09
		TL-SH22-XL-037RSB	9,50	35,57	22	1F	35,07	42,00	6,00	16,00	25,40	14,30	22,20	0,10
		TL-SH24-XL-037RSB	9,50	38,81	24	1F	38,31	44,00	6,00	18,00	27,00	14,30	22,20	0,12
		TL-SH26-XL-037RSB	9,50	42,04	26	1F	41,54	48,00	6,00	20,00	30,00	14,30	22,20	0,14
		TL-SH27-XL-037RSB	9,50	43,66	27	1F	43,16	48,00	6,00	20,00	30,00	14,30	22,20	0,15
		TL-SH28-XL-037RSB	9,50	45,28	28	1F	44,78	51,00	6,00	20,00	30,20	14,30	22,20	0,16
		TL-SH29-XL-037RSB	9,50	46,89	29	1F	46,39	51,00	6,00	20,00	30,20	14,30	22,20	0,17
		TL-SH30-XL-037RSB	9,50	48,51	30	1F	48,01	54,00	6,00	24,00	34,90	14,30	22,20	0,19
		TL-SH32-XL-037RSB	9,50	51,74	32	1N	51,24	57,00	8,00	25,00	40,00	14,30	25,40	0,11
		TL-SH34-XL-037RSB	9,50	54,98	34	1N	54,48		8,00	25,00	38,00	14,30	25,40	0,11
		TL-SH35-XL-037RSB	9,50	56,60	35	1N	56,10		8,00	25,00	38,00	14,30	25,40	0,12
		TL-SH36-XL-037RSB	9,50	58,21	36	1N	57,71		8,00	30,00	45,00	14,30	25,40	0,13
		TL-SH38-XL-037RSB	9,50	61,45	38	1N	60,95		8,00	30,00	45,00	14,30	25,40	0,15
		TL-SH40-XL-037RSB	9,50	64,68	40	1N	64,18		8,00	30,00	45,00	14,30	25,40	0,17
		TL-SH42-XL-037RSB	9,50	67,91	42	1N	67,41		8,00	30,00	45,00	14,30	25,40	0,20
		TL-SH44-XL-037RSB	9,50	71,15	44	1N	70,65		8,00	30,00	45,00	14,30	25,40	0,15
		TL-SH45-XL-037RSB	9,50	72,77	45	1N	72,27		8,00	30,00	45,00	14,30	25,40	0,15
		TL-SH48-XL-037RSB	9,50	77,62	48	1N	77,12		8,00	30,00	45,00	14,30	25,40	0,16
		TL-SH60-XL-037RSB	9,50	97,02	60	1N	96,52		8,00	30,00	45,00	14,30	25,40	0,18
		TL-SH72-XL-037RSB	9,50	116,43	72	1N	115,93		8,00	30,00	45,00	14,30	25,40	0,23

* RSB stands for Rough Stock Bore.

PROFILE	BELT WIDTH	REFERENCE	BELT WIDTH	PITCH DIA PD	NO. TEETH	PULLEY TYPE	OUTER DIA	A	BORE		H	F	L	WEIGHT
									Min mm	Max mm				
L	12,70	TL-SH10-L-050RSB	12,70	30,32	10	1F	29,56	36,00	6,00	14,00	22,00	19,00	26,00	0,11
		TL-SH11-L-050RSB	12,70	33,35	11	1F	32,59	39,00	6,00	14,00	22,00	19,00	26,00	0,13
		TL-SH12-L-050RSB	12,70	36,38	12	1F	35,62	42,00	6,00	20,00	28,00	19,00	30,00	0,19
		TL-SH13-L-050RSB	12,70	39,41	13	1F	38,65	45,00	6,00	20,00	28,00	19,00	30,00	0,21
		TL-SH14-L-050RSB	12,70	42,45	14	1F	41,69	48,00	8,00	20,00	28,00	19,00	30,00	0,23
		TL-SH15-L-050RSB	12,70	45,48	15	1F	44,72	51,00	8,00	23,00	32,00	19,00	30,00	0,27
		TL-SH16-L-050RSB	12,70	48,51	16	1F	47,75	54,00	8,00	24,00	36,00	19,00	32,00	0,34
		TL-SH17-L-050RSB	12,70	51,54	17	1F	50,78	57,00	10,00	24,00	38,00	19,00	32,00	0,38
		TL-SH18-L-050RSB	12,70	54,57	18	1F	53,81	60,00	10,00	27,00	40,00	19,00	32,00	0,41
		TL-SH19-L-050RSB	12,70	57,61	19	1F	56,85	63,00	10,00	27,00	40,00	19,00	32,00	0,45
		TL-SH20-L-050RSB	12,70	60,64	20	1F	59,88	66,00	10,00	30,00	46,00	19,00	32,00	0,50
		TL-SH21-L-050RSB	12,70	63,67	21	1F	62,91	69,00	10,00	30,00	46,00	19,00	32,00	0,55
		TL-SH22-L-050RSB	12,70	66,70	22	1F	65,94	72,00	10,00	33,00	50,00	19,00	32,00	0,62
		TL-SH23-L-050RSB	12,70	69,73	23	1F	68,97	78,00	10,00	33,00	50,00	19,00	26,00	0,65
		TL-SH24-L-050RSB	12,70	72,77	24	1F	72,01	78,00	12,00	33,00	50,00	19,00	26,00	0,68
		TL-SH25-L-050RSB	12,70	75,80	25	1F	75,04	85,00	12,00	33,00	50,00	19,00	26,00	0,74
		TL-SH26-L-050RSB	12,70	78,83	26	1F	78,07	85,00	12,00	33,00	50,00	19,00	26,00	0,82
		TL-SH27-L-050RSB	12,70	81,86	27	1F	81,10	91,00	12,00	33,00	50,00	19,00	26,00	0,85
		TL-SH28-L-050RSB	12,70	84,89	28	1F	84,13	91,00	12,00	33,00	50,00	19,00	26,00	0,92
		TL-SH29-L-050RSB	12,70	87,93	29	1F	87,17	91,00	12,00	33,00	50,00	19,00	26,00	1,00
		TL-SH30-L-050RSB	12,70	90,96	30	1F	90,20	97,00	12,00	33,00	50,00	19,00	26,00	1,10
		TL-SH31-L-050RSB	12,70	93,99	31	1F	93,23	103,00	12,00	33,00	50,00	19,00	26,00	1,14
		TL-SH32-L-050RSB	12,70	97,02	32	1F	96,26	103,00	12,00	33,00	50,00	19,00	26,00	1,19
		TL-SH33-L-050RSB	12,70	100,05	33	1F	99,29	106,00	12,00	33,00	50,00	19,00	26,00	1,25
		TL-SH34-L-050RSB	12,70	103,08	34	1F	102,32	115,00	12,00	33,00	50,00	19,00	26,00	1,31
		TL-SH35-L-050RSB	12,70	106,12	35	1F	105,36	115,00	12,00	33,00	50,00	19,00	26,00	1,37
		TL-SH36-L-050RSB	12,70	109,15	36	1F	108,39	115,00	12,00	33,00	50,00	19,00	26,00	1,10
		TL-SH38-L-050RSB	12,70	115,21	38	1F	114,45	127,00	12,00	33,00	50,00	19,00	26,00	1,22
		TL-SH40-L-050RSB	12,70	121,28	40	1F	120,52	127,00	12,00	33,00	50,00	19,00	26,00	1,26
		TL-SH42-L-050RSB	12,70	127,34	42	1F	126,58	139,00	12,00	33,00	50,00	19,00	26,00	1,31
		TL-SH44-L-050RSB	12,70	133,40	44	1F	132,64	139,00	12,00	33,00	50,00	19,00	28,00	1,43
		TL-SH45-L-050RSB	12,70	136,44	45	1F	135,68	152,00	12,00	33,00	50,00	19,00	28,00	1,49
		TL-SH48-L-050RSB	12,70	145,53	48	1F	144,77	152,00	12,00	33,00	50,00	19,00	28,00	1,55
		TL-SH50-L-050RSB	12,70	151,60	50	5N	150,84		12,00	33,00	50,00	19,00	28,00	1,66
		TL-SH52-L-050RSB	12,70	157,66	52	5N	156,90		12,00	33,00	50,00	19,00	28,00	1,85
		TL-SH56-L-050RSB	12,70	169,79	56	5N	169,03		12,00	33,00	50,00	19,00	28,00	1,97
		TL-SH57-L-050RSB	12,70	172,82	57	5N	172,06		12,00	33,00	50,00	19,00	28,00	2,09
		TL-SH60-L-050RSB	12,70	191,91	60	5N	191,15		15,00	45,00	50,00	19,00	42,00	2,30
		TL-SH72-L-050RSB	12,70	218,30	72	5N	217,54		15,00	45,00	75,00	19,00	42,00	2,50
		TL-SH76-L-050RSB	12,70	230,43	76	5N	229,67		15,00	45,00	75,00	19,00	42,00	2,70
		TL-SH84-L-050RSB	12,70	254,68	84	5N	253,92		15,00	45,00	75,00	19,00	42,00	2,90
		TL-SH95-L-050RSB	12,70	283,03	95	5N	282,27		15,00	45,00	75,00	19,00	42,00	3,10
		TL-SH96-L-050RSB	12,70	291,06	96	5N	290,30		15,00	45,00	75,00	19,00	42,00	3,30
L	19,10	TL-SH10-L-075RSB	19,10	30,32	10	1F	29,56	36,00	6,00	14,00	22,00	25,40	32,00	0,15
		TL-SH11-L-075RSB	19,10	33,35	11	1F	32,59	39,00	6,00	14,00	22,00	25,40	32,00	0,20

NEXT >

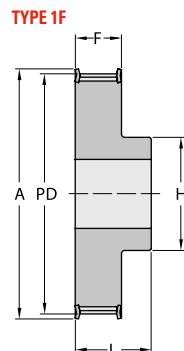
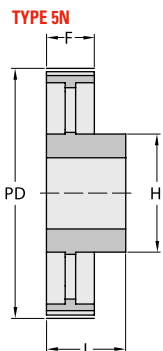

NOMENCLATOR

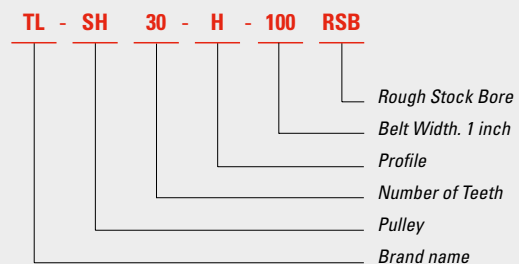

PROFILE	BELT WIDTH	REFERENCE	BELT WIDTH	PITCH DIA PD	NO. TEETH	PULLEY TYPE	OUTER DIA	A	BORE		H	F	L	WEIGHT
								mm	Min mm	Max mm	mm	mm	mm	mm
L	19,10	TL-SH12-L-075RSB	19,10	36,38	12	1F	35,62	42,00	8,00	20,00	28,00	25,40	38,00	0,23
		TL-SH13-L-075RSB	19,10	39,41	13	1F	38,65	45,00	8,00	20,00	28,00	25,40	38,00	0,26
		TL-SH14-L-075RSB	19,10	42,45	14	1F	41,69	48,00	8,00	20,00	28,00	25,40	38,00	0,28
		TL-SH15-L-075RSB	19,10	45,48	15	1F	44,72	51,00	8,00	23,00	32,00	25,40	38,00	0,36
		TL-SH16-L-075RSB	19,10	48,51	16	1F	47,75	54,00	8,00	24,00	36,00	25,40	41,00	0,45
		TL-SH17-L-075RSB	19,10	51,54	17	1F	50,78	57,00	10,00	24,00	38,00	25,40	41,00	0,50
		TL-SH18-L-075RSB	19,10	54,57	18	1F	53,81	60,00	10,00	27,00	40,00	25,40	41,00	0,55
		TL-SH19-L-075RSB	19,10	57,61	19	1F	56,85	63,00	10,00	27,00	40,00	25,40	41,00	0,60
		TL-SH20-L-075RSB	19,10	60,64	20	1F	59,88	66,00	10,00	30,00	46,00	25,40	41,00	0,65
		TL-SH21-L-075RSB	19,10	63,67	21	1F	62,91	69,00	10,00	30,00	46,00	25,40	41,00	0,70
		TL-SH22-L-075RSB	19,10	66,70	22	1F	65,94	72,00	10,00	33,00	50,00	25,40	41,00	0,75
		TL-SH23-L-075RSB	19,10	69,73	23	1F	68,97	78,00	10,00	33,00	50,00	25,40	32,00	0,81
		TL-SH24-L-075RSB	19,10	72,77	24	1F	72,01	79,00	12,00	33,00	50,00	25,40	32,00	0,85
		TL-SH25-L-075RSB	19,10	75,80	25	1F	75,04	85,00	12,00	33,00	50,00	25,40	32,00	0,94
		TL-SH26-L-075RSB	19,10	78,83	26	1F	78,07	85,00	12,00	33,00	50,00	25,40	32,00	1,02
		TL-SH27-L-075RSB	19,10	81,86	27	1F	81,10	91,00	12,00	33,00	50,00	25,40	32,00	1,09
		TL-SH28-L-075RSB	19,10	84,89	28	1F	84,13	91,00	12,00	33,00	50,00	25,40	32,00	1,20
		TL-SH29-L-075RSB	19,10	87,93	29	1F	87,17	91,00	12,00	33,00	50,00	25,40	32,00	1,33
		TL-SH30-L-075RSB	19,10	90,96	30	1F	90,20	97,00	12,00	33,00	50,00	25,40	32,00	1,33
		TL-SH31-L-075RSB	19,10	93,99	31	1F	93,23	103,00	12,00	33,00	50,00	25,40	32,00	1,39
		TL-SH32-L-075RSB	19,10	97,02	32	1F	96,26	103,00	12,00	33,00	50,00	25,40	32,00	1,45
		TL-SH33-L-075RSB	19,10	100,05	33	1F	99,29	106,00	12,00	33,00	50,00	25,40	32,00	1,56
		TL-SH34-L-075RSB	19,10	103,08	34	1F	102,32	115,00	12,00	33,00	50,00	25,40	32,00	1,70
		TL-SH35-L-075RSB	19,10	106,12	35	1F	105,36	115,00	12,00	33,00	50,00	25,40	32,00	1,78
		TL-SH36-L-075RSB	19,10	109,15	36	1F	108,39	115,00	12,00	36,00	55,00	25,40	32,00	1,50
		TL-SH38-L-075RSB	19,10	115,21	38	1F	114,45	127,00	12,00	36,00	55,00	25,40	32,00	1,63
		TL-SH40-L-075RSB	19,10	121,28	40	1F	120,52	127,00	12,00	40,00	60,00	25,40	32,00	1,79
		TL-SH42-L-075RSB	19,10	127,34	42	1F	126,58	139,00	12,00	40,00	60,00	25,40	32,00	1,95
		TL-SH44-L-075RSB	19,10	133,40	44	1F	132,64	139,00	12,00	40,00	60,00	25,40	35,00	2,05
		TL-SH45-L-075RSB	19,10	136,44	45	1F	135,68	152,00	12,00	40,00	60,00	25,40	35,00	2,10
		TL-SH48-L-075RSB	19,10	145,53	48	1F	144,77		12,00	40,00	60,00	25,40	35,00	2,15
		TL-SH50-L-075RSB	19,10	151,60	50	5N	150,84		12,00	40,00	60,00	25,40	35,00	2,25
		TL-SH52-L-075RSB	19,10	157,66	52	5N	156,90		12,00	40,00	60,00	25,40	35,00	2,55
		TL-SH56-L-075RSB	19,10	169,79	56	5N	169,03		12,00	40,00	60,00	25,40	35,00	2,78
		TL-SH57-L-075RSB	19,10	172,82	57	5N	172,06		12,00	40,00	60,00	25,40	35,00	2,91
		TL-SH60-L-075RSB	19,10	181,91	60	5N	181,15		15,00	45,00	75,00	25,40	45,00	3,10
		TL-SH72-L-075RSB	19,10	218,30	72	5N	217,54		15,00	45,00	75,00	25,40	45,00	3,29
		TL-SH76-L-075RSB	19,10	230,43	76	5N	229,67		15,00	45,00	75,00	25,40	45,00	3,48
		TL-SH84-L-075RSB	19,10	254,67	84	5N	253,91		15,00	45,00	75,00	25,40	45,00	3,67
		TL-SH95-L-075RSB	19,10	283,03	95	5N	282,27		15,00	45,00	75,00	25,40	45,00	3,76
		TL-SH96-L-075RSB	19,10	291,06	96	5N	290,30		15,00	45,00	75,00	25,40	45,00	3,85
		TL-SH120-L-075RSB	19,10	363,83	120	5N	363,07		15,00	70,00	120,00	25,40	45,00	4,50
L	25,40	TL-SH10-L-100RSB	25,40	30,32	10	1F	29,56	36,00	6,00	14,00	22,00	32,00	38,00	0,18
		TL-SH11-L-100RSB	25,40	33,35	11	1F	32,59	39,00	6,00	14,00	22,00	32,00	38,00	0,20
		TL-SH12-L-100RSB	25,40	36,38	12	1F	35,62	42,00	8,00	20,00	28,00	32,00	45,00	0,25
		TL-SH13-L-100RSB	25,40	39,41	13	1F	38,65	45,00	8,00	20,00	28,00	32,00	45,00	0,30
		TL-SH14-L-100RSB	25,40	42,45	14	1F	41,69	48,00	8,00	20,00	28,00	32,00	45,00	0,34
		TL-SH15-L-100RSB	25,40	45,48	15	1F	44,72	51,00	8,00	23,00	32,00	32,00	45,00	0,40
		TL-SH16-L-100RSB	25,40	48,51	16	1F	47,75	54,00	8,00	24,00	36,00	32,00	45,00	0,48
		TL-SH17-L-100RSB	25,40	51,54	17	1F	50,78	57,00	10,00	24,00	38,00	32,00	45,00	0,57
		TL-SH18-L-100RSB	25,40	54,57	18	1F	53,81	60,00	10,00	27,00	40,00	32,00	45,00	0,62
		TL-SH19-L-100RSB	25,40	57,61	19	1F	56,85	63,00	10,00	27,00	40,00	32,00	45,00	0,69
		TL-SH20-L-100RSB	25,40	60,64	20	1F	59,88	66,00	10,00	30,00	46,00	32,00	45,00	0,76
		TL-SH21-L-100RSB	25,40	63,67	21	1F	62,91	69,00	10,00	30,00	46,00	32,00	45,00	0,82
		TL-SH22-L-100RSB	25,40	66,70	22	1F	65,94	72,00	10,00	33,00	50,00	32,00	45,00	0,92
		TL-SH23-L-100RSB	25,40	69,73	23	1F	68,97	78,00	10,00	33,00	50,00	32,00	38,00	0,98
		TL-SH24-L-100RSB	25,40	72,77	24	1F	72,01	78,00	12,00	33,00	50,00	32,00	38,00	1,06

NEXT >



PROFILE	BELT WIDTH	REFERENCE	BELT WIDTH	PITCH DIA PD	NO. TEETH	PULLEY TYPE	OUTER DIA	A	BORE		H	F	L	WEIGHT
									Min mm	Max mm				
		TL-SH25-L-100RSB	25,40	75,80	25	1F	75,04	85,00	12,00	33,00	50,00	32,00	38,00	1,14
		TL-SH26-L-100RSB	25,40	78,83	26	1F	78,07	85,00	12,00	33,00	50,00	32,00	38,00	1,24
		TL-SH27-L-100RSB	25,40	81,86	27	1F	81,10	91,00	12,00	33,00	50,00	32,00	38,00	1,33
		TL-SH28-L-100RSB	25,40	84,89	28	1F	84,13	91,00	12,00	33,00	50,00	32,00	38,00	1,40
		TL-SH29-L-100RSB	25,40	87,93	29	1F	87,17	91,00	12,00	33,00	50,00	32,00	38,00	1,70
		TL-SH30-L-100RSB	25,40	90,96	30	1F	90,20	97,00	12,00	33,00	50,00	32,00	38,00	1,70
		TL-SH32-L-100RSB	25,40	97,02	32	1F	96,26	103,00	12,00	33,00	50,00	32,00	38,00	1,80
		TL-SH33-L-100RSB	25,40	100,05	33	1F	99,29	106,00	12,00	33,00	50,00	32,00	38,00	1,92
		TL-SH34-L-100RSB	25,40	103,08	34	1F	102,32	115,00	12,00	33,00	50,00	32,00	38,00	2,09
		TL-SH35-L-100RSB	25,40	106,12	35	1F	105,36	115,00	12,00	33,00	50,00	32,00	38,00	2,19
		TL-SH36-L-100RSB	25,40	109,15	36	1F	108,39	115,00	12,00	36,00	55,00	32,00	32,00	1,50
		TL-SH38-L-100RSB	25,40	115,21	38	1F	114,45	127,00	12,00	36,00	55,00	32,00	32,00	1,77
		TL-SH40-L-100RSB	25,40	121,28	40	1F	120,52	127,00	12,00	40,00	60,00	32,00	32,00	1,90
		TL-SH42-L-100RSB	25,40	127,34	42	1F	126,58	139,00	12,00	40,00	60,00	32,00	32,00	2,11
		TL-SH44-L-100RSB	25,40	133,40	44	1F	132,64	139,00	12,00	40,00	60,00	32,00	35,00	2,30
		TL-SH45-L-100RSB	25,40	136,44	45	1F	135,68	152,00	12,00	40,00	60,00	32,00	35,00	2,40
		TL-SH48-L-100RSB	25,40	145,53	48	1F	144,77	152,00	12,00	40,00	60,00	32,00	35,00	2,49
		TL-SH50-L-100RSB	25,40	151,60	50	5N	150,84		12,00	40,00	60,00	32,00	35,00	2,68
		TL-SH52-L-100RSB	25,40	157,66	52	5N	156,90		12,00	40,00	60,00	32,00	35,00	2,87
		TL-SH56-L-100RSB	25,40	169,79	56	5N	169,03		12,00	40,00	60,00	32,00	35,00	3,06
		TL-SH57-L-100RSB	25,40	172,82	57	5N	172,06		12,00	40,00	60,00	32,00	35,00	3,25
		TL-SH60-L-100RSB	25,40	191,91	60	5N	191,15		15,00	45,00	75,00	32,00	45,00	3,44
		TL-SH72-L-100RSB	25,40	218,30	72	5N	217,54		15,00	45,00	75,00	32,00	45,00	3,63
		TL-SH76-L-100RSB	25,40	230,43	76	5N	229,67		15,00	45,00	75,00	32,00	45,00	3,82
		TL-SH84-L-100RSB	25,40	254,68	84	5N	253,92		15,00	45,00	75,00	32,00	45,00	4,01
		TL-SH95-L-100RSB	25,40	283,03	95	5N	282,27		15,00	45,00	75,00	32,00	45,00	4,11
		TL-SH96-L-100RSB	25,40	291,06	96	5N	290,30		15,00	45,00	75,00	32,00	45,00	4,20
		TL-SH120-L-100RSB	25,40	363,83	120	5N	363,07		15,00	70,00	120,00	32,00	45,00	5,00
H	19,10	TL-SH14-H-075RSB	19,10	56,60	14	1F	55,23	63,00	10,00	27,00	40,00	27,00	40,00	0,50
		TL-SH15-H-075RSB	19,10	60,64	15	1F	59,27	67,00	10,00	30,00	46,00	27,00	40,00	0,55
		TL-SH16-H-075RSB	19,10	64,68	16	1F	63,31	71,00	10,00	30,00	45,00	27,00	40,00	0,60
		TL-SH17-H-075RSB	19,10	68,72	17	1F	67,35	75,00	10,00	30,00	46,00	27,00	40,00	0,70
		TL-SH18-H-075RSB	19,10	72,77	18	1F	71,40	79,00	12,00	36,00	55,00	27,00	40,00	0,80
		TL-SH19-H-075RSB	19,10	76,81	19	1F	75,44	83,00	12,00	40,00	60,00	27,00	40,00	1,00
		TL-SH20-H-075RSB	19,10	80,85	20	1F	79,48	87,00	12,00	41,00	62,00	27,00	40,00	1,10
		TL-SH21-H-075RSB	19,10	84,89	21	1F	83,52	91,00	12,00	43,00	67,00	27,00	40,00	1,20
		TL-SH22-H-075RSB	19,10	88,94	22	1F	87,57	95,00	12,00	45,00	70,00	27,00	40,00	1,40
		TL-SH23-H-075RSB	19,10	92,98	23	1F	91,61	98,00	12,00	46,00	72,00	27,00	40,00	1,50
		TL-SH24-H-075RSB	19,10	97,02	24	1F	95,65	103,00	12,00	47,00	75,00	27,00	40,00	1,60
		TL-SH25-H-075RSB	19,10	101,06	25	1F	99,69	107,00	12,00	47,00	75,00	27,00	40,00	1,70
		TL-SH26-H-075RSB	19,10	105,11	26	1F	103,74	111,00	15,00	54,00	80,00	27,00	40,00	1,80
		TL-SH27-H-075RSB	19,10	109,15	27	1F	107,78	115,00	15,00	54,00	80,00	27,00	40,00	1,90
		TL-SH28-H-075RSB	19,10	113,19	28	1F	111,82	119,00	15,00	54,00	80,00	27,00	40,00	2,00
		TL-SH29-H-075RSB	19,10	117,23	29	1F	115,86	123,00	15,00	54,00	80,00	27,00	40,00	2,05
		TL-SH30-H-075RSB	19,10	121,28	30	1F	119,91	127,00	15,00	54,00	80,00	27,00	40,00	2,10

NEXT >

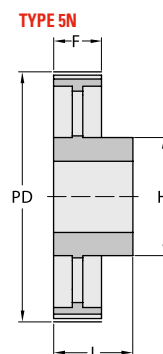
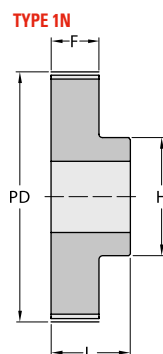

PROFILE	BELT WIDTH	REFERENCE	BELT WIDTH	PITCH DIA PD	NO. TEETH	PULLEY TYPE	OUTER DIA	A	BORE		H	F	L	WEIGHT		
								mm	Min mm	Max mm	mm	mm	mm	Kg		
H	19,10	TL-SH31-H-075RSB	19,10	125,32	31	1F	123,95	131,00	15,00	54,00	80,00	27,00	40,00	2,15		
		TL-SH32-H-075RSB	19,10	129,36	32	1F	127,99	135,00	15,00	54,00	80,00	27,00	40,00	2,20		
		TL-SH33-H-075RSB	19,10	133,40	33	1F	132,03	142,00	15,00	54,00	80,00	27,00	40,00	2,25		
		TL-SH34-H-075RSB	19,10	137,45	34	1F	136,08	142,00	15,00	54,00	80,00	27,00	40,00	2,30		
		TL-SH35-H-075RSB	19,10	141,49	35	1F	140,12	151,00	15,00	54,00	80,00	27,00	40,00	2,35		
		TL-SH36-H-075RSB	19,10	145,53	36	1F	144,16	151,00	20,00	54,00	80,00	27,00	40,00	2,40		
		TL-SH38-H-075RSB	19,10	153,62	38	1F	152,25	158,00	20,00	54,00	80,00	27,00	40,00	2,60		
		TL-SH40-H-075RSB	19,10	161,70	40	1F	160,33	168,00	20,00	54,00	80,00	27,00	40,00	2,80		
		TL-SH42-H-075RSB	19,10	169,79	42	1F	168,42	184,00	20,00	54,00	80,00	27,00	40,00	2,90		
		TL-SH44-H-075RSB	19,10	177,87	44	5F	176,50	184,00	20,00	48,00	80,00	27,00	40,00	2,70		
		TL-SH45-H-075RSB	19,10	181,91	45	5F	180,54	192,00	20,00	54,00	90,00	27,00	45,00	2,85		
		TL-SH48-H-075RSB	19,10	194,04	48	5F	192,67	200,00	20,00	54,00	90,00	27,00	45,00	3,00		
		TL-SH50-H-075RSB	19,10	202,13	50	5N	200,76		20,00	54,00	90,00	27,00	45,00	3,25		
		H	25,40	TL-SH14-H-100RSB	25,40	56,60	14	1F	55,23	63,00	10,00	27,00	40,00	33,30	45,00	0,65
				TL-SH15-H-100RSB	25,40	60,64	15	1F	59,27	67,00	10,00	30,00	46,00	33,30	45,00	0,75
TL-SH16-H-100RSB	25,40			64,67	16	1F	63,30	71,00	10,00	30,00	46,00	33,30	45,00	0,85		
TL-SH17-H-100RSB	25,40			68,72	17	1F	67,35	75,00	10,00	30,00	46,00	33,30	45,00	0,97		
TL-SH18-H-100RSB	25,40			72,77	18	1F	71,40	79,00	12,00	30,00	55,00	33,30	45,00	1,10		
TL-SH19-H-100RSB	25,40			76,81	19	1F	75,44	83,00	12,00	36,00	60,00	33,30	45,00	1,20		
TL-SH20-H-100RSB	25,40			80,85	20	1F	79,48	87,00	12,00	41,00	62,00	33,30	45,00	1,40		
TL-SH21-H-100RSB	25,40			84,89	21	1F	83,52	91,00	12,00	43,00	67,00	33,30	45,00	1,60		
TL-SH22-H-100RSB	25,40			88,94	22	1F	87,57	95,00	12,00	45,00	70,00	33,30	45,00	1,70		
TL-SH23-H-100RSB	25,40			92,98	23	1F	91,61	98,00	12,00	46,00	72,00	33,30	45,00	1,83		
TL-SH24-H-100RSB	25,40			97,03	24	1F	95,65	103,00	12,00	47,00	75,00	33,30	45,00	1,95		
TL-SH25-H-100RSB	25,40			101,06	25	1F	99,69	107,00	12,00	47,00	75,00	33,30	45,00	2,19		
TL-SH26-H-100RSB	25,40			105,11	26	1F	103,74	111,00	15,00	54,00	80,00	33,30	45,00	2,43		
TL-SH27-H-100RSB	25,40			109,15	27	1F	107,78	115,00	15,00	54,00	80,00	33,30	45,00	2,57		
TL-SH28-H-100RSB	25,40			113,18	28	1F	111,81	119,00	15,00	54,00	80,00	33,30	45,00	2,70		
TL-SH29-H-100RSB	25,40			117,23	29	1F	115,86	123,00	15,00	54,00	80,00	33,30	45,00	2,95		
TL-SH30-H-100RSB	25,40			121,29	30	1F	119,92	127,00	15,00	54,00	80,00	33,30	45,00	3,20		
TL-SH31-H-100RSB	25,40			125,32	31	1F	123,95	131,00	15,00	54,00	80,00	33,30	45,00	3,35		
TL-SH32-H-100RSB	25,40			129,36	32	1F	127,99	135,00	20,00	54,00	80,00	33,30	45,00	3,50		
TL-SH33-H-100RSB	25,40			133,40	33	1F	132,03	142,00	20,00	54,00	80,00	33,30	45,00	3,78		
TL-SH34-H-100RSB	25,40			137,45	34	1F	136,08	142,00	20,00	54,00	80,00	33,30	45,00	4,05		
TL-SH35-H-100RSB	25,40			141,49	35	1F	140,12	151,00	20,00	54,00	80,00	33,30	45,00	4,35		
TL-SH36-H-100RSB	25,40			145,53	36	1F	144,16	151,00	20,00	54,00	80,00	33,30	45,00	4,65		
TL-SH38-H-100RSB	25,40			153,62	38	1F	152,25	158,00	20,00	54,00	80,00	33,30	45,00	4,98		
TL-SH40-H-100RSB	25,40			161,70	40	1F	160,33	168,00	20,00	54,00	80,00	33,30	45,00	5,30		
TL-SH42-H-100RSB	25,40			169,79	42	1F	168,42	184,00	20,00	54,00	80,00	33,30	45,00	5,50		
TL-SH44-H-100RSB	25,40			177,87	44	5F	176,50	184,00	20,00	54,00	80,00	33,30	50,00	4,00		
TL-SH45-H-100RSB	25,40			181,91	45	5F	180,54	192,00	20,00	54,00	80,00	33,30	50,00	4,25		
TL-SH48-H-100RSB	25,40			194,03	48	5F	192,66	200,00	20,00	54,00	90,00	33,30	50,00	4,50		
TL-SH50-H-100RSB	25,40			202,13	50	5N	200,76		20,00	54,00	90,00	33,30	50,00	4,94		
TL-SH52-H-100RSB	25,40			210,21	52	5N	208,84		20,00	54,00	90,00	33,30	50,00	5,38		
TL-SH57-H-100RSB	25,40			230,42	57	5N	229,05		20,00	54,00	90,00	33,30	50,00	5,82		
TL-SH58-H-100RSB	25,40			234,47	58	5N	233,10		20,00	54,00	90,00	33,30	50,00	5,82		
TL-SH60-H-100RSB	25,40			242,55	60	5N	241,18		20,00	70,00	120,00	33,30	50,00	6,25		
TL-SH70-H-100RSB	25,40			282,98	70	5N	281,61		20,00	70,00	120,00	33,30	55,00	7,55		
TL-SH72-H-100RSB	25,40	291,06	72	5N	289,69		20,00	70,00	120,00	33,30	55,00	8,85				
TL-SH76-H-100RSB	25,40	307,23	76	5N	305,86		20,00	70,00	120,00	33,30	55,00	9,43				
TL-SH84-H-100RSB	25,40	339,57	84	5N	338,20		20,00	70,00	120,00	33,30	55,00	10,00				
TL-SH96-H-100RSB	25,40	388,08	96	5N	386,71		24,00	70,00	120,00	33,30	60,00	10,48				
TL-SH120-H-100RSB	25,40	485,10	120	5N	483,73		24,00	70,00	120,00	33,30	60,00	13,10				
TL-SH156-H-100RSB	25,40	630,63	156	5N	629,26		24,00	70,00	130,00	33,30	60,00	17,20				
H	38,10	TL-SH14-H-150RSB	38,10	56,60	14	1F	55,23	63,00	12,00	27,00	40,00	46,00	58,00	0,82		
		TL-SH15-H-150RSB	38,10	60,64	15	1F	59,27	67,00	12,00	30,00	46,00	46,00	58,00	0,96		

NEXT >



PROFILE	BELT WIDTH	REFERENCE	BELT WIDTH	PITCH DIA PD	NO. TEETH	PULLEY TYPE	OUTER DIA	A	BORE		H	F	L	WEIGHT
									Min mm	Max mm				
		TL-SH16-H-150RSB	38,10	64,67	16	1F	63,30	71,00	12,00	30,00	46,00	46,00	58,00	1,10
		TL-SH17-H-150RSB	38,10	68,72	17	1F	67,35	75,00	12,00	30,00	46,00	46,00	58,00	1,30
		TL-SH18-H-150RSB	38,10	72,77	18	1F	71,40	79,00	12,00	30,00	55,00	46,00	58,00	1,50
		TL-SH19-H-150RSB	38,10	76,81	19	1F	75,44	83,00	12,00	36,00	60,00	46,00	58,00	1,70
		TL-SH20-H-150RSB	38,10	80,85	20	1F	79,48	87,00	12,00	41,00	62,00	46,00	58,00	1,80
		TL-SH21-H-150RSB	38,10	84,89	21	1F	83,52	91,00	12,00	43,00	67,00	46,00	58,00	2,20
		TL-SH22-H-150RSB	38,10	88,94	22	1F	87,57	95,00	12,00	45,00	70,00	46,00	58,00	2,30
		TL-SH23-H-150RSB	38,10	92,98	23	1F	91,61	98,00	12,00	46,00	72,00	46,00	58,00	2,45
		TL-SH24-H-150RSB	38,10	97,03	24	1F	95,66	103,00	12,00	47,00	75,00	46,00	58,00	2,60
		TL-SH25-H-150RSB	38,10	101,06	25	1F	99,69	107,00	12,00	47,00	75,00	46,00	58,00	2,90
		TL-SH26-H-150RSB	38,10	105,11	26	1F	103,74	111,00	15,00	54,00	80,00	46,00	58,00	3,20
		TL-SH27-H-150RSB	38,10	109,15	27	1F	107,78	115,00	15,00	54,00	80,00	46,00	58,00	3,30
		TL-SH28-H-150RSB	38,10	113,19	28	1F	111,81	119,00	15,00	54,00	80,00	46,00	58,00	3,39
		TL-SH29-H-150RSB	38,10	117,23	29	1F	115,86	123,00	15,00	54,00	80,00	46,00	58,00	3,75
		TL-SH30-H-150RSB	38,10	121,29	30	1F	119,92	127,00	15,00	54,00	80,00	46,00	58,00	4,10
		TL-SH31-H-150RSB	38,10	125,32	31	1F	123,95	131,00	15,00	54,00	80,00	46,00	58,00	4,43
		TL-SH32-H-150RSB	38,10	129,36	32	1F	127,99	135,00	20,00	54,00	80,00	46,00	58,00	4,77
		TL-SH33-H-150RSB	38,10	133,40	33	1F	132,03	142,00	20,00	54,00	80,00	46,00	58,00	5,08
		TL-SH34-H-150RSB	38,10	137,45	34	1F	136,08	142,00	20,00	54,00	80,00	46,00	58,00	5,40
		TL-SH35-H-150RSB	38,10	141,49	35	1F	140,12	151,00	20,00	54,00	80,00	46,00	58,00	5,71
		TL-SH36-H-150RSB	38,10	145,53	36	1F	144,16	151,00	20,00	54,00	80,00	46,00	58,00	6,02
		TL-SH38-H-150RSB	38,10	153,62	38	1F	152,25	158,00	20,00	54,00	80,00	46,00	58,00	6,76
		TL-SH40-H-150RSB	38,10	161,70	40	1F	160,33	168,00	20,00	54,00	80,00	46,00	58,00	7,50
		TL-SH42-H-150RSB	38,10	169,79	42	1F	168,42	184,00	20,00	54,00	80,00	46,00	58,00	8,00
		TL-SH44-H-150RSB	38,10	177,87	44	5F	176,50	184,00	20,00	48,00	80,00	46,00	58,00	5,00
		TL-SH45-H-150RSB	38,10	181,91	45	5F	180,54	192,00	20,00	48,00	80,00	46,00	58,00	5,05
		TL-SH48-H-150RSB	38,10	194,03	48	5F	192,66	200,00	20,00	54,00	90,00	46,00	65,00	5,10
		TL-SH50-H-150RSB	38,10	202,13	50	5N	200,76		20,00	54,00	90,00	46,00	65,00	5,75
		TL-SH52-H-150RSB	38,10	210,21	52	5N	208,84		20,00	54,00	90,00	46,00	65,00	6,40
		TL-SH57-H-150RSB	38,10	230,43	57	5N	229,06		20,00	54,00	90,00	46,00	65,00	6,75
		TL-SH58-H-150RSB	38,10	234,47	58	5N	233,10		20,00	54,00	90,00	46,00	65,00	7,05
		TL-SH60-H-150RSB	38,10	242,55	60	5N	241,18		20,00	70,00	120,00	46,00	65,00	7,70
		TL-SH70-H-150RSB	38,10	282,98	70	5N	281,61		20,00	70,00	120,00	46,00	65,00	8,20
		TL-SH72-H-150RSB	38,10	291,06	72	5N	289,69		20,00	70,00	120,00	46,00	65,00	8,70
		TL-SH76-H-150RSB	38,10	307,23	76	5N	305,86		20,00	70,00	120,00	46,00	65,00	9,67
		TL-SH84-H-150RSB	38,10	339,57	84	5N	338,20		20,00	70,00	120,00	46,00	65,00	10,64
		TL-SH96-H-150RSB	38,10	388,08	96	5N	386,71		24,00	70,00	120,00	46,00	65,00	13,40
		TL-SH120-H-150RSB	38,10	485,10	120	5N	483,73		24,00	70,00	120,00	46,00	65,00	15,70
		TL-SH156-H-150RSB	38,10	630,63	156	5N	629,26		24,00	70,00	130,00	46,00	65,00	19,10
H	50,80	TL-SH14-H-200RSB	50,80	56,60	14	1F	55,23	63,00	12,00	27,00	40,00	59,50	70,00	1,25
		TL-SH15-H-200RSB	50,80	60,64	15	1F	59,27	67,00	12,00	30,00	46,00	59,50	70,00	1,33
		TL-SH16-H-200RSB	50,80	64,67	16	1F	63,30	71,00	12,00	30,00	46,00	59,50	70,00	1,40
		TL-SH17-H-200RSB	50,80	68,72	17	1F	67,35	75,00	12,00	30,00	46,00	59,50	70,00	1,67
		TL-SH18-H-200RSB	50,80	72,77	18	1F	71,40	79,00	12,00	30,00	55,00	59,50	70,00	1,94
		TL-SH19-H-200RSB	50,80	76,81	19	1F	75,44	83,00	12,00	36,00	60,00	59,50	70,00	2,18

NEXT >

TYPE 1F

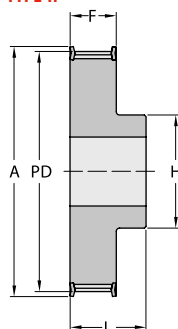

TYPE 5N

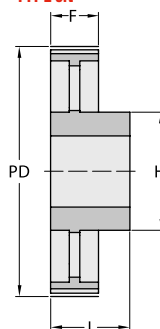

TYPE 5F

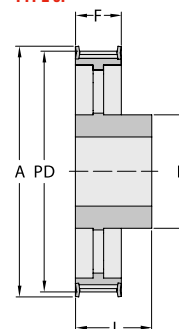

PROFILE	BELT WIDTH	REFERENCE	BELT WIDTH	PITCH DIA PD	NO. TEETH	PULLEY TYPE	OUTER DIA	A	BORE		H	F	L	WEIGHT
								mm	Min mm	Max mm	mm	mm	mm	mm
H	50,80	TL-SH20-H-200RSB	50,80	80,85	20	1F	79,48	87,00	12,00	41,00	62,00	59,50	70,00	2,43
		TL-SH21-H-200RSB	50,80	84,89	21	1F	83,52	91,00	12,00	43,00	67,00	59,50	70,00	2,60
		TL-SH22-H-200RSB	50,80	88,94	22	1F	87,57	95,00	12,00	45,00	70,00	59,50	70,00	2,80
		TL-SH23-H-200RSB	50,80	92,98	23	1F	91,61	98,00	12,00	46,00	72,00	59,50	70,00	2,89
		TL-SH24-H-200RSB	50,80	97,03	24	1F	95,66	103,00	12,00	47,00	75,00	59,50	70,00	2,97
		TL-SH25-H-200RSB	50,80	101,06	25	1F	99,69	107,00	12,00	47,00	75,00	59,50	70,00	2,89
		TL-SH26-H-200RSB	50,80	105,11	26	1F	103,74	111,00	15,00	54,00	80,00	59,50	70,00	3,90
		TL-SH27-H-200RSB	50,80	109,15	27	1F	107,78	115,00	15,00	54,00	80,00	59,50	70,00	3,44
		TL-SH28-H-200RSB	50,80	113,18	28	1F	111,81	119,00	15,00	54,00	80,00	59,50	70,00	4,60
		TL-SH29-H-200RSB	50,80	117,23	29	1F	115,86	123,00	15,00	54,00	80,00	59,50	70,00	4,80
		TL-SH30-H-200RSB	50,80	121,29	30	1F	119,92	127,00	15,00	54,00	80,00	59,50	70,00	5,00
		TL-SH31-H-200RSB	50,80	125,32	31	1F	123,95	131,00	15,00	54,00	80,00	59,50	70,00	5,47
		TL-SH32-H-200RSB	50,80	129,36	32	1F	127,99	135,00	20,00	54,00	80,00	59,50	70,00	5,93
		TL-SH33-H-200RSB	50,80	133,40	33	1F	132,03	142,00	20,00	54,00	80,00	59,50	70,00	6,33
		TL-SH34-H-200RSB	50,80	137,45	34	1F	136,08	142,00	20,00	54,00	80,00	59,50	70,00	6,73
		TL-SH35-H-200RSB	50,80	141,49	35	1F	140,12	151,00	20,00	54,00	80,00	59,50	70,00	7,13
		TL-SH36-H-200RSB	50,80	145,53	36	1F	144,16	151,00	20,00	54,00	80,00	59,50	70,00	7,53
		TL-SH38-H-200RSB	50,80	153,62	38	1F	152,25	158,00	20,00	54,00	80,00	59,50	70,00	8,32
		TL-SH40-H-200RSB	50,80	161,70	40	1F	160,33	168,00	20,00	54,00	80,00	59,50	70,00	9,11
		TL-SH42-H-200RSB	50,80	169,79	42	1F	168,42	184,00	20,00	54,00	80,00	59,50	70,00	9,70
		TL-SH44-H-200RSB	50,80	177,87	44	5F	176,50	184,00	20,00	48,00	80,00	59,50	70,00	5,00
		TL-SH45-H-300RSB	50,80	181,91	45	5F	180,54	192,00	20,00	48,00	80,00	59,50	70,00	5,37
		TL-SH48-H-200RSB	50,80	194,03	48	5F	192,66	200,00	20,00	54,00	90,00	59,50	75,00	5,73
		TL-SH50-H-200RSB	50,80	202,13	50	5N	200,76		20,00	54,00	90,00	59,50	75,00	6,62
		TL-SH52-H-200RSB	51,80	210,21	52	5N	208,84		20,00	54,00	90,00	59,50	75,00	7,50
		TL-SH57-H-200RSB	52,80	230,43	57	5N	229,05		20,00	54,00	90,00	59,50	75,00	8,76
		TL-SH58-H-200RSB	53,80	234,47	58	5N	233,10		20,00	54,00	90,00	59,50	75,00	8,39
		TL-SH60-H-200RSB	54,80	242,55	60	5N	241,18		20,00	70,00	120,00	59,50	75,00	9,27
		TL-SH70-H-200RSB	55,80	282,98	70	5N	281,61		20,00	70,00	120,00	59,50	75,00	9,80
		TL-SH72-H-200RSB	56,80	291,06	72	5N	289,69		20,00	70,00	120,00	59,50	75,00	10,32
		TL-SH76-H-200RSB	57,80	307,23	76	5N	305,86		20,00	70,00	120,00	59,50	75,00	11,41
		TL-SH84-H-200RSB	58,80	339,57	84	5N	338,20		20,00	70,00	120,00	59,50	75,00	12,50
		TL-SH96-H-200RSB	59,80	388,08	96	5N	386,71		24,00	70,00	120,00	59,50	75,00	14,00
		TL-SH120-H-200RSB	60,80	485,10	120	5N	483,73		24,00	70,00	120,00	59,50	75,00	18,10
		TL-SH156-H-200RSB	61,80	630,63	156	5N	629,26		24,00	70,00	130,00	59,50	75,00	22,00
H	76,20	TL-SH14-H-300RSB	76,20	56,60	14	1F	55,23	63,00	14,00	27,00	40,00	85,50	100,00	1,80
		TL-SH15-H-300RSB	76,20	60,64	15	1F	59,27	67,00	14,00	30,00	46,00	85,50	100,00	1,90
		TL-SH16-H-300RSB	76,20	64,67	16	1F	63,30	71,00	14,00	30,00	46,00	85,50	100,00	2,00
		TL-SH17-H-300RSB	76,20	68,72	17	1F	67,35	75,00	14,00	30,00	46,00	85,50	100,00	2,24
		TL-SH18-H-300RSB	76,20	72,77	18	1F	71,40	79,00	14,00	30,00	55,00	85,50	100,00	2,47
		TL-SH19-H-300RSB	76,20	76,81	19	1F	75,44	83,00	14,00	36,00	60,00	85,50	100,00	2,90
		TL-SH20-H-300RSB	76,20	80,85	20	1F	79,48	87,00	15,00	41,00	62,00	85,50	100,00	3,20
		TL-SH21-H-300RSB	76,20	84,89	21	1F	83,52	91,00	15,00	43,00	67,00	85,50	100,00	3,60
		TL-SH22-H-300RSB	76,20	88,94	22	1F	87,57	95,00	15,00	45,00	70,00	85,50	100,00	4,00
		TL-SH23-H-300RSB	76,20	92,98	23	1F	91,61	98,00	15,00	46,00	72,00	85,50	100,00	4,35
		TL-SH24-H-300RSB	76,20	97,03	24	1F	95,65	103,00	15,00	47,00	75,00	85,50	100,00	4,70
		TL-SH25-H-300RSB	76,20	101,06	25	1F	99,69	107,00	15,00	47,00	75,00	85,50	100,00	5,24
		TL-SH26-H-300RSB	76,20	105,11	26	1F	103,74	111,00	15,00	54,00	80,00	85,50	100,00	5,78
		TL-SH27-H-300RSB	76,20	109,15	27	1F	107,78	115,00	15,00	54,00	80,00	85,50	100,00	6,16
		TL-SH28-H-300RSB	76,20	113,18	28	1F	111,81	119,00	15,00	54,00	80,00	85,50	100,00	6,54
		TL-SH29-H-300RSB	76,20	117,23	29	1F	115,86	123,00	15,00	54,00	80,00	85,50	100,00	6,77
		TL-SH30-H-300RSB	76,20	121,29	30	1F	119,92	127,00	15,00	54,00	80,00	85,50	100,00	7,00
		TL-SH31-H-300RSB	76,20	125,32	31	1F	123,95	131,00	15,00	54,00	80,00	85,50	100,00	7,83
		TL-SH32-H-300RSB	76,20	129,36	32	1F	127,99	135,00	20,00	54,00	80,00	85,50	100,00	8,66
		TL-SH33-H-300RSB	76,20	133,40	33	1F	132,03	142,00	20,00	54,00	80,00	85,50	100,00	9,23
		TL-SH34-H-300RSB	76,20	137,45	34	1F	136,08	142,00	20,00	54,00	80,00	85,50	100,00	9,79
		TL-SH35-H-300RSB	76,20	141,49	35	1F	140,10	151,00	20,00	54,00	80,00	85,50	100,00	10,36

NEXT >



PROFILE	BELT WIDTH	REFERENCE	BELT WIDTH	PITCH DIA PD	NO. TEETH	PULLEY TYPE	OUTER DIA	A	BORE		H	F	L	WEIGHT
								mm	Min mm	Max mm	mm	mm	mm	Kg
		TL-SH36-H-300RSB	76,20	145,53	36	1F	144,16	151,00	20,00	54,00	80,00	85,50	100,00	10,92
		TL-SH38-H-300RSB	76,20	153,62	38	1F	152,25	158,00	20,00	54,00	80,00	85,50	100,00	12,20
		TL-SH40-H-300RSB	76,20	161,70	40	1F	160,33	168,00	20,00	54,00	80,00	85,50	100,00	13,50
		TL-SH42-H-300RSB	76,20	169,79	42	1F	168,42	184,00	20,00	54,00	80,00	85,50	100,00	14,50
		TL-SH44-H-300RSB	76,20	177,87	44	5F	176,5	184,00	20,00	48,00	80,00	85,50	100,00	8,06
		TL-SH48-H-300RSB	76,20	194,03	48	5F	192,66	200,00	20,00	54,00	90,00	85,50	100,00	9,67
		TL-SH50-H-300RSB	76,20	202,13	50	5N	200,76		20,00	54,00	90,00	85,50	100,00	10,87
		TL-SH57-H-300RSB	76,20	230,43	57	5N	229,05		20,00	54,00	90,00	85,50	100,00	11,92
		TL-SH58-H-300RSB	76,20	234,47	58	5N	233,10		20,00	54,00	90,00	85,50	100,00	12,07
		TL-SH60-H-300RSB	76,20	242,55	60	5N	241,18		20,00	70,00	120,00	85,50	100,00	13,3
		TL-SH72-H-300RSB	76,20	291,06	72	5N	289,69		20,00	70,00	120,00	85,50	100,00	15,70
		TL-SH76-H-300RSB	76,20	307,24	76	5N	305,87		20,00	70,00	120,00	85,50	100,00	16,17
		TL-SH84-H-300RSB	76,20	339,57	84	5N	338,20		20,00	70,00	120,00	85,50	100,00	17,10
		TL-SH96-H-300RSB	76,20	388,08	96	5N	386,72		24,00	70,00	120,00	85,50	100,00	20,40
		TL-SH120-H-300RSB	76,20	485,12	120	5N	483,75		24,00	70,00	120,00	85,50	100,00	27,80
		TL-SH156-H-300RSB	76,20	630,63	156	5N	629,26		24,00	70,00	130,00	85,50	100,00	35,00
XH	50,80	TL-SH18-XH-200RSB	50,80	127,34	18	1F	124,54	141,00	24,00	67,00	100,00	65,10	80,00	5,00
		TL-SH19-XH-200RSB	50,80	134,41	19	1F	131,61	146,00	24,00	67,00	100,00	65,10	80,00	5,50
		TL-SH20-XH-200RSB	50,80	141,49	20	1F	138,69	155,00	24,00	67,00	100,00	65,10	80,00	6,00
		TL-SH21-XH-200RSB	50,80	148,56	21	1F	145,76	169,00	24,00	73,00	110,00	65,10	80,00	6,60
		TL-SH22-XH-200RSB	50,80	155,64	22	1F	152,84	169,00	24,00	73,00	110,00	65,10	80,00	7,20
		TL-SH24-XH-200RSB	50,80	169,79	24	1F	166,99	183,00	24,00	80,00	120,00	65,10	80,00	8,60
		TL-SH25-XH-200RSB	50,80	176,86	25	1F	174,06	198,00	24,00	80,00	120,00	65,10	80,00	9,40
		TL-SH26-XH-200RSB	50,80	183,93	26	1F	181,13	198,00	24,00	80,00	120,00	65,10	80,00	9,70
		TL-SH27-XH-200RSB	50,80	191,01	27	1F	188,21	212,00	24,00	80,00	120,00	65,10	80,00	9,90
		TL-SH28-XH-200RSB	50,80	198,09	28	1F	195,29	212,00	24,00	80,00	120,00	65,10	80,00	10,00
		TL-SH30-XH-200RSB	50,80	212,23	30	1F	209,43	226,00	24,00	80,00	120,00	65,10	80,00	10,40
		TL-SH32-XH-200RSB	51,80	226,38	32	1F	223,58	240,00	24,00	80,00	120,00	65,10	80,00	11,20
		TL-SH34-XH-200RSB	52,80	240,53	34	1F	237,73	256,00	24,00	80,00	120,00	65,10	80,00	12,60
		TL-SH38-XH-200RSB	53,80	268,83	38	5N	266,03		28,00	100,00	150,00	65,10	80,00	14,60
		TL-SH40-XH-200RSB	54,80	282,98	40	5N	280,18		28,00	100,00	150,00	65,10	100,00	16,00
		TL-SH48-XH-200RSB	55,80	339,57	48	5N	336,77		28,00	100,00	150,00	65,10	100,00	18,40
		TL-SH60-XH-200RSB	56,80	424,47	60	5N	421,67		28,00	100,00	150,00	65,10	100,00	24,30
XH	76,20	TL-SH18-XH-300RSB	76,20	127,34	18	1F	124,54	141,00	28,00	67,00	100,00	92,10	110,00	6,80
		TL-SH19-XH-300RSB	76,20	134,41	19	1F	131,61	146,00	28,00	67,00	100,00	92,10	110,00	7,10
		TL-SH20-XH-300RSB	76,20	141,49	20	1F	138,69	155,00	28,00	67,00	100,00	92,10	110,00	7,40
		TL-SH21-XH-300RSB	76,20	148,56	21	1F	145,76	169,00	28,00	73,00	110,00	92,10	110,00	8,20
		TL-SH22-XH-300RSB	76,20	155,64	22	1F	152,84	169,00	28,00	73,00	110,00	92,10	110,00	9,00
		TL-SH24-XH-300RSB	76,20	169,79	24	1F	166,99	183,00	28,00	80,00	120,00	92,10	110,00	10,60
		TL-SH25-XH-300RSB	76,20	176,86	25	1F	174,06	198,00	28,00	80,00	120,00	92,10	110,00	11,80
		TL-SH26-XH-300RSB	76,20	183,93	26	1F	181,13	198,00	28,00	80,00	120,00	92,10	110,00	12,00
		TL-SH27-XH-300RSB	76,20	191,01	27	1F	188,21	212,00	28,00	80,00	120,00	92,10	110,00	12,50
		TL-SH28-XH-300RSB	76,20	198,09	28	1F	195,29	212,00	28,00	80,00	150,00	92,10	110,00	13,00
		TL-SH30-XH-300RSB	76,20	212,23	30	1F	209,43	226,00	28,00	80,00	150,00	92,10	110,00	13,75

NEXT >

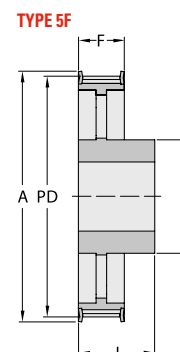
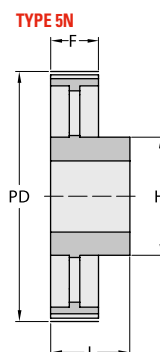
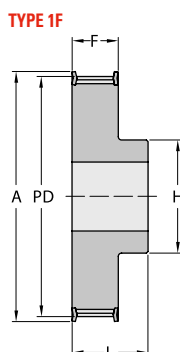

PROFILE	BELT WIDTH	REFERENCE	BELT WIDTH	PITCH DIA PD	NO. TEETH	PULLEY TYPE	OUTER DIA	A	BORE		H	F	L	WEIGHT
								mm	Min mm	Max mm				
XH	76,20	TL-SH32-XH-300RSB	76,20	226,38	32	1F	223,58	240,00	28,00	80,00	150,00	92,10	110,00	14,70
		TL-SH34-XH-300RSB	76,20	240,53	34	1F	237,73	256,00	28,00	80,00	150,00	92,10	110,00	16,30
		TL-SH38-XH-300RSB	76,20	268,83	38	5N	266,03		32,00	100,00	150,00	92,10	120,00	18,30
		TL-SH40-XH-300RSB	76,20	282,98	40	5N	280,18		32,00	100,00	150,00	92,10	120,00	19,90
		TL-SH48-XH-300RSB	76,20	339,57	48	5N	336,77		32,00	100,00	175,00	92,10	120,00	22,50
		TL-SH60-XH-300RSB	76,20	424,47	60	5N	421,67		32,00	100,00	175,00	92,10	120,00	31,50
XH	101,60	TL-SH18-XH-400RSB	76,20	127,34	18	1F	124,54	141,00	32,00	67,00	100,00	119,00	132,00	8,50
		TL-SH19-XH-400RSB	76,20	134,41	19	1F	131,61	146,00	32,00	67,00	100,00	119,00	132,00	9,00
		TL-SH20-XH-400RSB	76,20	141,49	20	1F	138,69	155,00	32,00	67,00	100,00	119,00	132,00	9,40
		TL-SH21-XH-400RSB	76,20	148,56	21	1F	145,76	169,00	32,00	73,00	110,00	119,00	132,00	10,50
		TL-SH22-XH-400RSB	76,20	155,64	22	1F	152,84	169,00	32,00	73,00	110,00	119,00	132,00	11,50
		TL-SH24-XH-400RSB	76,20	169,79	24	1F	166,99	183,00	32,00	80,00	120,00	119,00	132,00	13,40
		TL-SH25-XH-400RSB	76,20	176,86	25	1F	174,06	198,00	32,00	80,00	120,00	119,00	132,00	14,50
		TL-SH26-XH-400RSB	76,20	183,93	26	1F	181,13	198,00	32,00	80,00	120,00	119,00	132,00	15,60
		TL-SH27-XH-400RSB	76,20	191,01	27	1F	188,21	212,00	32,00	80,00	120,00	119,00	132,00	15,10
		TL-SH28-XH-400RSB	76,20	198,09	28	1F	195,29	212,00	32,00	100,00	150,00	119,00	132,00	14,50
		TL-SH30-XH-400RSB	76,20	212,23	30	1F	209,43	227,00	32,00	100,00	150,00	119,00	132,00	16,00
		TL-SH32-XH-400RSB	76,20	226,38	32	1F	223,58	240,00	32,00	100,00	150,00	119,00	132,00	18,00
		TL-SH34-XH-400RSB	76,20	240,53	34	1F	237,73	256,00	32,00	100,00	150,00	119,00	132,00	20,00
		TL-SH38-XH-400RSB	76,20	268,83	38	5N	266,03		32,00	100,00	150,00	119,00	132,00	22,00
		TL-SH40-XH-400RSB	76,20	282,98	40	5N	280,18		32,00	100,00	150,00	119,00	132,00	24,00
		TL-SH48-XH-400RSB	76,20	339,57	48	5N	336,77		32,00	110,00	175,00	119,00	132,00	30,80
		TL-SH60-XH-400RSB	76,20	424,47	60	5N	421,67		32,00	110,00	175,00	119,00	132,00	36,20

TYPE 1F

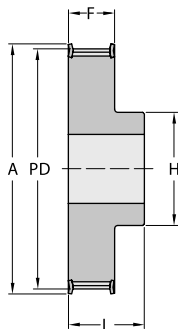

TYPE 5N

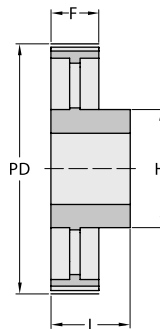

TYPE 5F

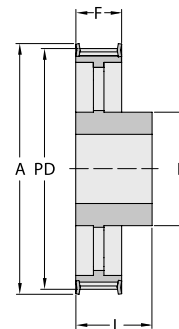

CLASSICAL TIMING PULLEYS. PROFILES XL, L, H, XH. TB TAPER BUSH

BELT PROFILE	BELT WIDTH	
	inch	mm
XL	025	6,4
	037	9,5
	050	12,7
L	075	19,1
	100	25,4
	075	19,1
H	100	25,4
	200	50,8
	300	76,2
XH	200	50,8
	300	76,2
	400	101,6



Reference nomenclature: An alphanumeric string with blocks designating the product family SH, the number of teeth, the belt section matching the Timing Pulley profile, the width expressed in inches by ten, the fixing mode of the pulley to shaft and finally a block indicating a specific requirement if any.

PROFILES L, H, XH. TB TAPER BUSH

PROFILE	BELT WIDTH	REFERENCE	BELT WIDTH	PITCH DIA PD	NO. TEETH	PULLEY TYPE	BUSH TYPE	OUTER DIA	A			F	K	L	M	H	WEIGHT
									mm	Min mm	Max mm						
L	12,70	TL-SH18-L-050TB	12,70	54,57	18	3F	1108	53,81	60,00	9,00	28,00	19,10		22,00	3,00	45,00	0,18
		TL-SH19-L-050TB	12,70	57,61	19	3F	1108	56,85	63,00	9,00	28,00	19,10		22,00	3,00	45,00	0,21
		TL-SH20-L-050TB	12,70	60,64	20	3F	1108	59,88	66,00	9,00	28,00	19,10		22,00	3,00	47,00	0,24
		TL-SH21-L-050TB	12,70	63,67	21	3F	1108	62,91	69,00	9,00	28,00	19,10		22,00	3,00	49,00	0,30
		TL-SH22-L-050TB	12,70	66,70	22	3F	1108	65,94	72,00	9,00	28,00	19,10		22,00	3,00	53,00	0,36
		TL-SH23-L-050TB	12,70	69,73	23	3F	1108	68,97	78,00	9,00	28,00	19,10		22,00	3,00	54,00	0,39
		TL-SH24-L-050TB	12,70	72,77	24	3F	1108	72,01	78,00	9,00	28,00	19,10		22,00	3,00	54,00	0,42
		TL-SH25-L-050TB	12,70	75,80	25	3F	1108	75,04	85,00	9,00	28,00	19,10		22,00	3,00	56,00	0,49
		TL-SH26-L-050TB	12,70	78,83	26	3F	1108	78,07	85,00	9,00	28,00	19,10		22,00	3,00	60,00	0,54
		TL-SH27-L-050TB	12,70	81,86	27	3F	1108	81,10	91,00	9,00	28,00	19,10		22,00	3,00	62,00	0,61
		TL-SH28-L-050TB	12,70	84,89	28	3F	1108	84,13	91,00	9,00	28,00	19,10		22,00	3,00	63,00	0,64
		TL-SH30-L-050TB	12,70	90,96	30	3F	1108	89,30	97,00	9,00	28,00	19,10		22,00	3,00	70,00	0,77
		TL-SH32-L-050TB	12,70	97,02	32	3F	1108	96,26	103,00	9,00	28,00	19,10		22,00	3,00	74,00	0,89
		TL-SH36-L-050TB	12,70	109,15	36	3F	1108	108,39	115,00	9,00	28,00	19,10		22,00	3,00	85,00	1,18
		TL-SH40-L-050TB	12,70	121,28	40	3F	1610	120,52	127,00	14,00	42,00	19,10		25,00	6,00	90,00	1,35
		TL-SH44-L-050TB	12,70	133,40	44	3F	1610	132,64	139,00	14,00	42,00	19,10		25,00	6,00	90,00	1,60
		TL-SH48-L-050TB	12,70	145,53	48	9F	1610	144,77	152,00	14,00	42,00	19,10		25,00	6,00	92,00	1,80
		TL-SH60-L-050TB	12,70	181,91	60	9N	1610	181,15		14,00	42,00	19,10	3,00	25,00	3,00	92,00	2,46
		TL-SH72-L-050TB	12,70	218,30	72	9N	1610	217,54		14,00	42,00	19,10	3,00	25,00	3,00	92,00	3,29
		TL-SH84-L-050TB	12,70	254,68	84	9N	1610	253,92		14,00	42,00	19,10	3,00	25,00	3,00	92,00	4,12
TL-SH96-L-050TB	12,70	291,06	96	9N	2012	290,30		14,00	50,00	19,10	6,50	32,00	6,50	111,00	4,55		
TL-SH120-L-050TB	12,70	363,83	120	9N	2012	363,07		14,00	50,00	19,10	6,50	32,00	6,50	111,00	5,71		
L	19,10	TL-SH18-L-075TB	19,10	54,57	18	2F	1108	53,81	60,00	9,00	28,00	25,40		25,00			0,20
		TL-SH19-L-075TB	19,10	57,61	19	2F	1108	56,85	63,00	9,00	28,00	25,40		25,00			0,30
		TL-SH20-L-075TB	19,10	60,64	20	2F	1108	59,88	66,00	9,00	28,00	25,40		25,00			0,30
		TL-SH21-L-075TB	19,10	63,67	21	2F	1108	62,91	69,00	9,00	28,00	25,40		25,00			0,40
		TL-SH22-L-075TB	19,10	66,70	22	2F	1108	65,94	72,00	9,00	28,00	25,40		25,00			0,40
		TL-SH23-L-075TB	19,10	69,73	23	2F	1108	68,97	78,00	9,00	28,00	25,40		25,00			0,50
		TL-SH24-L-075TB	19,10	72,77	24	2F	1108	72,01	78,00	9,00	28,00	25,40		25,00			0,50
		TL-SH25-L-075TB	19,10	75,80	25	2F	1108	75,04	85,00	9,00	28,00	25,40		25,00			0,60
		TL-SH26-L-075TB	19,10	78,83	26	2F	1108	78,07	85,00	9,00	28,00	25,40		25,00			0,70
		TL-SH27-L-075TB	19,10	81,86	27	2F	1108	81,10	91,00	9,00	28,00	25,40		25,00			0,70
		TL-SH28-L-075TB	19,10	84,89	28	2F	1108	84,13	91,00	9,00	28,00	25,40		25,00			0,80
		TL-SH30-L-075TB	19,10	90,96	30	2F	1108	90,20	97,00	9,00	28,00	25,40		25,00			1,00
		TL-SH32-L-075TB	19,10	97,02	32	2F	1108	96,26	103,00	9,00	28,00	25,40		25,00			1,10
		TL-SH36-L-075TB	19,10	109,15	36	2F	1610	108,39	115,00	14,00	42,00	25,40		25,00			1,20
		TL-SH40-L-075TB	19,10	121,28	40	2F	1610	120,52	127,00	14,00	42,00	25,40		25,00			1,60
		TL-SH44-L-075TB	19,10	133,40	44	2F	1610	132,64	139,00	14,00	42,00	25,40		25,00			1,90
		TL-SH48-L-075TB	19,10	145,53	48	7F	1610	144,77	152,00	14,00	42,00	25,40		25,00		92,00	2,20
		TL-SH60-L-075TB	19,10	181,91	60	7N	1610	181,15		14,00	42,00	25,40		25,00		92,00	3,00
		TL-SH72-L-075TB	19,10	218,30	72	8N	1610	217,54		14,00	42,00	25,40		25,00		92,00	4,00

NEXT >

TYPE 2F

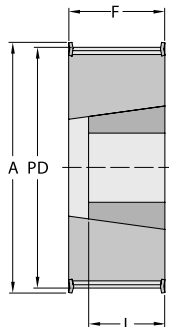

TYPE 3F

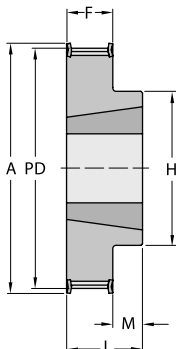

TYPE 7N

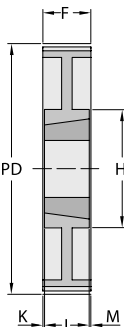

TYPE 8N

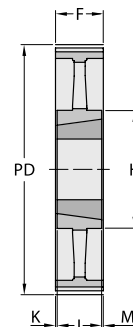

TYPE 9N

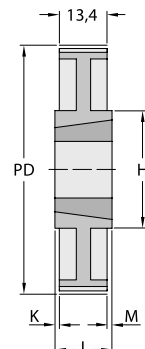

PROFILE	BELT WIDTH	REFERENCE	BELT WIDTH	PITCH DIA PD	NO. TEETH	PULLEY TYPE	BUSH TYPE	OUTER DIA	A		BORE		F	K	L	M	H	WEIGHT		
									mm	mm	Min mm	Max mm							mm	mm
L	19,10	TL-SH84-L-075TB	19,10	254,68	84	9N	2012	253,92			14,00	50,00	25,40	3,50	32,00	3,50	106,00	5,20		
		TL-SH96-L-075TB	19,10	291,06	96	9N	2012	290,30			14,00	50,00	25,40	3,50	32,00	3,50	106,00	6,50		
		TL-SH120-L-075TB	19,10	363,83	120	9N	2012	363,07			14,00	50,00	25,40	3,50	32,00	3,50	106,00	7,60		
L	25,40	TL-SH18-L-100TB	25,40	54,57	18	4F	1108	53,81	60,00	9,00	28,00	31,80	10,00	22,00				0,27		
		TL-SH19-L-100TB	25,40	57,61	19	4F	1108	56,85	63,00	9,00	28,00	31,80	10,00	22,00				0,30		
		TL-SH20-L-100TB	25,40	60,64	20	4F	1108	59,88	66,00	9,00	28,00	31,80	10,00	22,00				0,36		
		TL-SH21-L-100TB	25,40	63,67	21	4F	1108	62,91	69,00	9,00	28,00	31,80	10,00	22,00				0,44		
		TL-SH22-L-100TB	25,40	66,70	22	4F	1108	65,94	72,00	9,00	28,00	31,80	10,00	22,00				0,51		
		TL-SH23-L-100TB	25,40	69,73	23	4F	1108	68,97	78,00	9,00	28,00	31,80	10,00	22,00				0,54		
		TL-SH24-L-100TB	25,40	72,77	24	4F	1108	72,01	78,00	9,00	28,00	31,80	10,00	22,00				0,58		
		TL-SH25-L-100TB	25,40	75,80	25	4F	1108	75,04	85,00	9,00	28,00	31,80	10,00	22,00				0,67		
		TL-SH26-L-100TB	25,40	78,83	26	4F	1108	78,07	85,00	9,00	28,00	31,80	10,00	22,00				0,72		
		TL-SH27-L-100TB	25,40	81,86	27	4F	1108	81,10	91,00	9,00	28,00	31,80	10,00	22,00				0,80		
		TL-SH28-L-100TB	25,40	84,89	28	4F	1108	84,13	91,00	9,00	28,00	31,80	10,00	22,00				0,83		
		TL-SH30-L-100TB	25,40	90,96	30	4F	1210	90,20	97,00	11,00	32,00	31,80	7,00	25,00				0,94		
		TL-SH32-L-100TB	25,40	97,02	32	4F	1210	96,26	103,00	11,00	32,00	31,80	7,00	25,00				1,10		
		TL-SH36-L-100TB	25,40	109,15	36	4F	1610	108,39	115,00	14,00	42,00	31,80	7,00	25,00				1,33		
		TL-SH40-L-100TB	25,40	121,28	40	4F	1610	120,52	127,00	14,00	42,00	31,80	7,00	25,00				1,70		
		TL-SH44-L-100TB	25,40	133,40	44	4F	1610	132,64	139,00	14,00	42,00	31,80	7,00	25,00				2,30		
		TL-SH48-L-100TB	25,40	145,53	48	13F	1610	144,77	152,00	14,00	42,00	31,80	7,00	25,00			92,00	2,60		
		TL-SH60-L-100TB	25,40	181,91	60	7N	1610	181,15		14,00	42,00	31,80	3,50	25,00	3,50	92,00		3,76		
		TL-SH72-L-100TB	25,40	218,30	72	10N	2012	217,54		14,00	50,00	31,80		32,00			111,00	4,40		
		TL-SH84-L-100TB	25,40	254,68	84	10N	2012	253,92		14,00	50,00	31,80		32,00			111,00	5,87		
		TL-SH96-L-100TB	25,40	291,06	96	10N	2012	290,30		14,00	50,00	31,80		32,00			111,00	7,26		
		TL-SH120-L-100TB	25,40	363,83	120	10N	2012	363,07		14,00	50,00	31,80		32,00			111,00	8,50		
		H	19,10	TL-SH14-H-075TB	19,10	56,60	14	2F	1108	55,23	62,00	9,00	28,00	27,00		22,00				0,48
				TL-SH15-H-075TB	19,10	60,64	15	2F	1108	59,27	67,00	9,00	28,00	27,00		22,00				0,53
				TL-SH16-H-075TB	19,10	64,67	16	2F	1108	63,30	71,00	9,00	28,00	27,00		22,00				0,57
				TL-SH17-H-075TB	19,10	68,72	17	2F	1108	67,35	75,00	9,00	32,00	27,00		22,00				0,67
TL-SH18-H-075TB	19,10			72,77	18	2F	1210	71,40	79,00	11,00	32,00	27,00		25,00				0,76		
TL-SH19-H-075TB	19,10			76,81	19	2F	1210	75,44	83,00	11,00	32,00	27,00		25,00				0,95		
TL-SH20-H-075TB	19,10			80,85	20	2F	1210	79,48	87,00	11,00	32,00	27,00		25,00				1,05		
TL-SH21-H-075TB	19,10			84,89	21	2F	1210	83,52	91,00	11,00	32,00	27,00		25,00				1,14		
TL-SH22-H-075TB	19,10			88,94	22	2F	1210	87,57	95,00	11,00	32,00	27,00		25,00				1,33		
TL-SH23-H-075TB	19,10			92,98	23	2F	1610	91,61	98,00	14,00	42,00	27,00		25,00				1,43		
TL-SH24-H-075TB	19,10			97,02	24	2F	1610	95,65	103,00	14,00	42,00	27,00		25,00				1,52		
TL-SH25-H-075TB	19,10			101,06	25	2F	1610	99,69	107,00	14,00	42,00	27,00		25,00				1,62		
TL-SH26-H-075TB	19,10			105,11	26	2F	1610	103,74	111,00	14,00	42,00	27,00		25,00				1,71		
TL-SH27-H-075TB	19,10			109,15	27	2F	1610	107,78	115,00	14,00	42,00	27,00		25,00				1,81		
TL-SH28-H-075TB	19,10			113,19	28	2F	1610	111,82	119,00	14,00	42,00	27,00		25,00				1,90		
TL-SH29-H-075TB	19,10			117,23	29	2F	1610	115,86	123,00	14,00	42,00	27,00		25,00				1,95		
TL-SH30-H-075TB	19,10			121,28	30	2F	1610	119,91	127,00	14,00	42,00	27,00		25,00				2,00		
TL-SH32-H-075TB	19,10			129,36	32	14F	1610	127,99	135,00	14,00	42,00	27,00		25,00		92,00		2,09		
TL-SH33-H-075TB	19,10			133,40	33	14F	1610	132,03	142,00	14,00	42,00	27,00		25,00		92,00		2,14		
TL-SH34-H-075TB	19,10			137,45	34	14F	1610	136,08	142,00	14,00	42,00	27,00		25,00		92,00		2,19		
TL-SH35-H-075TB	19,10			141,49	35	14F	1610	140,12	151,00	14,00	42,00	27,00		25,00		92,00		2,24		
TL-SH36-H-075TB	19,10			145,53	36	14F	1610	144,16	151,00	14,00	42,00	27,00		25,00		92,00		2,28		
TL-SH38-H-075TB	19,10			153,62	38	14F	1610	152,25	158,00	14,00	42,00	27,00		25,00		92,00		2,47		
TL-SH40-H-075TB	19,10			161,70	40	14F	1610	160,33	168,00	14,00	42,00	27,00		25,00		92,00		2,66		
TL-SH44-H-075TB	19,10			177,87	44	9F	2012	176,50	184,00	14,00	50,00	27,00	2,50	32,00	2,50	106,00		2,57		
TL-SH48-H-075TB	19,10			194,04	48	9F	2012	192,67	200,00	14,00	50,00	27,00	2,50	32,00	2,50	106,00		2,85		
TL-SH60-H-075TB	19,10	242,55	60	9N	2012	241,18		14,00	50,00	27,00	2,50	32,00	2,50	106,00		2,90				
TL-SH75-H-075TB	19,10	291,06	75	9N	2012	289,69		14,00	50,00	27,00	2,50	32,00	2,50	112,00		3,00				
TL-SH84-H-075TB	19,10	339,57	84	9N	2012	338,20		14,00	50,00	27,00	2,50	32,00	2,50	112,00		3,15				
TL-SH96-H-075TB	19,10	388,08	96	9N	2517	386,71		16,00	60,00	27,00	9,00	45,00	9,00	125,00		3,50				
TL-SH120-H-075TB	19,10	485,10	120	9N	2517	483,73		16,00	60,00	27,00	9,00	45,00	9,00	125,00		4,25				

NEXT >



PROFILE	BELT WIDTH	REFERENCE	BELT WIDTH	PITCH DIA PD	NO. TEETH	PULLEY TYPE	BUSH TYPE	OUTER DIA	A			F	K	L	M	H	WEIGHT
									mm	Min mm	Max mm						
H	25,40	TL-SH14-H-100TB	25,40	56,60	14	4F	1108	55,23	63,00	9,00	28,00	31,00	9,00	22,00			0,30
		TL-SH15-H-100TB	25,40	60,60	15	4F	1108	59,23	67,00	9,00	28,00	31,00	9,00	22,00			0,40
		TL-SH16-H-100TB	25,40	64,70	16	4F	1108	63,33	71,00	9,00	28,00	31,00	9,00	22,00			0,40
		TL-SH17-H-100TB	25,40	68,70	17	4F	1108	67,33	75,00	9,00	28,00	31,00	9,00	22,00			0,50
		TL-SH18-H-100TB	25,40	72,80	18	4F	1210	71,43	79,00	11,00	32,00	31,00	6,00	25,00			0,50
		TL-SH19-H-100TB	25,40	76,80	19	4F	1210	75,43	83,00	11,00	32,00	31,00	6,00	25,00			0,60
		TL-SH20-H-100TB	25,40	80,80	20	4F	1210	79,43	87,00	11,00	32,00	31,00	6,00	25,00			0,80
		TL-SH21-H-100TB	25,40	84,90	21	4F	1210	83,53	91,00	11,00	32,00	32,00	7,00	25,00			0,80
		TL-SH22-H-100TB	25,40	88,90	22	4F	1210	87,53	95,00	11,00	32,00	32,00	7,00	25,00			0,90
		TL-SH23-H-100TB	25,40	93,00	23	4F	1610	91,63	98,00	14,00	42,00	32,00	7,00	25,00			0,90
		TL-SH24-H-100TB	25,40	97,00	24	4F	1610	95,63	103,00	14,00	42,00	32,00	7,00	25,00			1,00
		TL-SH25-H-100TB	25,40	101,10	25	4F	1610	99,73	107,00	14,00	42,00	32,00	7,00	25,00			1,10
		TL-SH26-H-100TB	25,40	105,10	26	4F	1610	103,73	111,00	14,00	42,00	32,00	7,00	25,00			1,20
		TL-SH27-H-100TB	25,40	109,20	27	4F	1610	107,83	115,00	14,00	42,00	32,00	7,00	25,00			1,4
		TL-SH28-H-100TB	25,40	113,20	28	4F	1610	111,83	119,00	14,00	42,00	32,00	7,00	25,00			1,50
		TL-SH30-H-100TB	25,40	121,30	30	4F	1610	119,93	127,00	14,00	42,00	32,00	7,00	25,00			1,70
		TL-SH32-H-100TB	25,40	129,40	32	13F	1610	128,03	135,00	14,00	42,00	32,00	7,00	25,00	92,00		1,70
		TL-SH36-H-100TB	25,40	145,50	36	13F	1610	144,13	151,00	14,00	42,00	32,00	7,00	25,00	92,00		2,30
		TL-SH40-H-100TB	25,40	161,70	40	13F	1610	160,33	168,00	14,00	42,00	32,00	7,00	25,00	92,00		2,70
		TL-SH44-H-100TB	25,40	177,90	44	14F	2012	176,53	184,00	14,00	50,00	32,00	7,00	32,00	106,00		3,70
		TL-SH48-H-100TB	25,40	194,00	48	14F	2012	192,63	200,00	14,00	50,00	32,00	7,00	32,00	106,00		4,70
		TL-SH60-H-100TB	25,40	242,60	60	8N	2012	241,23		14,00	50,00	34,00	1,00	32,00	1,00	106,00	7,50
		TL-SH75-H-100TB	25,40	291,10	72	8N	2012	289,73		14,00	50,00	34,00	1,00	32,00	1,00	106,00	8,40
		TL-SH84-H-100TB	25,40	339,60	84	8N	2012	338,23		14,00	50,00	34,00	1,00	32,00	1,00	106,00	9,00
		TL-SH96-H-100TB	25,40	388,10	96	9N	2517	386,73		16,00	60,00	34,00	5,50	45,00	5,50	124,00	11,00
		TL-SH120-H-100TB	25,40	485,10	120	9N	2517	483,73		16,00	60,00	34,00	5,50	45,00	5,50	124,00	14,00
H	38,10	TL-SH14-H-150TB	38,10	56,60	14	4F	1108	55,23	63,00	9,00	28,00	45,00	23,00	22,00			0,50
		TL-SH16-H-150TB	38,10	64,67	16	4F	1108	63,30	71,00	9,00	28,00	45,00	23,00	22,00			0,60
		TL-SH18-H-150TB	38,10	72,77	18	4F	1210	71,40	79,00	11,00	32,00	45,00	20,00	25,00			0,69
		TL-SH19-H-150TB	38,10	76,81	19	4F	1210	75,44	83,00	11,00	32,00	45,00	20,00	25,00			0,86
		TL-SH20-H-150TB	38,10	80,85	20	4F	1210	79,48	87,00	11,00	32,00	45,00	20,00	25,00			0,98
		TL-SH21-H-150TB	38,10	84,89	21	4F	1210	83,52	91,00	11,00	32,00	45,00	20,00	25,00			0,98

NEXT >

TYPE 2F

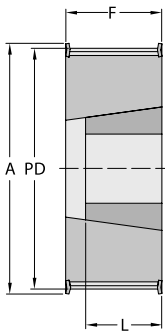

TYPE 4F

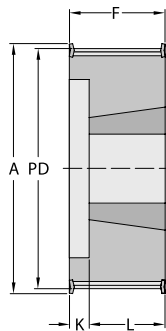

TYPE 7N

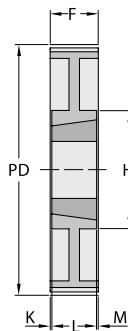

TYPE 8N

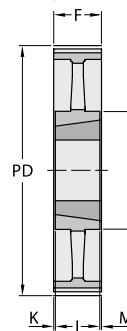

TYPE 9N

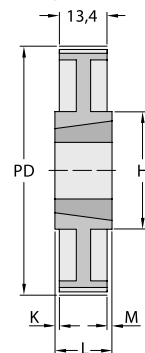

TYPE 9F

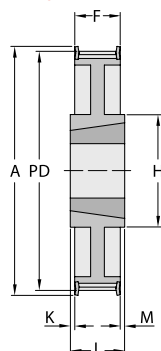

TYPE 10N

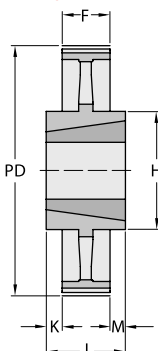

TYPE 13F

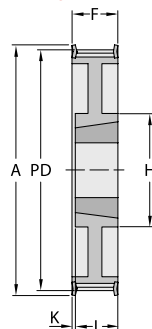

TYPE 14F

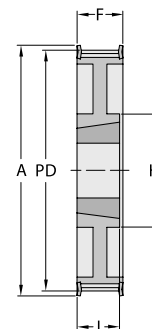

PROFILE	BELT WIDTH	REFERENCE	BELT WIDTH	PITCH DIA PD	NO. TEETH	PULLEY TYPE	BUSH TYPE	OUTER DIA	A	BORE		F	K	L	M	H	WEIGHT		
									mm	Min mm	Max mm	mm	mm	mm	mm	mm		mm	Kg
H	38,10	TL-SH22-H-150TB	38,10	88,94	22	4F	1210	87,57	95,00	11,00	32,00	45,00	20,00	25,00			1,10		
		TL-SH23-H-150TB	38,10	92,98	23	4F	1610	91,61	98,00	14,00	42,00	45,00	20,00	25,00			1,16		
		TL-SH24-H-150TB	38,10	97,02	24	4F	1610	95,65	103,00	14,00	42,00	45,00	20,00	25,00			1,22		
		TL-SH25-H-150TB	38,10	101,06	25	4F	1610	99,69	107,00	14,00	42,00	45,00	20,00	25,00			1,37		
		TL-SH26-H-150TB	38,10	105,11	26	4F	1610	103,74	111,00	14,00	42,00	45,00	20,00	25,00			1,51		
		TL-SH27-H-150TB	38,10	109,15	27	4F	1610	107,78	115,00	14,00	42,00	45,00	20,00	25,00			1,67		
		TL-SH28-H-150TB	38,10	113,19	28	4F	1610	111,82	119,00	14,00	42,00	45,00	20,00	25,00			1,77		
		TL-SH30-H-150TB	38,10	121,28	30	4F	1610	119,91	127,00	14,00	42,00	45,00	20,00	25,00			2,05		
		TL-SH32-H-150TB	38,10	129,36	32	13F	1610	127,99	135,00	14,00	42,00	45,00	20,00	25,00		92,00	2,07		
		TL-SH36-H-150TB	38,10	145,53	36	13F	1610	144,16	151,00	14,00	42,00	45,00	20,00	25,00		92,00	2,76		
		TL-SH40-H-150TB	38,10	161,70	40	13F	1610	160,33	168,00	14,00	42,00	45,00	20,00	25,00		92,00	3,34		
		TL-SH44-H-150TB	38,10	177,87	44	13F	2012	176,50	184,00	14,00	50,00	45,00	13,00	32,00		106,00	5,19		
		TL-SH48-H-150TB	38,10	194,34	48	13F	2012	192,97	200,00	14,00	50,00	45,00	13,00	32,00		106,00	5,70		
		TL-SH60-H-150TB	38,10	242,55	60	8N	2012	241,18		14,00	50,00	46,00	7,00	32,00	7,00	106,00	6,81		
		TL-SH72-H-150TB	38,10	291,06	72	8N	2012	289,69		14,00	50,00	46,00	7,00	32,00	7,00	106,00	7,79		
		TL-SH84-H-150TB	38,10	339,57	84	8N	2012	338,20		14,00	50,00	46,00	7,00	32,00	7,00	111,00	9,15		
		TL-SH96-H-150TB	38,10	388,08	96	8N	2517	386,71		16,00	60,00	46,00	0,50	45,00	0,50	124,00	13,00		
		TL-SH120-H-150TB	38,10	485,10	120	8N	2517	483,73		16,00	60,00	46,00	0,50	45,00	0,50	124,00	16,80		
		H	50,80	TL-SH16-H-200TB	50,80	64,57	16	4F	1108	63,20	71,00	9,00	28,00	58,00	36,00	22,00			0,80
				TL-SH18-H-200TB	50,80	72,77	18	4F	1210	71,40	79,00	11,00	32,00	58,00	33,00	25,00			0,91
TL-SH19-H-200TB	50,80			76,81	19	4F	1210	75,44	83,00	11,00	32,00	58,00	33,00	25,00			1,05		
TL-SH20-H-200TB	50,80			80,85	20	4F	1610	79,48	87,00	14,00	42,00	58,00	33,00	25,00			0,92		
TL-SH21-H-200TB	50,80			84,89	21	4F	1610	83,52	91,00	14,00	42,00	58,00	33,00	25,00			1,04		
TL-SH22-H-200TB	50,80			88,94	22	4F	1610	87,57	95,00	14,00	42,00	58,00	33,00	25,00			1,18		
TL-SH23-H-200TB	50,80			92,98	23	4F	1610	91,61	98,00	14,00	42,00	58,00	33,00	25,00			1,28		
TL-SH24-H-200TB	50,80			97,02	24	4F	1610	95,65	103,00	14,00	42,00	58,00	33,00	25,00			1,37		
TL-SH25-H-200TB	50,80			101,06	25	4F	1610	99,69	107,00	14,00	42,00	58,00	33,00	25,00			1,59		
TL-SH26-H-200TB	50,80			105,11	26	4F	1610	103,74	111,00	14,00	42,00	58,00	33,00	25,00			1,63		
TL-SH27-H-200TB	50,80			109,15	27	4F	1610	107,78	115,00	14,00	42,00	58,00	33,00	25,00			1,98		
TL-SH28-H-200TB	50,80			113,19	28	4F	1610	111,82	119,00	14,00	42,00	58,00	33,00	25,00			1,92		
TL-SH30-H-200TB	50,80			121,28	30	4F	1610	119,91	127,00	14,00	42,00	58,00	33,00	25,00			2,24		
TL-SH32-H-200TB	50,80			129,36	32	4F	2012	127,99	135,00	14,00	50,00	58,00	26,00	32,00			2,87		
TL-SH36-H-200TB	50,80			145,53	36	13F	2012	144,16	151,00	14,00	50,00	58,00	26,00	32,00			3,42		
TL-SH40-H-200TB	50,80			161,70	40	13F	2012	160,33	168,00	14,00	50,00	58,00	26,00	32,00			4,39		
TL-SH44-H-200TB	50,80			177,87	44	13F	2012	176,50	184,00	14,00	50,00	58,00	26,00	32,00			5,89		
TL-SH48-H-200TB	50,80			194,04	48	13F	2517	192,67	200,00	16,00	60,00	58,00	13,00	45,00			7,00		
TL-SH60-H-200TB	50,80			242,55	60	8N	2517	241,18		16,00	60,00	60,00	7,50	45,00	7,50		8,88		
TL-SH72-H-200TB	50,80			291,06	72	8N	2517	289,69		16,00	60,00	60,00	7,50	45,00	7,50		9,05		
TL-SH84-H-200TB	50,80	339,57	84	8N	2517	338,20		16,00	60,00	60,00	7,50	45,00	7,50		10,66				
TL-SH96-H-200TB	50,80	388,08	96	8N	2517	386,71		16,00	60,00	60,00	7,50	45,00	7,50		15,28				
TL-SH120-H-200TB	50,80	485,10	120	8N	2517	483,73		16,00	60,00	60,00	7,50	45,00	7,50		20,16				
H	76,20	TL-SH18-H-300TB	76,20	72,77	18	6F	1215	71,40	83,00	11,00	32,00	84,00	23,00	38,00	23,00		1,10		
		TL-SH20-H-300TB	76,20	80,85	20	6F	1615	79,48	87,00	14,00	42,00	84,00	23,00	38,00	23,00		1,25		
		TL-SH21-H-300TB	76,20	84,89	21	6F	1615	83,52	91,00	14,00	42,00	84,00	23,00	38,00	23,00		1,56		
		TL-SH22-H-300TB	76,20	88,94	22	6F	1615	87,57	94,00	14,00	42,00	84,00	23,00	38,00	23,00		1,75		
		TL-SH23-H-300TB	76,20	92,98	23	6F	1615	91,61	98,00	14,00	42,00	84,00	23,00	38,00	23,00		1,93		
		TL-SH24-H-300TB	76,20	97,02	24	6F	1615	95,65	103,00	14,00	42,00	84,00	23,00	38,00	23,00		2,14		
		TL-SH25-H-300TB	76,20	101,06	25	6F	1615	99,69	107,00	14,00	42,00	84,00	23,00	38,00	23,00		2,21		
		TL-SH26-H-300TB	76,20	105,11	26	6F	1615	103,74	111,00	14,00	42,00	84,00	23,00	38,00	23,00		2,65		
		TL-SH27-H-300TB	76,20	109,15	27	6F	2012	107,78	115,00	14,00	50,00	84,00	26,00	32,00	26,00		2,49		
		TL-SH28-H-300TB	76,20	113,19	28	6F	2012	111,82	119,00	14,00	50,00	84,00	26,00	32,00	26,00		2,88		
		TL-SH30-H-300TB	76,20	121,28	30	6F	2012	119,91	127,00	14,00	50,00	84,00	26,00	32,00	26,00		3,44		
		TL-SH32-H-300TB	76,20	129,36	32	6F	2517	127,99	135,00	16,00	60,00	84,00	19,50	45,00	19,50		3,51		
		TL-SH36-H-300TB	76,20	145,53	36	6F	2517	144,16	151,00	16,00	60,00	84,00	19,50	45,00	19,50		4,43		
		TL-SH40-H-300TB	76,20	161,70	40	6F	2517	160,33	168,00	16,00	60,00	84,00	19,50	45,00	19,50		6,10		
TL-SH44-H-300TB	76,20	177,87	44	7F	2517	176,50	184,00	16,00	60,00	86,00	20,50	45,00	20,50	124,00	7,55				

NEXT >



PROFILE	BELT WIDTH	REFERENCE	BELT WIDTH	PITCH DIA PD	NO. TEETH	PULLEY TYPE	BUSH TYPE	OUTER DIA	A		BORE		F	K	L	M	H	WEIGHT		
									mm	mm	Min mm	Max mm								
		TL-SH48-H-300TB	76,20	194,04	48	7F	2517	192,67	200,00	16,00	60,00	86,00	20,50	45,00	20,50	124,00	8,99			
		TL-SH60-H-300TB	76,20	242,55	60	8N	2517	241,18		16,00	60,00	86,00	20,50	45,00	20,50	124,00	11,06			
		TL-SH72-H-300TB	76,20	291,06	72	8N	2517	289,69		16,00	60,00	86,00	20,50	45,00	20,50	124,00	12,66			
		TL-SH84-H-300TB	76,20	339,57	84	8N	2517	338,20		16,00	60,00	86,00	20,50	45,00	20,50	124,00	14,50			
		TL-SH96-H-300TB	76,20	388,08	96	8N	3030	386,71		35,00	75,00	86,00	5,00	76,00	5,00	155,00	16,2			
		TL-SH120-H-300TB	76,20	485,10	120	8N	3030	483,73		35,00	75,00	86,00	5,00	76,00	5,00	155,00	20,8			
XH	50,80	TL-SH18-XH-200TB	50,80	127,34	18	6F	2012	124,54	141,00	14,00	50,00	65,10		32,00				2,60		
		TL-SH19-XH-200TB	50,80	134,41	19	6F	2012	131,61	146,00	14,00	50,00	65,10		32,00				3,10		
		TL-SH20-XH-200TB	50,80	141,19	20	6F	2012	138,69	155,00	14,00	50,00	65,10		32,00				3,60		
		TL-SH21-XH-200TB	50,80	148,56	21	6F	2517	145,76	169,00	16,00	60,00	65,10		45,00				4,20		
		TL-SH22-XH-200TB	50,80	155,64	22	6F	2517	152,84	169,00	16,00	60,00	65,10		45,00				4,80		
		TL-SH24-XH-200TB	50,80	169,79	24	6F	2517	166,99	183,00	16,00	60,00	65,10		45,00				6,10		
		TL-SH25-XH-200TB	50,80	176,86	25	6F	2517	174,06	198,00	16,00	60,00	65,10		45,00				6,80		
		TL-SH26-XH-200TB	50,80	183,93	26	6F	2517	181,13	198,00	16,00	60,00	65,10		45,00				7,40		
		TL-SH27-XH-200TB	50,80	191,01	27	7F	2517	188,21	212,00	16,00	60,00	65,10		45,00			134,00	8,20		
		TL-SH28-XH-200TB	50,80	198,09	28	7F	2517	195,29	212,00	16,00	60,00	65,10		45,00			134,00	9,00		
		TL-SH30-XH-200TB	50,80	212,23	30	7F	2517	209,43	226,00	16,00	60,00	65,10		45,00			134,00	9,6		
		TL-SH32-XH-200TB	50,80	226,38	32	7F	2517	223,58	240,00	16,00	60,00	65,10		45,00			134,00	9,80		
		TL-SH36-XH-200TB	50,80	254,64	36	8F	2517	251,84	267,00	16,00	60,00	65,10		45,00			134,00	11,60		
		TL-SH40-XH-200TB	50,80	282,98	40	8N	2517	280,18		16,00	60,00	65,10		45,00			134,00	13,30		
		TL-SH48-XH-200TB	50,80	339,57	48	8N	3020	336,77		25,00	75,00	65,10		51,00			165,00	19,00		
		TL-SH60-XH-200TB	50,80	424,47	60	8N	3020	421,67		25,00	75,00	65,10		51,00			165,00	22,00		
		XH	76,20	TL-SH18-XH-300TB	76,20	127,34	18	6F	2012	124,54	141,00	14,00	50,00	92,10		45,00				3,70
				TL-SH19-XH-300TB	76,20	134,41	19	6F	2517	131,61	146,00	16,00	60,00	92,10		45,00				4,20
TL-SH20-XH-300TB	76,20			141,19	20	6F	2517	138,69	155,00	16,00	60,00	92,10		45,00				4,70		
TL-SH21-XH-300TB	76,20			148,56	21	6F	2517	145,76	169,00	16,00	60,00	92,10		45,00				5,40		
TL-SH22-XH-300TB	76,20			155,64	22	6F	2517	152,84	169,00	16,00	60,00	92,10		45,00				6,00		
TL-SH24-XH-300TB	76,20			169,79	24	6F	2517	166,99	183,00	16,00	60,00	92,10		45,00				7,60		
TL-SH25-XH-300TB	76,20			176,86	25	6F	2517	174,06	198,00	16,00	60,00	92,10		45,00				8,70		
TL-SH26-XH-300TB	76,20			183,93	26	6F	2517	181,13	198,00	16,00	60,00	92,10		45,00				9,80		
TL-SH27-XH-300TB	76,20			191,01	27	6F	2517	188,21	212,00	16,00	60,00	92,10		45,00				10,70		
TL-SH28-XH-300TB	76,20			198,09	28	7F	2517	195,29	212,00	16,00	60,00	92,10		45,00			134,00	11,60		
TL-SH30-XH-300TB	76,20			212,23	30	7F	2517	209,43	226,00	16,00	60,00	92,10		45,00			134,00	11,9		
TL-SH32-XH-300TB	76,20			226,38	32	7F	3020	223,58	240,00	25,00	75,00	92,10		51,00			165,00	13,80		
TL-SH36-XH-300TB	76,20			254,64	36	7F	3020	251,84	267,00	25,00	75,00	92,10		51,00			165,00	16,70		
TL-SH40-XH-300TB	76,20			282,98	40	8N	3020	280,18		25,00	75,00	92,10		51,00			165,00	19,50		
TL-SH48-XH-300TB	76,20			339,57	48	8N	3020	336,77		25,00	75,00	92,10		51,00			165,00	27,00		
TL-SH60-XH-300TB	76,20			424,47	60	8N	3535	421,67		35,00	90,00	92,10		89,00			184,00	28,00		
XH	101,60			TL-SH18-XH-400TB	76,20	127,34	18	6F	2012	124,54	141,00	16,00	60,00	92,10		45,00				5,00
				TL-SH19-XH-400TB	76,20	134,41	19	6F	2517	131,61	146,00	16,00	60,00	92,10		45,00				5,50
		TL-SH20-XH-400TB	76,20	141,19	20	6F	2517	138,69	155,00	16,00	60,00	92,10		45,00				6,00		
		TL-SH21-XH-400TB	76,20	148,56	21	6F	2517	145,76	169,00	16,00	60,00	92,10		45,00				6,60		

NEXT >

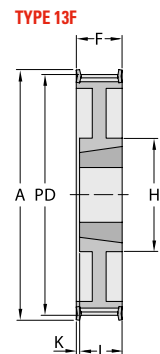
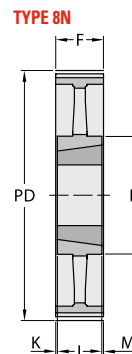
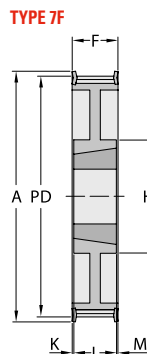
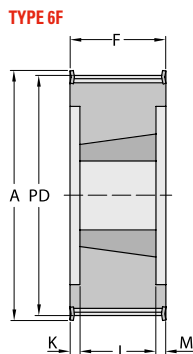
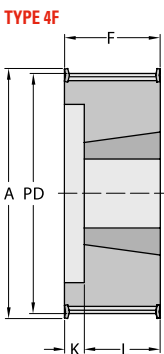

PROFILE	BELT WIDTH	REFERENCE	BELT WIDTH	PITCH DIA PD	NO. TEETH	PULLEY TYPE	BUSH TYPE	OUTER DIA	A		BORE		F	K	L	M	H	WEIGHT
									mm	Min mm	Max mm	mm						
XH	101,60	TL-SH22-XH-400TB	76,20	155,64	22	6F	2517	152,84	169,00	16,00	60,00	92,10		45,00				7,20
		TL-SH24-XH-400TB	76,20	169,79	24	6F	3020	166,99	183,00	25,00	75,00	92,10		51,00				8,40
		TL-SH25-XH-400TB	76,20	176,86	25	6F	3020	174,06	198,00	25,00	75,00	92,10		51,00				9,40
		TL-SH26-XH-400TB	76,20	183,93	26	6F	3020	181,13	198,00	25,00	75,00	92,10		51,00				10,30
		TL-SH27-XH-400TB	76,20	191,01	27	6F	3020	188,21	212,00	25,00	75,00	92,10		51,00				11,30
		TL-SH28-XH-400TB	76,20	198,09	28	6F	3020	195,29	212,00	25,00	75,00	92,10		51,00				12,30
		TL-SH30-XH-400TB	76,20	212,23	30	6F	3020	209,43	226,00	25,00	75,00	92,10		51,00				14,30
		TL-SH32-XH-400TB	76,20	226,38	32	7F	3020	223,58	240,00	25,00	75,00	92,10		51,00			165,00	19,90
		TL-SH36-XH-400TB	76,20	254,64	36	7F	3020	251,84	267,00	25,00	75,00	92,10		51,00			165,00	22,30
		TL-SH40-XH-400TB	76,20	282,98	40	8N	3020	280,18		25,00	75,00	92,10		51,00			165,00	24,60
		TL-SH48-XH-400TB	76,20	339,57	48	8N	3535	336,77		35,00	90,00	92,10		89,00			184,00	30,00
		TL-SH60-XH-400TB	76,20	424,47	60	8N	3535	421,67		35,00	90,00	92,10		89,00			184,00	40,00

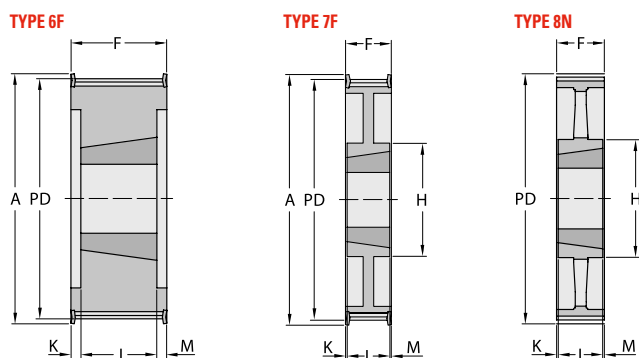

NOMENCLATOR

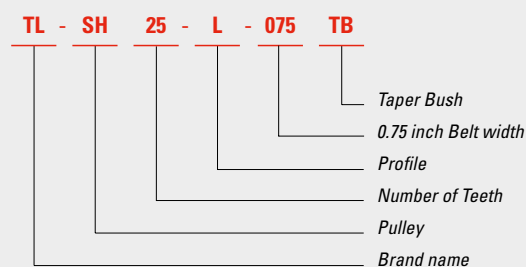

TIMING PULLEYS. PROFILE HTD® 3M, 5M, 8M, 14M. RSB

PROFILE	PITCH	BELT WIDTH
		mm
3M	3,00	9,00
		15,00
5M	5,00	9,00
		15,00
		20,00
8M	8,00	30,00
		50,00
		85,00
		40,00
14M	14,00	55,00
		85,00
		115,00
		170,00

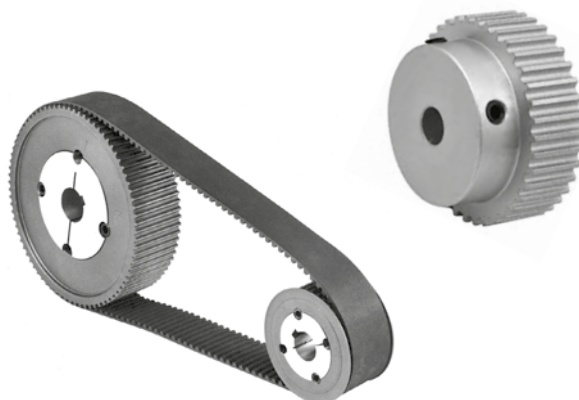

Reference nomenclature: An alphanumeric string with blocks designating the product family SH, the number of teeth, the belt section matching the Timing Pulley profile, the width expressed in mm, the fixing mode of the pulley to shaft and finally a block indicating an specific requirement if any.

PROFILE HTD® 3M, 5M, 8M, 14M. RSB

PROFILE	BELT WIDTH	REFERENCE	PITCH	BELT WIDTH	PITCH DIA PD	NO. TEETH	PULLEY TYPE	OUTER DIA	BORE			F	K	L	M	H	WEIGHT
									A	Min mm	Max mm						
3M	09	TL-SH10-3M-09RSB	3,00	9,00	9,55	10	OF	8,79	13,00		4,00	10,20		17,50		13,00	0,04
		TL-SH12-3M-09RSB	3,00	9,00	11,46	12	OF	10,70	15,00		6,00	10,20		17,50		15,00	0,06
		TL-SH14-3M-09RSB	3,00	9,00	13,37	14	OF	12,61	16,00		7,00	10,20		17,50		16,00	0,07
		TL-SH15-3M-09RSB	3,00	9,00	14,32	15	OF	13,56	17,50		8,00	10,20		17,50		17,00	0,08
		TL-SH16-3M-09RSB	3,00	9,00	15,28	16	1F	14,52	18,00	4,00	6,00	12,80		20,60		10,00	0,07
		TL-SH18-3M-09RSB	3,00	9,00	17,19	18	1F	16,43	19,50	6,00	6,50	12,80		20,60		11,00	0,08
		TL-SH20-3M-09RSB	3,00	9,00	19,10	20	1F	18,34	23,00	6,00	8,00	12,80		20,60		13,00	0,01
		TL-SH21-3M-09RSB	3,00	9,00	20,05	21	1F	19,29	25,00	6,00	8,50	12,80		20,60		14,00	0,01
		TL-SH22-3M-09RSB	3,00	9,00	21,01	22	1F	20,25	25,00	6,00	8,50	12,80		20,60		14,00	0,01
		TL-SH24-3M-09RSB	3,00	9,00	22,92	24	1F	22,16	25,00	6,00	8,50	12,80		20,60		14,00	0,02
		TL-SH26-3M-09RSB	3,00	9,00	24,83	26	1F	24,07	28,00	6,00	10,50	12,80		20,60		16,00	0,02
		TL-SH28-3M-09RSB	3,00	9,00	26,74	28	1F	25,98	32,00	6,00	11,50	12,80		20,60		18,00	0,02
		TL-SH30-3M-09RSB	3,00	9,00	28,65	30	1F	27,89	32,00	6,00	12,50	12,80		20,60		20,00	0,03
		TL-SH32-3M-09RSB	3,00	9,00	30,56	32	1F	29,80	36,00	6,00	14,00	12,80		20,60		22,00	0,03
		TL-SH36-3M-09RSB	3,00	9,00	34,38	36	1F	33,62	38,00	6,00	17,00	13,40		22,20		26,00	0,05
		TL-SH40-3M-09RSB	3,00	9,00	38,20	40	1F	37,44	42,00	6,00	19,00	13,40		22,20		28,00	0,06
		TL-SH44-3M-09RSB	3,00	9,00	42,02	44	1F	41,26	48,00	6,00	22,50	13,40		22,20		33,00	0,07
		TL-SH48-3M-09RSB	3,00	9,00	45,84	48	1N	45,08		8,00	22,50	13,40		22,20		33,00	0,07
		TL-SH60-3M-09RSB	3,00	9,00	57,30	60	1N	56,54		8,00	22,50	13,40		22,20		33,00	0,11
		TL-SH72-3M-09RSB	3,00	9,00	68,75	72	1N	67,99		8,00	22,50	13,40		22,20		33,00	0,14
3M	15	TL-SH10-3M-15RSB	3,00	15,00	9,55	10	OF	8,79	13,00		3,00	17,00		26,00		13,00	0,04
		TL-SH12-3M-15RSB	3,00	15,00	11,46	12	OF	10,70	15,00		5,00	17,00		26,00		15,00	0,06
		TL-SH14-3M-15RSB	3,00	15,00	13,37	14	OF	12,61	16,00		6,00	17,00		26,00		16,00	0,07
		TL-SH15-3M-15RSB	3,00	15,00	14,32	15	OF	13,56	17,50		6,00	17,00		26,00		17,50	0,08
		TL-SH16-3M-15RSB	3,00	15,00	15,28	16	1F	14,52	18,00	4,00	7,00	19,50		26,00		10,00	0,07
		TL-SH18-3M-15RSB	3,00	15,00	17,19	18	1F	16,43	19,50	6,00	8,00	19,50		26,00		11,00	0,08
		TL-SH20-3M-15RSB	3,00	15,00	19,10	20	1F	18,34	23,00	6,00	9,00	19,50		26,00		13,00	0,01
		TL-SH21-3M-15RSB	3,00	15,00	20,05	21	1F	19,29	25,00	6,00	9,00			26,00		14,00	0,01
		TL-SH22-3M-15RSB	3,00	15,00	21,01	22	1F	20,25	25,00	6,00	9,00	19,50		26,00		14,00	0,01
		TL-SH24-3M-15RSB	3,00	15,00	22,92	24	1F	22,16	25,00	6,00	9,00	19,50		26,00		14,00	0,02
		TL-SH26-3M-15RSB	3,00	15,00	24,83	26	1F	24,07	28,00	6,00	11,00	19,50		26,00		16,00	0,02
		TL-SH28-3M-15RSB	3,00	15,00	26,73	28	1F	25,98	32,00	6,00	12,00	19,50		26,00		18,00	0,02
		TL-SH30-3M-15RSB	3,00	15,00	28,65	30	1F	27,89	32,00	6,00	14,00	19,50		26,00		20,00	0,03
		TL-SH32-3M-15RSB	3,00	15,00	30,56	32	1F	29,80	37,00	6,00	15,00	19,50		26,00		22,00	0,03
		TL-SH36-3M-15RSB	3,00	15,00	34,38	36	1F	33,62	38,00	6,00	16,00	20,00		30,00		26,00	0,05
		TL-SH40-3M-15RSB	3,00	15,00	38,20	40	1F	37,44	43,00	6,00	18,00	20,00		30,00		28,00	0,06
		TL-SH44-3M-15RSB	3,00	15,00	42,02	44	1F	41,26	48,00	6,00	20,00	20,00		30,00		33,00	0,07
		TL-SH48-3M-15RSB	3,00	15,00	45,84	48	1N	45,08		8,00	20,00	20,00		30,00		33,00	0,07
		TL-SH60-3M-15RSB	3,00	15,00	57,30	60	1N	56,54		8,00	20,00	20,00		30,00		33,00	0,11
		TL-SH72-3M-15RSB	3,00	15,00	68,75	72	1N	67,99		8,00	20,00	20,00		30,00		33,00	0,14

NEXT >

TYPE OF

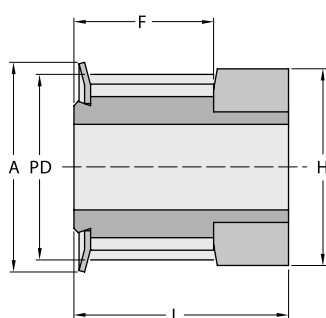

TYPE 1N

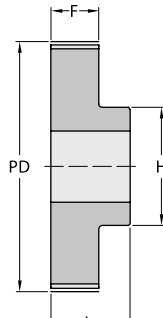

TYPE 1F

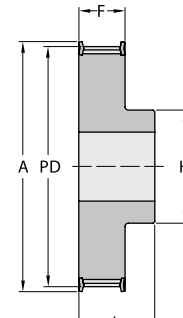

PROFILE	BELT WIDTH	REFERENCE	PITCH	BELT WIDTH	PITCH DIA PD	NO. TEETH	PULLEY TYPE	OUTER DIA	A		BORE		F	K	L	M	H	WEIGHT
									mm	Min mm	Max mm	mm						
5M	09	TL-SH12-5M-09RSB	5,00	9,00	19,10	12	1F	17,96	25,00	4,00	8,00	14,50			20,00		13,00	0,03
		TL-SH14-5M-09RSB	5,00	9,00	22,28	14	1F	21,14	25,00	6,00	9,00	14,50			20,00		13,00	0,03
		TL-SH15-5M-09RSB	5,00	9,00	23,87	15	1F	22,73	28,00	6,00	11,00	14,50			20,00		16,00	0,04
		TL-SH16-5M-09RSB	5,00	9,00	25,46	16	1F	24,32	28,00	6,00	11,00	14,50			20,00		16,00	0,05
		TL-SH18-5M-09RSB	5,00	9,00	28,65	18	1F	27,51	32,00	6,00	13,00	14,50			20,00		19,00	0,07
		TL-SH20-5M-09RSB	5,00	9,00	31,83	20	1F	30,69	36,00	6,00	14,00	14,50			22,50		23,00	0,09
		TL-SH21-5M-09RSB	5,00	9,00	33,42	21	1F	32,28	38,00	6,00	15,00	14,50			22,50		24,00	0,11
		TL-SH22-5M-09RSB	5,00	9,00	35,01	22	1F	33,87	38,00	6,00	16,00	14,50			22,50		25,50	0,12
		TL-SH24-5M-09RSB	5,00	9,00	38,20	24	1F	37,06	42,00	6,00	18,00	14,50			22,50		27,00	0,15
		TL-SH26-5M-09RSB	5,00	9,00	41,38	26	1F	40,24	44,00	6,00	20,00	14,50			22,50		30,00	0,17
		TL-SH28-5M-09RSB	5,00	9,00	44,56	28	1F	43,42	48,00	6,00	20,00	14,50			22,50		30,50	0,20
		TL-SH30-5M-09RSB	5,00	9,00	47,75	30	1F	46,60	51,00	6,00	24,00	14,50			22,50		35,00	0,24
		TL-SH32-5M-09RSB	5,00	9,00	50,93	32	1F	49,79	54,00	8,00	26,00	14,50			22,50		38,00	0,27
		TL-SH36-5M-09RSB	5,00	9,00	57,30	36	1F	56,16	60,00	8,00	26,00	14,50			22,50		38,00	0,32
		TL-SH40-5M-09RSB	5,00	9,00	63,66	40	1F	62,52	71,00	8,00	26,00	14,50			22,50		38,00	0,40
		TL-SH44-5M-09RSB	5,00	9,00	70,03	44	2N	68,89		8,00	26,00	14,50			25,50		38,00	0,17
		TL-SH48-5M-09RSB	5,00	9,00	76,39	48	2N	75,25		8,00	26,00	14,50			25,50		38,00	0,18
		TL-SH60-5M-09RSB	5,00	9,00	95,49	60	2N	94,35		8,00	30,00	14,50			25,50		45,00	0,23
		TL-SH72-5M-09RSB	5,00	9,00	114,59	72	2N	113,45		8,00	30,00	14,50			25,50		45,00	0,27
		5M	15	TL-SH12-5M-15RSB	5,00	15,00	19,10	12	1F	17,96	25,00	4,00	8,00	20,50		26,00		13,00
TL-SH14-5M-15RSB	5,00			15,00	22,28	14	1F	21,14	25,00	6,00	9,00	20,50		26,00		13,00	0,05	
TL-SH15-5M-15RSB	5,00			15,00	23,87	15	1F	22,73	28,00	6,00	11,00	20,50		26,00		16,00	0,06	
TL-SH16-5M-15RSB	5,00			15,00	25,46	16	1F	24,32	28,00	6,00	11,00	20,50		26,00		16,00	0,06	
TL-SH18-5M-15RSB	5,00			15,00	28,65	18	1F	27,51	32,00	6,00	13,00	20,50		26,00		19,00	0,09	
TL-SH20-5M-15RSB	5,00			15,00	31,83	20	1F	30,69	36,00	6,00	14,00	20,50		26,00		23,00	0,11	
TL-SH21-5M-15RSB	5,00			15,00	33,42	21	1F	32,28	38,00	6,00	15,00	20,50		26,00		24,00	0,13	
TL-SH22-5M-15RSB	5,00			15,00	35,01	22	1F	33,87	38,00	6,00	16,00	20,50		26,00		25,50	0,14	
TL-SH24-5M-15RSB	5,00			15,00	38,20	24	1F	37,06	42,00	6,00	18,00	20,50		28,00		27,00	0,18	
TL-SH26-5M-15RSB	5,00			15,00	41,38	26	1F	40,24	44,00	6,00	20,00	20,50		28,00		30,00	0,22	
TL-SH28-5M-15RSB	5,00			15,00	44,56	28	1F	43,42	48,00	6,00	20,00	20,50		28,00		30,50	0,25	
TL-SH30-5M-15RSB	5,00			15,00	47,75	30	1F	46,60	51,00	6,00	24,00	20,50		28,00		35,00	0,30	
TL-SH32-5M-15RSB	5,00			15,00	50,93	32	1F	49,79	54,00	8,00	26,00	20,50		28,00		38,00	0,35	
TL-SH36-5M-15RSB	5,00			15,00	57,30	36	1F	56,16	60,00	8,00	26,00	20,50		28,00		38,00	0,52	
TL-SH40-5M-15RSB	5,00			15,00	63,66	40	1F	62,52	71,00	8,00	26,00	20,50		28,00		38,00	0,43	
TL-SH44-5M-15RSB	5,00			15,00	70,03	44	2N	68,89		8,00	26,00	20,50		30,00		38,00	0,23	
TL-SH48-5M-15RSB	5,00			15,00	76,39	48	2N	75,25		8,00	26,00	20,50		30,00		38,00	0,19	
TL-SH60-5M-15RSB	5,00			15,00	95,49	60	2N	94,35		8,00	34,00	20,50		30,00		50,00	0,31	
TL-SH72-5M-15RSB	5,00			15,00	114,59	72	2N	113,45		8,00	34,00	20,50		30,00		50,00	0,38	
5M	25			TL-SH12-5M-25RSB	5,00	25,00	19,10	12	1F	17,96	25,00	4,00	8,00	30,50		36,00	5,50	13,00
		TL-SH14-5M-25RSB	5,00	25,00	22,28	14	1F	21,14	25,00	6,00	9,00	30,50		36,00	5,50	13,00	0,07	
		TL-SH15-5M-25RSB	5,00	25,00	23,87	15	1F	22,73	28,00	6,00	11,00	30,50		36,00	5,50	16,00	0,08	
		TL-SH16-5M-25RSB	5,00	25,00	25,46	16	1F	24,32	28,00	6,00	11,00	30,50		36,00	5,50	16,00	0,10	
		TL-SH18-5M-25RSB	5,00	25,00	28,65	18	1F	27,51	32,00	6,00	13,00	30,50		36,00	5,50	19,00	0,12	
		TL-SH20-5M-25RSB	5,00	25,00	31,83	20	1F	30,69	36,00	6,00	14,00	30,50		36,00	5,50	23,00	0,16	
		TL-SH21-5M-25RSB	5,00	25,00	33,42	21	1F	32,28	38,00	6,00	15,00	30,50		38,00	7,50	24,00	0,19	
		TL-SH22-5M-25RSB	5,00	25,00	35,01	22	1F	33,87	38,00	6,00	16,00	30,50		38,00	7,50	25,50	0,21	
		TL-SH24-5M-25RSB	5,00	25,00	38,20	24	1F	37,06	42,00	6,00	18,00	30,50		38,00	7,50	27,00	0,25	
		TL-SH26-5M-25RSB	5,00	25,00	41,38	26	1F	40,24	44,00	6,00	20,00	30,50		38,00	7,50	30,00	0,30	
		TL-SH28-5M-25RSB	5,00	25,00	44,56	28	1F	43,42	48,00	6,00	20,00	30,50		38,00	7,50	30,50	0,35	
		TL-SH30-5M-25RSB	5,00	25,00	47,75	30	1F	46,60	51,00	6,00	24,00	30,50		38,00	7,50	35,00	0,42	
		TL-SH32-5M-25RSB	5,00	25,00	50,93	32	1F	49,79	54,00	8,00	26,00	30,50		38,00	7,50	38,00	0,48	
		TL-SH36-5M-25RSB	5,00	25,00	57,30	36	1F	56,16	60,00	8,00	26,00	30,50		38,00	7,50	38,00	0,59	
		TL-SH40-5M-25RSB	5,00	25,00	63,66	40	1F	62,52	71,00	8,00	26,00	30,50		38,00	7,50	38,00	0,74	
		TL-SH44-5M-25RSB	5,00	25,00	70,03	44	2N	68,89		8,00	26,00	30,50		40,00	9,50	38,00	0,32	
		TL-SH48-5M-25RSB	5,00	25,00	76,39	48	2N	75,25		8,00	26,00	30,50		40,00	9,50	38,00	0,28	
		TL-SH60-5M-25RSB	5,00	25,00	95,49	60	2N	94,35		8,00	34,00	30,50		40,00	9,50	50,00	0,44	

NEXT >



PROFILE	BELT WIDTH	REFERENCE	PITCH	BELT WIDTH	PITCH DIA PD	NO. TEETH	PULLEY TYPE	OUTER DIA	A	BORE		F	K	L	M	H	WEIGHT
									mm	Min mm	Max mm	mm	mm	mm	mm	mm	mm
		TL-SH72-5M-25RSB	5,00	25,00	114,59	72	2N	113,45		8,00	34,00	30,50		40,00	9,50	50,00	0,53
		TL-SH80-5M-25RSB	5,00	25,00	127,32	80	1N	126,18		8,00	62,00	30,50		40,00		92,00	0,60
8M	20	TL-SH20-8M-20RSB	8,00	20,00	50,93	20	1F	49,56	60,00	12,00	25,00	28,00		38,00		38,00	0,43
		TL-SH21-8M-20RSB	8,00	20,00	53,47	21	1F	52,10	62,00	12,00	27,00	28,00		38,00		40,00	0,49
		TL-SH22-8M-20RSB	8,00	20,00	56,02	22	1F	54,65	65,00	12,00	29,00	28,00		38,00		43,00	0,54
		TL-SH23-8M-20RSB	8,00	20,00	58,57	23	1F	57,20	65,00	12,00	29,00	28,00		38,00		45,00	0,60
		TL-SH24-8M-20RSB	8,00	20,00	61,12	24	1F	59,75	70,00	12,00	30,00	28,00		38,00		45,00	0,65
		TL-SH25-8M-20RSB	8,00	20,00	63,66	25	1F	62,28	71,00	12,00	31,00	28,00		38,00		45,00	0,73
		TL-SH26-8M-20RSB	8,00	20,00	66,21	26	1F	64,84	75,00	12,00	32,00	28,00		38,00		50,00	0,80
		TL-SH27-8M-20RSB	8,00	20,00	68,75	27	1F	67,39	75,00	12,00	33,00	28,00		38,00		50,00	0,84
		TL-SH28-8M-20RSB	8,00	20,00	71,30	28	1F	70,08	80,00	15,00	34,00	28,00		38,00		50,00	0,87
		TL-SH29-8M-20RSB	8,00	20,00	73,85	29	1F	72,62	85,00	15,00	35,00	28,00		38,00		55,00	0,95
		TL-SH30-8M-20RSB	8,00	20,00	76,39	30	1F	75,13	85,00	15,00	36,00	28,00		38,00		55,00	1,02
		TL-SH31-8M-20RSB	8,00	20,00	78,94	31	1F	77,65	87,00	15,00	38,00	28,00		38,00		55,00	1,11
		TL-SH32-8M-20RSB	8,00	20,00	81,49	32	1F	80,16	90,00	15,00	40,00	28,00		38,00		60,00	1,20
		TL-SH33-8M-20RSB	8,00	20,00	84,03	33	1F	82,68	90,00	15,00	42,00	28,00		38,00		60,00	1,30
		TL-SH34-8M-20RSB	8,00	20,00	86,58	34	1F	85,22	95,00	15,00	44,00	28,00		38,00		70,00	1,40
		TL-SH35-8M-20RSB	8,00	20,00	89,13	35	1F	87,76	95,00	15,00	45,00	28,00		38,00		70,00	1,48
		TL-SH36-8M-20RSB	8,00	20,00	91,67	36	1F	90,30	100,00	15,00	46,00	28,00		38,00		70,00	1,55
		TL-SH38-8M-20RSB	8,00	20,00	96,77	38	1F	95,39	105,00	15,00	50,00	28,00		38,00		75,00	1,65
		TL-SH40-8M-20RSB	8,00	20,00	101,86	40	1F	100,49	110,00	15,00	50,00	28,00		38,00		75,00	1,74
		TL-SH42-8M-20RSB	8,00	20,00	106,95	42	1F	105,58	111,00	15,00	50,00	28,00		38,00		75,00	1,92
		TL-SH44-8M-20RSB	8,00	20,00	112,05	44	1F	110,67	121,00	15,00	50,00	28,00		38,00		75,00	2,10
		TL-SH45-8M-20RSB	8,00	20,00	114,59	45	1F	113,22	121,00	15,00	50,00	28,00		38,00		75,00	2,19
		TL-SH48-8M-20RSB	8,00	20,00	122,23	48	1F	120,86	131,00	15,00	54,00	28,00		38,00		75,00	2,44
		TL-SH50-8M-20RSB	8,00	20,00	127,32	50	1F	125,95	131,00	15,00	54,00	28,00		38,00		75,00	2,48
		TL-SH52-8M-20RSB	8,00	20,00	132,42	52	1F	131,05	140,00	15,00	54,00	28,00		38,00		80,00	2,52
		TL-SH56-8M-20RSB	8,00	20,00	142,60	56	2F	141,23	151,00	15,00	54,00	28,00		38,00		80,00	2,60
		TL-SH64-8M-20RSB	8,00	20,00	162,97	64	2F	161,60	172,00	15,00	54,00	28,00		38,00		80,00	2,90
TL-SH72-8M-20RSB	8,00	20,00	183,35	72	2F	181,97	192,00	15,00	54,00	28,00		38,00		80,00	3,10		
TL-SH80-8M-20RSB	8,00	20,00	203,72	80	2N	202,35		15,00	54,00	28,00		38,00		90,00	3,80		
TL-SH90-8M-20RSB	8,00	20,00	229,18	90	2N	227,81		15,00	54,00	28,00		38,00		90,00	4,20		
TL-SH112-8M-20RSB	8,00	20,00	285,21	112	5N	283,83		18,00	54,00	28,00		38,00		90,00	5,20		
TL-SH144-8M-20RSB	8,00	20,00	366,69	144	5N	365,32		20,00	54,00	28,00		38,00		90,00	7,50		
TL-SH168-8M-20RSB	8,00	20,00	427,81	168	5N	426,44		20,00	60,00	28,00		38,00		100,00	10,00		
TL-SH192-8M-20RSB	8,00	20,00	488,92	192	5N	487,55		20,00	60,00	28,00		38,00		100,00	14,40		
8M	30	TL-SH20-8M-30RSB	8,00	30,00	50,93	20	1F	49,56	60,00	12,00	25,00	38,00		48,00		38,00	0,54
		TL-SH21-8M-30RSB	8,00	30,00	53,47	21	1F	52,10	62,00	12,00	27,00	38,00		48,00		40,00	0,62
		TL-SH22-8M-30RSB	8,00	30,00	56,02	22	1F	54,65	65,00	12,00	29,00	38,00		48,00		43,00	0,69
		TL-SH23-8M-30RSB	8,00	30,00	57,57	23	1F	57,20	65,00	12,00	30,00	38,00		48,00		45,00	0,77
		TL-SH24-8M-30RSB	8,00	30,00	61,12	24	1F	59,75	70,00	12,00	30,00	38,00		48,00		45,00	0,84
		TL-SH25-8M-30RSB	8,00	30,00	63,66	25	1F	62,28	71,00	12,00	31,00	38,00		48,00		50,00	0,92
		TL-SH26-8M-30RSB	8,00	30,00	66,21	26	1F	64,84	75,00	12,00	32,00	38,00		48,00		50,00	1,00

NEXT >

TYPE 1N

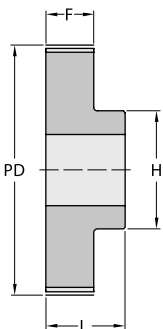

TYPE 1F

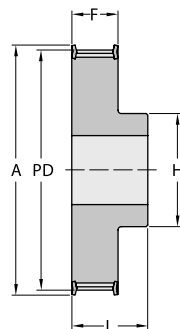

TYPE 2N

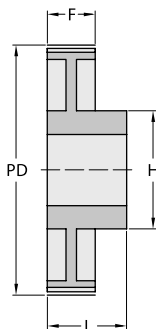

TYPE 2F

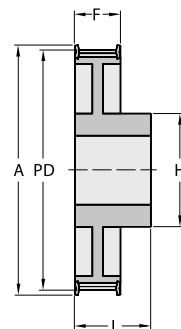

TYPE 5N

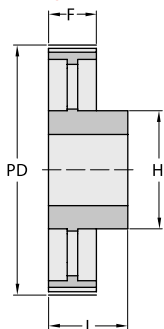

PROFILE	BELT WIDTH	REFERENCE	PITCH	BELT WIDTH	PITCH DIA PD	NO. TEETH	PULLEY TYPE	OUTER DIA	BORE			F	K	L	M	H	WEIGHT
									A	Min mm	Max mm						
8M	30	TL-SH27-8M-30RSB	8,00	30,00	68,75	27	1F	67,39	75,00	12,00	33,00	38,00		48,00		50,00	1,06
		TL-SH28-8M-30RSB	8,00	30,00	71,30	28	1F	70,08	80,00	15,00	34,00	38,00		48,00		50,00	1,12
		TL-SH30-8M-30RSB	8,00	30,00	76,39	30	1F	75,13	85,00	15,00	36,00	38,00		48,00		55,00	1,32
		TL-SH31-8M-30RSB	8,00	30,00	78,94	31	1F	77,65	87,00	15,00	38,00	38,00		48,00		55,00	1,42
		TL-SH32-8M-30RSB	8,00	30,00	81,49	32	1F	80,16	90,00	15,00	40,00	38,00		48,00		60,00	1,53
		TL-SH33-8M-30RSB	8,00	30,00	84,03	33	1F	82,68	90,00	15,00	42,00	38,00		48,00		60,00	1,64
		TL-SH34-8M-30RSB	8,00	30,00	86,58	34	1F	85,22	95,00	15,00	44,00	38,00		48,00		70,00	1,80
		TL-SH35-8M-30RSB	8,00	30,00	89,13	35	1F	87,76	95,00	15,00	45,00	38,00		48,00		70,00	1,90
		TL-SH36-8M-30RSB	8,00	30,00	91,67	36	1F	90,30	100,00	15,00	46,00	38,00		48,00		70,00	1,99
		TL-SH38-8M-30RSB	8,00	30,00	96,77	38	1F	95,39	105,00	15,00	50,00	38,00		48,00		75,00	2,27
		TL-SH40-8M-30RSB	8,00	30,00	101,86	40	1F	100,49	110,00	15,00	50,00	38,00		48,00		75,00	2,40
		TL-SH42-8M-30RSB	8,00	30,00	106,95	42	1F	105,58	111,00	15,00	50,00	38,00		48,00		75,00	2,60
		TL-SH44-8M-30RSB	8,00	30,00	112,05	44	1F	110,67	121,00	15,00	50,00	38,00		48,00		75,00	2,80
		TL-SH45-8M-30RSB	8,00	30,00	114,59	45	1F	113,22	121,00	15,00	50,00	38,00		48,00		75,00	2,90
		TL-SH48-8M-30RSB	8,00	30,00	122,23	48	1F	120,86	131,00	15,00	50,00	38,00		48,00		75,00	3,20
		TL-SH50-8M-30RSB	8,00	30,00	127,32	50	1F	125,95	131,00	15,00	50,00	38,00		48,00		75,00	3,30
		TL-SH52-8M-30RSB	8,00	30,00	132,42	52	1F	131,05	140,00	15,00	60,00	38,00		48,00		90,00	3,40
		TL-SH56-8M-30RSB	8,00	30,00	142,60	56	2F	141,23	151,00	15,00	60,00	38,00		48,00		90,00	3,60
		TL-SH60-8M-30RSB	8,00	30,00	152,79	60	2F	151,42	168,00	15,00	60,00	38,00		48,00		90,00	3,95
		TL-SH64-8M-30RSB	8,00	30,00	162,97	64	2F	161,60	172,00	15,00	60,00	38,00		48,00		90,00	4,30
TL-SH72-8M-30RSB	8,00	30,00	183,35	72	2F	181,97	192,00	15,00	63,00	38,00		48,00		95,00	4,80		
TL-SH80-8M-30RSB	8,00	30,00	203,72	80	2N	202,35		15,00	60,00	38,00		48,00		100,00	5,10		
TL-SH90-8M-30RSB	8,00	30,00	229,18	90	2N	227,81		15,00	60,00	38,00		48,00		100,00	5,70		
TL-SH112-8M-30RSB	8,00	30,00	285,21	112	5N	283,83			18,00	60,00	38,00		48,00		100,00	6,80	
TL-SH144-8M-30RSB	8,00	30,00	366,69	144	5N	365,32			20,00	60,00	38,00		48,00		100,00	9,30	
TL-SH168-8M-30RSB	8,00	30,00	427,81	168	5N	426,44			20,00	60,00	38,00		48,00		100,00	11,40	
TL-SH192-8M-30RSB	8,00	30,00	488,92	192	5N	487,55			20,00	60,00	38,00		48,00		100,00	16,00	
8M	50	TL-SH22-8M-50RSB	8,00	50,00	56,02	22	1F	54,65	65,00	12,00	29,00	60,00		70,00		43,00	1,00
		TL-SH23-8M-50RSB	8,00	50,00	58,57	23	1F	57,20	65,00	12,00	30,00	60,00		70,00		45,00	1,12
		TL-SH24-8M-50RSB	8,00	50,00	61,12	24	1F	59,75	70,00	12,00	30,00	60,00		70,00		45,00	1,23
		TL-SH25-8M-50RSB	8,00	50,00	63,66	25	1F	62,28	70,00	12,00	34,00	60,00		70,00		50,00	1,37
		TL-SH26-8M-50RSB	8,00	50,00	66,21	26	1F	64,84	75,00	12,00	34,00	60,00		70,00		50,00	1,50
		TL-SH27-8M-50RSB	8,00	50,00	68,75	27	1F	67,39	75,00	15,00	34,00	60,00		70,00		50,00	1,59
		TL-SH28-8M-50RSB	8,00	50,00	71,30	28	1F	70,08	80,00	15,00	34,00	60,00		70,00		50,00	1,67
		TL-SH30-8M-50RSB	8,00	50,00	76,39	30	1F	75,13	85,00	15,00	38,00	60,00		70,00		55,00	1,97
		TL-SH31-8M-50RSB	8,00	50,00	78,94	31	1F	77,65	87,00	15,00	38,00	60,00		70,00		55,00	2,12
		TL-SH32-8M-50RSB	8,00	50,00	81,49	32	1F	80,16	90,00	15,00	40,00	60,00		70,00		60,00	2,27
		TL-SH33-8M-50RSB	8,00	50,00	84,03	33	1F	82,68	90,00	15,00	42,00	60,00		70,00		60,00	2,42
		TL-SH34-8M-50RSB	8,00	50,00	86,58	34	1F	85,22	95,00	15,00	44,00	60,00		70,00		70,00	2,69
		TL-SH35-8M-50RSB	8,00	50,00	89,13	35	1F	87,76	95,00	15,00	45,00	60,00		70,00		70,00	2,83
		TL-SH36-8M-50RSB	8,00	50,00	91,67	36	1F	90,30	100,00	15,00	46,00	60,00		70,00		70,00	2,97
		TL-SH38-8M-50RSB	8,00	50,00	96,77	38	1F	95,39	105,00	15,00	50,00	60,00		70,00		75,00	3,23
		TL-SH40-8M-50RSB	8,00	50,00	101,86	40	1F	100,49	110,00	18,00	50,00	60,00		70,00		75,00	3,50
		TL-SH42-8M-50RSB	8,00	50,00	104,41	42	1F	103,03	111,00	18,00	50,00	60,00		70,00		75,00	3,70
		TL-SH44-8M-50RSB	8,00	50,00	112,05	44	1F	110,67	121,00	18,00	50,00	60,00		70,00		75,00	3,90
		TL-SH45-8M-50RSB	8,00	50,00	114,59	45	1F	113,22	121,00	18,00	50,00	60,00		70,00		75,00	4,00
		TL-SH48-8M-50RSB	8,00	50,00	122,23	48	1F	120,86	131,00	18,00	54,00	60,00		70,00		80,00	4,30
TL-SH50-8M-50RSB	8,00	50,00	124,78	50	1F	123,41	131,00	18,00	54,00	60,00		70,00		80,00	4,48		
TL-SH52-8M-50RSB	8,00	50,00	127,32	52	1F	125,95	140,00	18,00	60,00	60,00		70,00		90,00	4,65		
TL-SH56-8M-50RSB	8,00	50,00	142,60	56	7F	141,23	151,00	18,00	60,00	60,00		60,00		90,00	5,00		
TL-SH60-8M-50RSB	8,00	50,00	152,79	60	7F	151,42	158,00	18,00	60,00	60,00		60,00		90,00	5,30		
TL-SH64-8M-50RSB	8,00	50,00	162,97	64	7F	161,60	171,00	18,00	60,00	60,00		60,00		100,00	5,60		
TL-SH72-8M-50RSB	8,00	50,00	183,35	72	7F	181,97	192,00	18,00	63,00	60,00		60,00		100,00	6,80		
TL-SH80-8M-50RSB	8,00	50,00	203,72	80	7N	202,35			18,00	60,00	60,00		60,00		110,00	6,90	
TL-SH90-8M-50RSB	8,00	50,00	229,18	90	7N	227,81			18,00	60,00	60,00		60,00		110,00	8,60	
TL-SH112-8M-50RSB	8,00	50,00	285,21	112	3N	283,83			20,00	60,00	60,00		60,00		110,00	9,60	
TL-SH144-8M-50RSB	8,00	50,00	366,69	144	3N	365,32			20,00	60,00	60,00		60,00		110,00	13,80	

NEXT >



PROFILE	BELT WIDTH	REFERENCE	PITCH	BELT WIDTH	PITCH DIA PD	NO. TEETH	PULLEY TYPE	OUTER DIA	A		BORE		F	K	L	M	H	WEIGHT
									mm	mm	Min mm	Max mm						
		TL-SH168-8M-50RSB	8,00	50,00	427,81	168	3N	426,44		20,00	60,00	60,00			60,00		120,00	16,00
		TL-SH192-8M-50RSB	8,00	50,00	488,92	192	3N	487,55		20,00	60,00	60,00			60,00		130,00	22,40
8M	85	TL-SH22-8M-85RSB	8,00	85,00	56,02	22	1F	54,65	65,00	12,00	29,00	95,00			105,00		43,00	1,55
		TL-SH23-8M-85RSB	8,00	85,00	58,57	23	1F	57,20	65,00	12,00	30,00	95,00			105,00		45,00	1,73
		TL-SH24-8M-85RSB	8,00	85,00	61,12	24	1F	59,75	70,00	12,00	30,00	95,00			105,00		45,00	1,90
		TL-SH25-8M-85RSB	8,00	85,00	63,66	25	1F	62,28	70,00	12,00	34,00	95,00			105,00		50,00	2,08
		TL-SH26-8M-85RSB	8,00	85,00	66,21	26	1F	64,84	75,00	12,00	34,00	95,00			105,00		50,00	2,25
		TL-SH27-8M-85RSB	8,00	85,00	68,75	27	1F	67,39	75,00	12,00	34,00	95,00			105,00		50,00	2,40
		TL-SH28-8M-85RSB	8,00	85,00	71,30	28	1F	70,08	80,00	15,00	34,00	95,00			105,00		50,00	2,55
		TL-SH30-8M-85RSB	8,00	85,00	76,39	30	1F	75,13	85,00	15,00	35,00	95,00			105,00		55,00	3,00
		TL-SH31-8M-85RSB	8,00	85,00	78,94	31	1F	77,65	87,00	15,00	38,00	95,00			105,00		55,00	3,23
		TL-SH32-8M-85RSB	8,00	85,00	81,49	32	1F	80,16	90,00	15,00	42,00	95,00			105,00		60,00	3,57
		TL-SH33-8M-85RSB	8,00	85,00	84,03	33	1F	82,68	90,00	15,00	44,00	95,00			105,00		60,00	3,75
		TL-SH34-8M-85RSB	8,00	85,00	86,58	34	1F	85,22	95,00	15,00	44,00	95,00			105,00		70,00	4,00
		TL-SH35-8M-85RSB	8,00	85,00	89,13	35	1F	87,76	95,00	15,00	44,00	95,00			105,00		70,00	4,25
		TL-SH36-8M-85RSB	8,00	85,00	91,67	36	1F	90,30	100,00	15,00	44,00	95,00			105,00		70,00	4,50
		TL-SH38-8M-85RSB	8,00	85,00	96,77	38	1F	95,39	106,00	15,00	50,00	95,00			105,00		75,00	4,90
		TL-SH40-8M-85RSB	8,00	85,00	101,86	40	1F	100,49	110,00	18,00	50,00	95,00			105,00		75,00	5,20
		TL-SH42-8M-85RSB	8,00	85,00	106,95	42	1F	105,58	110,00	18,00	50,00	95,00			105,00		75,00	6,08
		TL-SH44-8M-85RSB	8,00	85,00	112,05	44	1F	110,67	121,00	18,00	50,00	95,00			105,00		75,00	6,60
		TL-SH45-8M-85RSB	8,00	85,00	114,59	45	1F	113,22	121,00	18,00	50,00	95,00			105,00		75,00	6,85
		TL-SH48-8M-85RSB	8,00	85,00	122,23	48	1F	120,86	131,00	18,00	54,00	95,00			105,00		80,00	7,60
TL-SH50-8M-85RSB	8,00	85,00	127,32	50	1F	125,95	131,00	20,00	54,00	95,00			105,00		80,00	8,15		
TL-SH52-8M-85RSB	8,00	85,00	132,42	52	1F	131,05	140,00	20,00	54,00	95,00			105,00		80,00	8,70		
TL-SH56-8M-85RSB	8,00	85,00	142,60	56	1F	141,23	151,00	20,00	54,00	95,00			105,00		80,00	9,80		
TL-SH60-8M-85RSB	8,00	85,00	152,79	60	7F	151,42	158,00	20,00	66,00	95,00			95,00		100,00	10,10		
TL-SH64-8M-85RSB	8,00	85,00	162,97	64	7F	161,60	171,00	20,00	66,00	95,00			95,00		100,00	10,40		
TL-SH72-8M-85RSB	8,00	85,00	183,35	72	7F	181,97	192,00	20,00	66,00	95,00			95,00		110,00	11,40		
TL-SH80-8M-85RSB	8,00	85,00	203,72	80	3N	202,35		20,00	66,00	95,00			95,00		110,00	11,10		
TL-SH90-8M-85RSB	8,00	85,00	229,18	90	3N	227,81		20,00	66,00	95,00			95,00		110,00	13,20		
TL-SH112-8M-85RSB	8,00	85,00	285,21	112	3N	283,83		24,00	66,00	95,00			95,00		110,00	16,30		
TL-SH144-8M-85RSB	8,00	85,00	366,69	144	3N	365,32		24,00	72,00	95,00			95,00		120,00	21,50		
TL-SH168-8M-85RSB	8,00	85,00	427,81	168	3N	426,44		24,00	72,00	95,00			95,00		120,00	26,10		
TL-SH192-8M-85RSB	8,00	85,00	488,92	192	3N	487,55		24,00	78,00	95,00			95,00		130,00	30,60		
14M	40	TL-SH28-14M-40RSB	14,00	40,00	124,78	28	1F	122,12	127,00	24,00	67,00	54,00			69,00		100,00	4,73
		TL-SH29-14M-40RSB	14,00	40,00	129,23	29	1F	126,57	138,00	24,00	67,00	54,00			69,00		100,00	5,09
		TL-SH30-14M-40RSB	14,00	40,00	133,69	30	1F	130,99	138,00	24,00	67,00	54,00			69,00		100,00	5,45
		TL-SH32-14M-40RSB	14,00	40,00	142,60	32	1F	139,88	154,00	24,00	67,00	54,00			69,00		100,00	6,17
		TL-SH34-14M-40RSB	14,00	40,00	151,52	34	1F	148,79	160,00	24,00	67,00	54,00			69,00		100,00	6,88
		TL-SH36-14M-40RSB	14,00	40,00	160,43	36	1F	157,68	168,00	24,00	67,00	54,00			69,00		100,00	7,60
		TL-SH38-14M-40RSB	14,00	40,00	169,34	38	1F	166,60	183,00	24,00	80,00	54,00			69,00		120,00	8,28
		TL-SH40-14M-40RSB	14,00	40,00	178,25	40	1F	175,49	188,00	24,00	80,00	54,00			69,00		120,00	9,26
TL-SH44-14M-40RSB	14,00	40,00	196,08	44	1F	193,28	211,00	24,00	80,00	54,00			69,00		120,00	10,32		

NEXT >

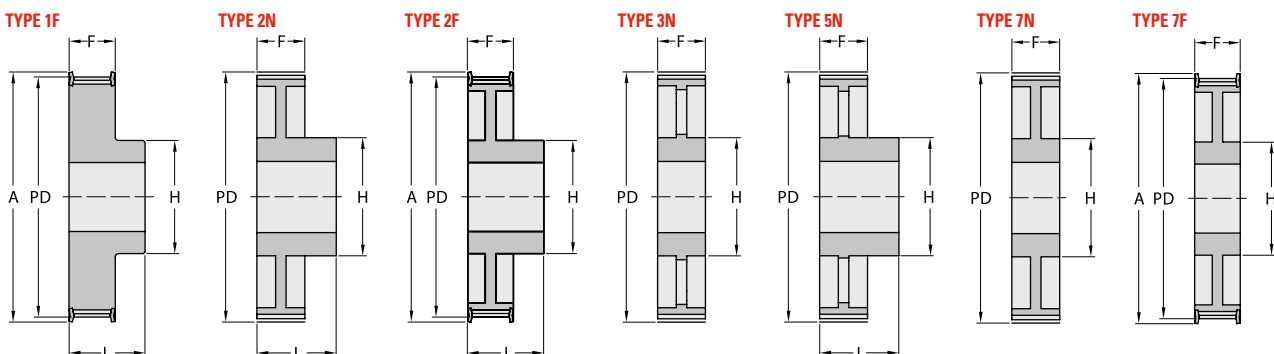

PROFILE	BELT WIDTH	REFERENCE	PITCH	BELT WIDTH	PITCH DIA PD	NO. TEETH	PULLEY TYPE	OUTER DIA	BORE			F	K	L	M	H	WEIGHT
									A	Min mm	Max mm						
		TL-SH34-14M-115RSB	14,00	115,00	151,52	34	1F	148,79	160,00	32,00	67,00	133,00		148,00		100,00	14,80
		TL-SH36-14M-115RSB	14,00	115,00	160,43	36	1F	157,68	168,00	32,00	80,00	133,00		148,00		120,00	16,60
		TL-SH38-14M-115RSB	14,00	115,00	169,34	38	1F	166,60	183,00	32,00	80,00	133,00		148,00		120,00	19,20
		TL-SH40-14M-115RSB	14,00	115,00	178,25	40	1F	175,49	188,00	32,00	90,00	133,00		148,00		135,00	20,56
		TL-SH44-14M-115RSB	14,00	115,00	196,08	44	1F	193,28	211,00	32,00	94,00	133,00		148,00		140,00	26,00
		TL-SH48-14M-115RSB	14,00	115,00	213,90	48	1F	211,11	226,00	32,00	100,00	133,00		148,00		150,00	30,00
		TL-SH56-14M-115RSB	14,00	115,00	249,55	56	1F	246,76	256,00	32,00	100,00	133,00		148,00		150,00	36,00
		TL-SH64-14M-115RSB	14,00	115,00	285,21	64	7F	282,41	296,00	32,00	90,00	133,00		133,00		150,00	39,00
		TL-SH72-14M-115RSB	14,00	115,00	320,86	72	3N	318,06		32,00	90,00	133,00		133,00		150,00	32,83
		TL-SH80-14M-115RSB	14,00	115,00	356,51	80	3N	353,71		32,00	90,00	133,00		133,00		150,00	35,55
		TL-SH90-14M-115RSB	14,00	115,00	401,07	90	3N	398,28		32,00	90,00	133,00		133,00		150,00	41,00
		TL-SH112-14M-115RSB	14,00	115,00	499,11	112	3N	496,32		32,00	90,00	133,00		133,00		150,00	54,40
		TL-SH144-14M-115RSB	14,00	115,00	641,71	144	3N	638,92		32,00	100,00	133,00		133,00		165,00	67,80
		TL-SH168-14M-115RSB	14,00	115,00	748,66	168	3N	745,87		32,00	100,00	133,00		133,00		165,00	75,80
		TL-SH192-14M-115RSB	14,00	115,00	855,92	192	3N	852,82		32,00	100,00	133,00		133,00		165,00	90,30
		TL-SH216-14M-115RSB	14,00	115,00	962,57	216	3N	959,76		32,00	100,00	133,00		133,00		165,00	105,00
14M	170	TL-SH28-14M-170RSB	14,00	170,00	124,78	28	1F	122,12	127,00	32,00	67,00	187,00		202,00		100,00	13,80
		TL-SH29-14M-170RSB	14,00	170,00	129,23	29	1F	126,57	138,00	32,00	67,00	187,00		202,00		100,00	14,20
		TL-SH30-14M-170RSB	14,00	170,00	133,69	30	1F	130,99	138,00	32,00	67,00	187,00		202,00		100,00	15,60
		TL-SH32-14M-170RSB	14,00	170,00	142,60	32	1F	139,88	154,00	32,00	67,00	187,00		202,00		100,00	18,10
		TL-SH34-14M-170RSB	14,00	170,00	151,52	34	1F	148,79	160,00	32,00	67,00	187,00		202,00		100,00	20,40
		TL-SH36-14M-170RSB	14,00	170,00	160,43	36	1F	157,68	168,00	32,00	80,00	187,00		202,00		120,00	23,50
		TL-SH38-14M-170RSB	14,00	170,00	169,34	38	1F	166,60	183,00	32,00	90,00	187,00		202,00		135,00	26,50
		TL-SH40-14M-170RSB	14,00	170,00	178,25	40	1F	175,49	188,00	32,00	94,00	187,00		202,00		140,00	30,10
		TL-SH44-14M-170RSB	14,00	170,00	196,08	44	1F	193,28	211,00	32,00	100,00	187,00		202,00		160,00	37,80
		TL-SH48-14M-170RSB	14,00	170,00	213,90	48	1F	211,11	226,00	32,00	107,00	187,00		202,00		160,00	44,50
		TL-SH56-14M-170RSB	14,00	170,00	249,55	56	1F	246,76	256,00	32,00	110,00	187,00		202,00		160,00	61,00
		TL-SH64-14M-170RSB	14,00	170,00	285,21	64	1F	282,41	296,00	32,00	120,00	187,00		202,00		180,00	61,20
		TL-SH72-14M-170RSB	14,00	170,00	320,86	72	7F	318,06		32,00	120,00	187,00		187,00		180,00	61,40
		TL-SH80-14M-170RSB	14,00	170,00	356,51	80	7F	353,71		32,00	108,00	187,00		187,00		180,00	65,00
		TL-SH90-14M-170RSB	14,00	170,00	401,07	90	7N	398,28		32,00	108,00	187,00		187,00		180,00	68,00
		TL-SH112-14M-170RSB	14,00	170,00	499,11	112	7N	496,32		32,00	108,00	187,00		187,00		200,00	87,50
		TL-SH144-14M-170RSB	14,00	170,00	641,71	144	7N	638,92		32,00	108,00	187,00		187,00		220,00	114,80
		TL-SH168-14M-170RSB	14,00	170,00	748,66	168	7N	745,87		32,00	108,00	187,00		187,00		220,00	125,00
TL-SH192-14M-170RSB	14,00	170,00	855,92	192	7N	852,82		32,00	108,00	187,00		187,00		220,00	136,40		
TL-SH216-14M-170RSB	14,00	170,00	962,57	216	7N	959,76		32,00	108,00	187,00		187,00		220,00	147,00		

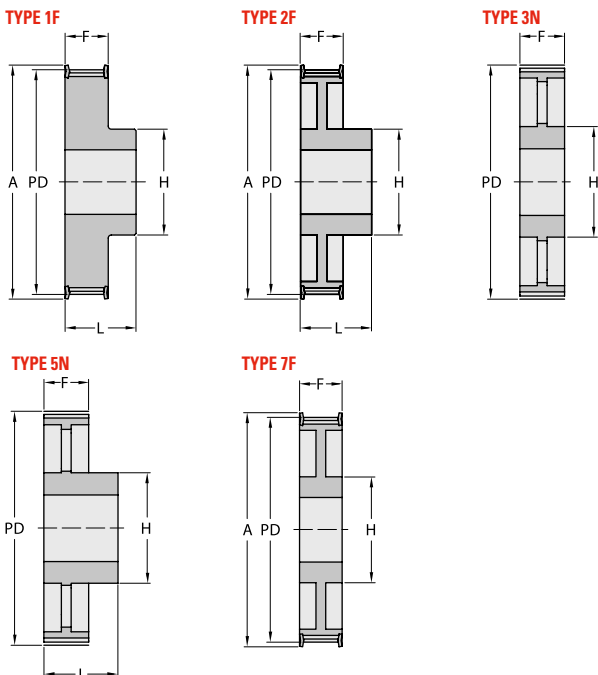

NOMENCLATOR

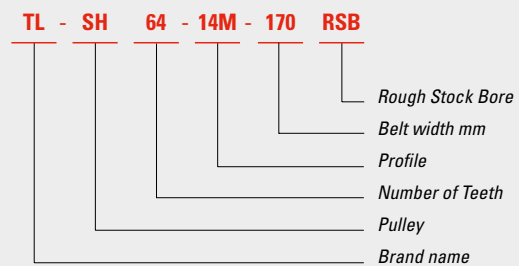

TIMING PULLEYS PROFILE HTD® 3M, 5M, 8M, 14M. TB TAPER BUSH

PROFILE	PITCH	BELT WIDTH
	mm	mm
3M	3,00	9,00
		15,00
5M	5,00	9,00
		15,00
		25,00
8M	8,00	20,00
		30,00
		50,00
		85,00
14M	14,00	40,00
		55,00
		85,00
		115,00
		170,00



HTD, 15 mm Profile Timing Belt

Reference nomenclature: An alphanumeric string with blocks designating the product family SH, the number of teeth, the belt section matching the Timing Pulley profile, the width expressed in mm, the fixing mode of the pulley to shaft and finally a block indicating an specific requirement if any.

PROFILE. HTD® 3M, 5M, 8M, 14M. TB TAPER BUSH

PROFILE	BELT WIDTH	REFERENCE	PITCH	BELT WIDTH	PITCH DIA PD	NO. TEETH	PULLEY TYPE	BUSH TYPE	OUTER DIA	A		BORE		F	K	L	M	H	WEIGHT
										mm	mm	Min mm	Max mm						
5M	15	TL-SH34-5M-15TB	5,00	15,00	54,11	34	3F	1008	52,97	58,00	9,00	25,00	20,50			22,00	1,50	43,00	0,19
		TL-SH36-5M-15TB	5,00	15,00	57,30	36	3F	1108	56,16	61,00	9,00	28,00	20,50			22,00	1,50	45,00	0,20
		TL-SH38-5M-15TB	5,00	15,00	60,48	38	3F	1108	59,34	65,00	9,00	28,00	20,50			22,00	1,50	48,00	0,25
		TL-SH40-5M-15TB	5,00	15,00	66,00	40	3F	1108	62,52	68,00	9,00	28,00	20,50			22,00	1,50	52,00	0,31
		TL-SH44-5M-15TB	5,00	15,00	70,03	44	3F	1108	68,89	74,00	9,00	28,00	20,50			22,00	1,50	54,00	0,40
		TL-SH48-5M-15TB	5,00	15,00	76,39	48	3F	1210	75,25	80,00	11,00	32,00	20,50			25,00	4,50	64,00	0,45
		TL-SH56-5M-15TB	5,00	15,00	89,13	56	3F	1210	87,99	93,00	11,00	32,00	20,50			25,00	4,50	70,00	0,67
		TL-SH64-5M-15TB	5,00	15,00	101,86	64	3F	1210	100,72	106,00	11,00	32,00	20,50			25,00	4,50	78,00	0,96
		TL-SH72-5M-15TB	5,00	15,00	114,59	72	3F	1610	113,45	118,00	14,00	42,00	20,50			25,00	4,50	90,00	1,19
		TL-SH80-5M-15TB	5,00	15,00	127,32	80	3F	1610	126,18	135,00	14,00	42,00	20,50			25,00	4,50	92,00	1,57
		TL-SH90-5M-15TB	5,00	15,00	143,24	90	10N	1610	142,10		14,00	42,00	20,50	2,30	25,00	2,30	92,00	1,47	
		TL-SH112-5M-15TB	5,00	15,00	178,25	112	10N	1610	177,11		14,00	42,00	20,50	2,30	25,00	2,30	92,00	1,94	
		TL-SH136-5M-15TB	5,00	15,00	216,45	136	10N	2012	215,31		14,00	50,00	20,50	5,80	32,00	5,80	106,00	3,06	
		TL-SH150-5M-15TB	5,00	15,00	238,73	150	10N	2012	237,51		14,00	50,00	20,50	5,80	32,00	5,80	106,00	4,50	
8M	20	TL-SH22-8M-20TB	8,00	20,00	56,02	22	4F	1008	54,65	65,00	9,00	25,00	28,00	6,00	22,00				0,24
		TL-SH24-8M-20TB	8,00	20,00	61,12	24	4F	1108	59,75	70,00	9,00	28,00	28,00	6,00	22,00				0,30
		TL-SH26-8M-20TB	8,00	20,00	66,21	26	4F	1108	64,84	75,00	9,00	28,00	28,00	6,00	22,00				0,36
		TL-SH28-8M-20TB	8,00	20,00	71,30	28	4F	1108	70,08	80,00	9,00	28,00	28,00	6,00	22,00				0,44
		TL-SH30-8M-20TB	8,00	20,00	76,39	30	4F	1108	75,13	85,00	11,00	28,00	28,00	6,00	22,00				0,45
		TL-SH32-8M-20TB	8,00	20,00	81,49	32	4F	1610	80,16	90,00	11,00	42,00	28,00	3,00	25,00				0,50
		TL-SH34-8M-20TB	8,00	20,00	86,58	34	4F	1610	85,22	95,00	14,00	42,00	28,00	3,00	25,00				0,55
		TL-SH36-8M-20TB	8,00	20,00	91,67	36	4F	1610	90,30	100,00	14,00	42,00	28,00	3,00	25,00				0,68
		TL-SH38-8M-20TB	8,00	20,00	96,77	38	4F	1610	95,39	106,00	14,00	42,00	28,00	3,00	25,00				0,80
		TL-SH40-8M-20TB	8,00	20,00	101,86	40	4F	1610	100,49	110,00	14,00	42,00	28,00	3,00	25,00				1,00
		TL-SH42-8M-20TB	8,00	20,00	106,95	42	4F	1610	105,58	110,00	14,00	42,00	28,00	3,00	25,00				1,11
		TL-SH44-8M-20TB	8,00	20,00	112,05	44	3F	2012	110,67	121,00	14,00	50,00	28,00		32,00	4,00	92,00	1,20	
		TL-SH48-8M-20TB	8,00	20,00	122,23	48	3F	2012	120,86	131,00	14,00	50,00	28,00		32,00	4,00	96,00	1,60	
		TL-SH56-8M-20TB	8,00	20,00	142,60	56	3F	2012	141,23	151,00	14,00	50,00	28,00		32,00	4,00	110,00	2,40	
		TL-SH60-8M-20TB	8,00	20,00	152,79	60	3F	2012	151,42	162,00	14,00	50,00	28,00		32,00	4,00	110,00	2,55	
		TL-SH64-8M-20TB	8,00	20,00	162,97	64	12F	2012	161,60	171,00	14,00	50,00	28,00		32,00	4,00	110,00	2,70	

NEXT >

PROFILE	BELT WIDTH	REFERENCE	PITCH	BELT WIDTH	PITCH DIA PD	NO. TEETH	PULLEY TYPE	BUSH TYPE	OUTER DIA	BORE			F	K	L	M	H	WEIGHT
										A	Min mm	Max mm						
		TL-SH72-8M-20TB	8,00	20,00	183,35	72	12F	2012	181,97	192,00	14,00	50,00	28,00		32,00	4,00	110,00	3,30
		TL-SH80-8M-20TB	8,00	20,00	203,72	80	12N	2012	202,35		16,00	50,00	28,00		32,00	4,00	110,00	3,50
		TL-SH90-8M-20TB	8,00	20,00	229,18	90	12N	2012	227,81		16,00	50,00	28,00		32,00	4,00	110,00	3,65
8M	30	TL-SH20-8M-30TB	8,00	30,00	50,93	20	4F	1008	49,56	60,00	9,00	25,00	38,00	16,00	22,00			0,23
		TL-SH21-8M-30TB	8,00	30,00	53,47	21	4F	1008	52,10	65,00	9,00	25,00	38,00	16,00	22,00			0,26
		TL-SH22-8M-30TB	8,00	30,00	56,02	22	4F	1008	54,65	65,00	9,00	25,00	38,00	16,00	22,00			0,29
		TL-SH23-8M-30TB	8,00	30,00	58,57	23	4F	1108	57,20	70,00	9,00	28,00	38,00	16,00	22,00			0,32
		TL-SH24-8M-30TB	8,00	30,00	61,12	24	4F	1108	59,75	70,00	9,00	28,00	38,00	16,00	22,00			0,38
		TL-SH25-8M-30TB	8,00	30,00	63,66	25	4F	1108	62,29	75,00	9,00	28,00	38,00	16,00	22,00			0,41
		TL-SH26-8M-30TB	8,00	30,00	66,21	26	4F	1108	64,84	75,00	9,00	28,00	38,00	16,00	22,00			0,45
		TL-SH27-8M-30TB	8,00	30,00	68,75	27	4F	1108	67,38	80,00	9,00	28,00	38,00	16,00	22,00			0,49
		TL-SH28-8M-30TB	8,00	30,00	71,30	28	4F	1210	70,08	80,00	11,00	32,00	38,00	16,00	25,00			0,50
		TL-SH30-8M-30TB	8,00	30,00	76,39	30	2F	1615	75,13	85,00	11,00	42,00	38,00		38,00			0,55
		TL-SH31-8M-30TB	8,00	30,00	78,94	31	2F	1615	77,57	90,00	14,00	42,00	38,00		38,00			0,57
		TL-SH32-8M-30TB	8,00	30,00	81,49	32	2F	1615	80,16	90,00	14,00	42,00	38,00		38,00			0,59
		TL-SH33-8M-30TB	8,00	30,00	84,03	33	2F	1615	82,66	95,00	14,00	42,00	38,00		38,00			0,73
		TL-SH34-8M-30TB	8,00	30,00	86,58	34	2F	1615	85,22	95,00	14,00	42,00	38,00		38,00			0,77
		TL-SH35-8M-30TB	8,00	30,00	89,13	35	2F	1615	87,75	100,00	14,00	42,00	38,00		38,00			0,82
		TL-SH36-8M-30TB	8,00	30,00	91,67	36	2F	1615	90,30	100,00	14,00	42,00	38,00		38,00			0,96
		TL-SH38-8M-30TB	8,00	30,00	96,77	38	2F	1615	95,39	106,00	14,00	42,00	38,00		38,00			1,15
		TL-SH40-8M-30TB	8,00	30,00	101,86	40	2F	1615	100,49	110,00	14,00	42,00	38,00		38,00			1,34
		TL-SH42-8M-30TB	8,00	30,00	106,95	42	2F	1615	105,58	110,00	14,00	42,00	38,00		38,00			1,36
		TL-SH44-8M-30TB	8,00	30,00	112,05	44	6F	2012	110,67	121,00	14,00	50,00	38,00	6,00	32,00			1,33
		TL-SH45-8M-30TB	8,00	30,00	114,59	45	6F	2012	113,22	121,00	14,00	50,00	38,00	6,00	32,00			1,62
		TL-SH48-8M-30TB	8,00	30,00	122,23	48	6F	2012	120,86	131,00	14,00	50,00	38,00	6,00	32,00			1,78
		TL-SH50-8M-30TB	8,00	30,00	127,32	50	6F	2012	125,95	136,00	14,00	50,00	38,00	3,00	32,00	3,00		2,08
		TL-SH52-8M-30TB	8,00	30,00	132,42	52	6F	2012	131,04	141,00	14,00	50,00	38,00	3,00	32,00	3,00		2,39
		TL-SH56-8M-30TB	8,00	30,00	142,60	56	6F	2012	141,23	151,00	14,00	50,00	38,00	6,00	32,00			3,76
		TL-SH58-8M-30TB	8,00	30,00	147,70	58	6F	2012	146,32	156,00	14,00	50,00	38,00	3,00	32,00	3,00		3,87
		TL-SH60-8M-30TB	8,00	30,00	152,79	60	6F	2517	151,42	162,00	16,00	60,00	38,00	3,00	45,00	3,00		3,98
		TL-SH64-8M-30TB	8,00	30,00	162,97	64	3F	2517	161,60	171,00	16,00	60,00	38,00		45,00	7,00	125,00	4,20

NEXT >

TYPE 2F

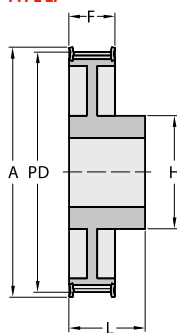

TYPE 3F

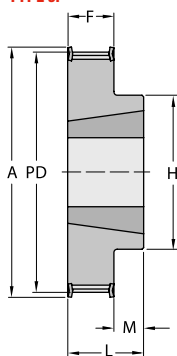

TYPE 4F

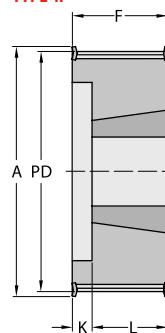

TYPE 6F

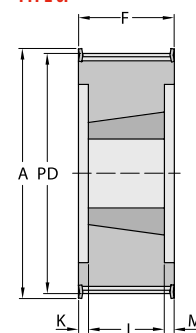

TYPE 7F

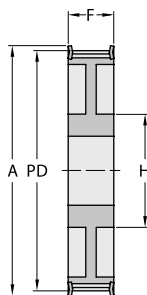

TYPE 10N

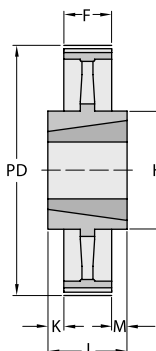

TYPE 12N

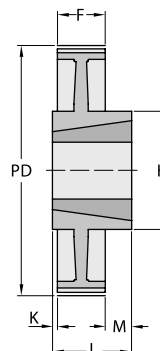

TYPE 12F

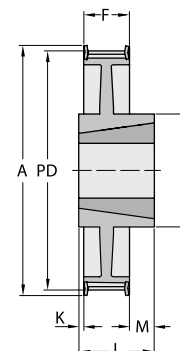

PROFILE	BELT WIDTH	REFERENCE	PITCH	BELT WIDTH	PITCH DIA PD	NO. TEETH	PULLEY TYPE	BUSH TYPE	OUTER DIA	A		BORE		F	K	L	M	H	WEIGHT
										mm	mm	Min mm	Max mm						
		TL-SH64-8M-85TB	8,00	85,00	162,97	64	7F	2517	161,60	171,00	16,00	60,00	95,00	25,00	45,00	25,00			6,20
		TL-SH72-8M-85TB	8,00	85,00	183,35	72	7N	3020	181,97	192,00	25,00	75,00	95,00	22,00	51,00	22,00			8,00
		TL-SH80-8M-85TB	8,00	85,00	203,72	80	8N	3020	202,35		25,00	75,00	95,00	22,00	51,00	22,00			10,00
		TL-SH90-8M-85TB	8,00	85,00	229,18	90	8N	3020	227,81		25,00	75,00	95,00	22,00	51,00	22,00			10,80
		TL-SH112-8M-85TB	8,00	85,00	285,21	112	8N	3020	283,83		25,00	75,00	95,00	22,00	51,00	22,00	170,00		15,00
		TL-SH144-8M-85TB	8,00	85,00	366,69	144	8N	3535	365,32		35,00	90,00	95,00	3,00	89,00	3,00	190,00		20,00
		TL-SH168-8M-85TB	8,00	85,00	427,81	168	8N	3535	426,44		35,00	90,00	95,00	3,00	89,00	3,00	190,00		23,00
		TL-SH192-8M-85TB	8,00	85,00	488,92	192	8N	3535	487,55		35,00	90,00	95,00	3,00	89,00	3,00	190,00		28,50
14M	40	TL-SH28-14M-40TB	14,00	40,00	124,78	28	6F	2012	122,12	141,00	14,00	50,00	54,00	11,00	32,00	11,00			2,66
		TL-SH29-14M-40TB	14,00	40,00	129,23	29	6F	2012	126,57	141,00	14,00	50,00	54,00	11,00	32,00	11,00			2,66
		TL-SH30-14M-40TB	14,00	40,00	133,69	30	6F	2012	130,99	156,00	14,00	50,00	54,00	11,00	32,00	11,00			2,89
		TL-SH32-14M-40TB	14,00	40,00	142,60	32	6F	2012	139,88	156,00	14,00	50,00	54,00	11,00	32,00	11,00			3,51
		TL-SH34-14M-40TB	14,00	40,00	151,52	34	6F	2517	148,79	165,00	16,00	60,00	54,00	4,50	45,00	4,50			3,87
		TL-SH35-14M-40TB	14,00	40,00	155,97	35	6F	2517	153,18	173,00	16,00	60,00	54,00	4,50	45,00	4,50			4,34
		TL-SH36-14M-40TB	14,00	40,00	160,43	36	6F	2517	157,68	173,00	16,00	60,00	54,00	4,50	45,00	4,50			4,62
		TL-SH38-14M-40TB	14,00	40,00	169,34	38	6F	2517	166,60	182,00	16,00	60,00	54,00	4,50	45,00	4,50			5,40
		TL-SH40-14M-40TB	14,00	40,00	178,25	40	6F	2517	175,49	191,00	16,00	60,00	54,00	4,50	45,00	4,50			6,23
		TL-SH42-14M-40TB	14,00	40,00	187,17	42	6F	2517	184,37	209,00	16,00	60,00	54,00	4,50	45,00	4,50			6,75
		TL-SH44-14M-40TB	14,00	40,00	196,08	44	6F	3020	193,28	209,00	25,00	75,00	54,00	1,50	51,00	1,50			7,26
		TL-SH45-14M-40TB	14,00	40,00	200,54	45	6F	3020	197,74	227,00	25,00	75,00	54,00	1,50	51,00	1,50			8,20
		TL-SH48-14M-40TB	14,00	40,00	213,90	48	6F	3020	211,11	227,00	25,00	75,00	54,00	1,50	51,00	1,50			9,33
		TL-SH50-14M-40TB	14,00	40,00	222,82	50	6F	3020	220,02	246,00	25,00	75,00	54,00	1,50	51,00	1,50			10,10
		TL-SH56-14M-40TB	14,00	40,00	249,55	56	6F	3020	246,76	264,00	25,00	75,00	54,00	1,50	51,00	1,50			10,80
		TL-SH60-14M-40TB	14,00	40,00	267,38	60	7F	3020	264,59	281,00	25,00	75,00	54,00	1,50	51,00	1,50	170,00		13,10
		TL-SH64-14M-40TB	14,00	40,00	285,21	64	7F	3020	282,41	296,00	25,00	75,00	54,00	1,50	51,00	1,50	170,00		15,40
		TL-SH72-14M-40TB	14,00	40,00	320,86	72	7N	3020	318,06		25,00	75,00	54,00	1,50	51,00	1,50	170,00		19,75
		TL-SH80-14M-40TB	14,00	40,00	356,51	80	8N	3020	353,71		25,00	75,00	54,00	1,50	51,00	1,50	170,00		20,00
		TL-SH90-14M-40TB	14,00	40,00	401,07	90	8N	3020	398,28		25,00	75,00	54,00	1,50	51,00	1,50	170,00		21,80
		TL-SH112-14M-40TB	14,00	40,00	499,11	112	8N	3020	496,32		25,00	75,00	54,00	1,50	51,00	1,50	170,00		29,60
		TL-SH144-14M-40TB	14,00	40,00	641,71	144	8N	3020	638,92		25,00	75,00	54,00	1,50	51,00	1,50	170,00		36,00
		TL-SH168-14M-40TB	14,00	40,00	748,66	168	8N	3020	745,87		25,00	75,00	54,00	1,50	51,00	1,50	170,00		48,00

NEXT >

TYPE 2F

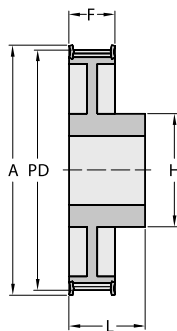

TYPE 3F

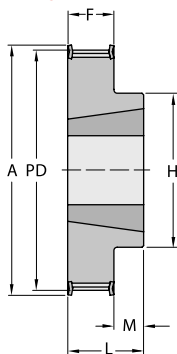

TYPE 4F

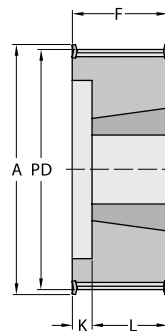

TYPE 6F

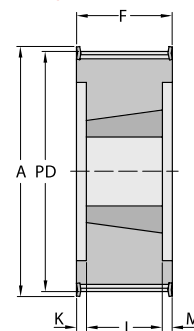

TYPE 7F

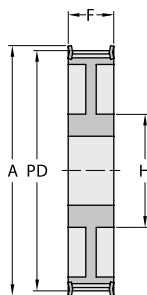

TYPE 10N

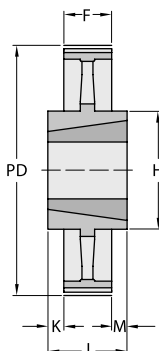

TYPE 12N

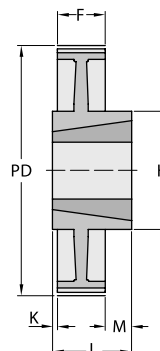

TYPE 12F

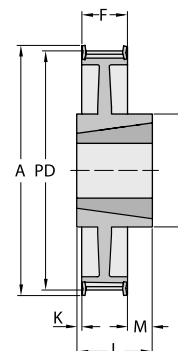

PROFILE	BELT WIDTH	REFERENCE	PITCH	BELT WIDTH	PITCH DIA PD	NO. TEETH	PULLEY TYPE	BUSH TYPE	OUTER DIA	A	BORE		F	K	L	M	H	WEIGHT
											mm	Min mm						
		TL-SH32-14M-115TB	14,00	115,00	142,60	32	6F	2517	139,88	156,00	16,00	60,00	133,00	44,00	45,00	44,00		6,00
		TL-SH34-14M-115TB	14,00	115,00	151,52	34	6F	2517	148,79	165,00	16,00	60,00	133,00	44,00	45,00	44,00		7,20
		TL-SH35-14M-115TB	14,00	115,00	155,97	35	6F	3020	153,18	173,00	25,00	75,00	133,00	41,00	51,00	41,00		7,00
		TL-SH36-14M-115TB	14,00	115,00	160,43	36	6F	3020	157,68	173,00	25,00	75,00	133,00	41,00	51,00	41,00		7,30
		TL-SH38-14M-115TB	14,00	115,00	169,34	38	6F	3020	166,60	182,00	25,00	75,00	133,00	41,00	51,00	41,00		8,40
		TL-SH40-14M-115TB	14,00	115,00	178,25	40	6F	3020	175,49	191,00	25,00	75,00	133,00	41,00	51,00	41,00		9,20
		TL-SH42-14M-115TB	14,00	115,00	187,17	42	6F	3030	184,37	209,00	35,00	75,00	133,00	28,50	76,00	28,50		11,60
		TL-SH44-14M-115TB	14,00	115,00	196,08	44	6F	3030	193,28	209,00	35,00	75,00	133,00	28,50	76,00	28,50		14,00
		TL-SH45-14M-115TB	14,00	115,00	200,54	45	6F	3030	197,74	227,00	35,00	75,00	133,00	28,50	76,00	28,50		15,60
		TL-SH48-14M-115TB	14,00	115,00	213,90	48	6F	3030	211,11	227,00	35,00	75,00	133,00	28,50	76,00	28,50		17,10
		TL-SH50-14M-115TB	14,00	115,00	222,82	50	6F	3535	220,02	246,00	35,00	90,00	133,00	22,00	89,00	22,00		21,00
		TL-SH56-14M-115TB	14,00	115,00	249,55	56	6F	3535	246,76	264,00	35,00	90,00	133,00	22,00	89,00	22,00		24,80
		TL-SH60-14M-115TB	14,00	115,00	267,38	60	6F	3535	264,59	281,00	35,00	90,00	133,00	22,00	89,00	22,00		25,90
		TL-SH64-14M-115TB	14,00	115,00	285,21	64	7F	3535	282,41	298,00	35,00	90,00	133,00	22,00	89,00	22,00	190,00	27,00
		TL-SH72-14M-115TB	14,00	115,00	320,86	72	7N	3535	318,06		35,00	90,00	133,00	22,00	89,00	22,00	190,00	33,00
		TL-SH80-14M-115TB	14,00	115,00	356,51	80	7N	3535	353,71		35,00	90,00	133,00	22,00	89,00	22,00	190,00	37,00
		TL-SH90-14M-115TB	14,00	115,00	401,07	90	7N	3535	398,28		35,00	90,00	133,00	22,00	89,00	22,00	190,00	42,00
		TL-SH112-14M-115TB	14,00	115,00	499,11	112	8N	3535	496,32		35,00	90,00	133,00	22,00	89,00	22,00	190,00	56,00
		TL-SH144-14M-115TB	14,00	115,00	641,71	144	8N	4040	638,92		40,00	100,00	133,00	15,50	102,00	15,50	230,00	75,00
		TL-SH168-14M-115TB	14,00	115,00	748,66	168	8N	4040	745,87		40,00	100,00	133,00	15,50	102,00	15,50	230,00	92,60
		TL-SH192-14M-115TB	14,00	115,00	855,62	192	8N	4040	852,92		40,00	100,00	133,00	15,50	102,00	15,50	230,00	230,00
		TL-SH216-14M-115TB	14,00	115,00	962,56	216	8N	4040	959,76		40,00	100,00	133,00	15,50	102,00	15,50	230,00	127,00
14M	170	TL-SH35-14M-170TB	14,00	170,00	155,97	35	6F	3030	153,18	173,00	35,00	75,00	187,00	55,50	76,00	55,50		10,60
		TL-SH36-14M-170TB	14,00	170,00	160,43	36	6F	3030	157,68	173,00	35,00	75,00	187,00	55,50	76,00	55,50		11,20
		TL-SH38-14M-170TB	14,00	170,00	169,34	38	6F	3030	167,00	182,00	35,00	75,00	187,00	55,50	76,00	55,50		11,70
		TL-SH40-14M-170TB	14,00	170,00	178,25	40	6F	3030	175,00	191,00	35,00	75,00	187,00	55,50	76,00	55,50		13,00
		TL-SH42-14M-170TB	14,00	170,00	187,17	42	6F	3535	184,37	202,00	35,00	90,00	187,00	49,00	89,00	49,00		14,00
		TL-SH44-14M-170TB	14,00	170,00	196,08	44	6F	3535	193,00	209,00	35,00	90,00	187,00	49,00	89,00	49,00		15,00
		TL-SH45-14M-170TB	14,00	170,00	200,54	45	6F	3535	197,74	212,00	35,00	90,00	187,00	49,00	89,00	49,00		16,00
		TL-SH48-14M-170TB	14,00	170,00	213,90	48	6F	3535	211,00	227,00	35,00	90,00	187,00	49,00	89,00	49,00		19,00
		TL-SH50-14M-170TB	14,00	170,00	222,82	50	6F	3535	220,02	246,00	35,00	90,00	187,00	49,00	89,00	49,00		23,80
		TL-SH56-14M-170TB	14,00	170,00	249,55	56	6F	3535	247,00	263,00	35,00	90,00	187,00	49,00	89,00	49,00		28,50
		TL-SH60-14M-170TB	14,00	170,00	267,38	60	6F	4040	264,59	281,00	40,00	100,00	187,00	42,50	114,00	42,50		34,80
		TL-SH64-14M-170TB	14,00	170,00	285,21	64	6F	4040	282,00	298,00	40,00	100,00	187,00	42,50	114,00	42,50	230,00	41,00
		TL-SH72-14M-170TB	14,00	170,00	320,86	72	7N	4040	318,00		40,00	100,00	187,00	42,50	114,00	42,50	230,00	46,90
		TL-SH80-14M-170TB	14,00	170,00	356,51	80	7N	4040	354,00		40,00	100,00	187,00	42,50	114,00	42,50	230,00	48,00
		TL-SH90-14M-170TB	14,00	170,00	401,07	90	7N	4040	398,00		40,00	100,00	187,00	42,50	114,00	42,50	230,00	52,50
		TL-SH112-14M-170TB	14,00	170,00	499,11	112	7N	5050	496,00		70,00	125,00	187,00	30,00	127,00	30,00	242,00	74,50
		TL-SH144-14M-170TB	14,00	170,00	641,71	144	8N	5050	639,00		70,00	125,00	187,00	30,00	127,00	30,00	394,00	91,00
		TL-SH168-14M-170TB	14,00	170,00	748,66	168	8N	5050	746,00		70,00	125,00	187,00	30,00	127,00	30,00	394,00	116,00
		TL-SH192-14M-170TB	14,00	170,00	855,62	192	8N	5050	853,00		70,00	125,00	187,00	30,00	127,00	30,00	394,00	134,00
		TL-SH216-14M-170TB	14,00	170,00	962,57	216	8N	5050	960,00		70,00	125,00	187,00	30,00	127,00	30,00	394,00	146,50

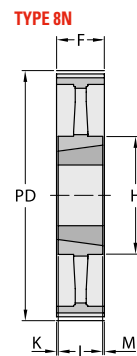
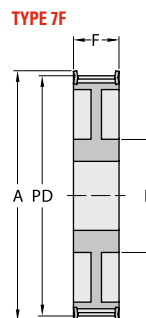
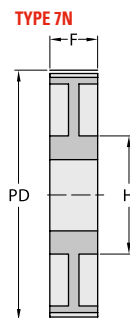
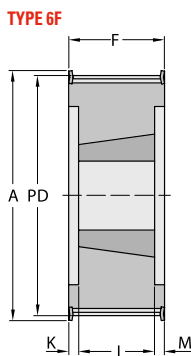

TIMING PULLEYS METRIC. PROFILE T2.5, T5, T10. RSB

PROFILE	PITCH	BELT WIDTH
	mm	mm
T2.5	2,50	4,00
		6,00
		10,00
T5	5,00	10,00
		16,00
		25,00
T10	10,00	16,00
		25,00
		32,00
		50,00



T2.5 Profile Timing Belt

Reference nomenclature: An alphanumeric string with blocks designating the product family SH, the number of teeth, the belt section matching the Timing Pulley profile, the width expressed in mm, the fixing mode of the pulley to shaft and finally a block indicating an specific requirement if any.

PROFILE T2.5, T5, T10. RSB

PROFILE	BELT WIDTH	REFERENCE	PITCH	BELT WIDTH	PITCH DIA PD	NO. TEETH	PULLEY TYPE	OUTER DIA	A		BORE		H	F	L	WEIGHT
									mm	mm	Min mm	Max mm				
T2.5	04 & 06	TL-SH10-T2.5-06RSB	2,50	6,00	7,96	10	OF	7,45	10,00		3,00	10,00	10,00	16,00	0,001	
		TL-SH11-T2.5-06RSB	2,50	6,00	8,75	11	OF	8,25	12,00		3,00	11,00	10,00	16,00	0,002	
		TL-SH12-T2.5-06RSB	2,50	6,00	9,54	12	OF	9,00	13,00		4,00	13,00	10,00	16,00	0,003	
		TL-SH13-T2.5-06RSB	2,50	6,00	10,35	13	OF	9,95	14,00		4,00	14,00	10,00	16,00	0,004	
		TL-SH14-T2.5-06RSB	2,50	6,00	11,14	14	OF	10,60	15,00		5,00	15,00	10,00	16,00	0,004	
		TL-SH15-T2.5-06RSB	2,50	6,00	11,94	15	OF	11,40	15,00		6,00	15,00	10,00	16,00	0,010	
		TL-SH16-T2.5-06RSB	2,50	6,00	12,73	16	OF	12,20	16,00		7,00	16,00	10,00	16,00	0,005	
		TL-SH17-T2.5-06RSB	2,50	6,00	13,53	17	OF	13,00	17,00	4,00	7,00	16,00	10,00	16,00	0,006	
		TL-SH18-T2.5-06RSB	2,50	6,00	14,32	18	1F	13,80	18,00	4,00	7,00	10,00	10,00	16,00	0,006	
		TL-SH19-T2.5-06RSB	2,50	6,00	15,12	19	1F	14,60	18,00	4,00	7,00	10,00	10,00	16,00	0,007	
		TL-SH20-T2.5-06RSB	2,50	6,00	15,92	20	1F	15,40	20,00	4,00	7,00	11,00	10,00	16,00	0,008	
		TL-SH21-T2.5-06RSB	2,50	6,00	16,71	21	1F	16,20	20,00	4,00	7,00	11,00	10,00	16,00	0,009	
		TL-SH22-T2.5-06RSB	2,50	6,00	17,51	22	1F	17,00	23,00	4,00	7,00	11,00	10,00	16,00	0,009	
		TL-SH23-T2.5-06RSB	2,50	6,00	18,30	23	1F	17,80	23,00	4,00	8,00	12,00	10,00	16,00	0,010	
		TL-SH24-T2.5-06RSB	2,50	6,00	19,10	24	1F	18,55	23,00	4,00	8,00	12,00	10,00	16,00	0,012	
		TL-SH25-T2.5-06RSB	2,50	6,00	19,89	25	1F	19,35	23,00	4,00	9,00	13,00	10,00	16,00	0,013	
		TL-SH26-T2.5-06RSB	2,50	6,00	20,69	26	1F	20,15	25,00	4,00	9,00	14,00	10,00	16,00	0,014	
		TL-SH27-T2.5-06RSB	2,50	6,00	21,49	27	1F	20,90	25,00	4,00	9,00	14,00	10,00	16,00	0,015	
		TL-SH28-T2.5-06RSB	2,50	6,00	22,28	28	1F	21,75	25,00	4,00	9,00	14,00	10,00	16,00	0,016	
		TL-SH30-T2.5-06RSB	2,50	6,00	23,87	30	1F	23,35	28,00	6,00	10,00	16,00	10,00	16,00	0,018	
		TL-SH32-T2.5-06RSB	2,50	6,00	25,46	32	1F	24,95	32,00	6,00	10,00	16,00	10,00	16,00	0,020	
		TL-SH35-T2.5-06RSB	2,50	6,00	27,85	35	1F	27,35	36,00	6,00	10,00	18,00	10,00	16,00	0,024	
		TL-SH36-T2.5-06RSB	2,50	6,00	28,65	36	1F	28,10	36,00	6,00	13,00	20,00	10,00	16,00	0,026	
		TL-SH38-T2.5-06RSB	2,50	6,00	30,24	38	1F	31,70	38,00	6,00	13,00	22,00	10,00	16,00	0,029	
		TL-SH40-T2.5-06RSB	2,50	6,00	31,83	40	1F	31,30	38,00	6,00	13,00	22,00	10,00	16,00	0,032	
		TL-SH42-T2.5-06RSB	2,50	6,00	33,42	42	1F	32,90	42,00	6,00	15,00	24,00	10,00	16,00	0,036	
		TL-SH44-T2.5-06RSB	2,50	6,00	35,01	44	1N	34,50		6,00	15,00	24,00	10,00	16,00	0,040	
		TL-SH45-T2.5-06RSB	2,50	6,00	35,81	45	1N	35,30		6,00	17,00	26,00	10,00	16,00	0,044	
		TL-SH48-T2.5-06RSB	2,50	6,00	38,20	48	1N	37,70		6,00	17,00	26,00	10,00	16,00	0,048	
		TL-SH54-T2.5-06RSB	2,50	6,00	42,97	54	1N	42,45		8,00	19,00	30,00	10,00	16,00	0,056	
		TL-SH57-T2.5-06RSB	2,50	6,00	45,36	57	1N	44,85		8,00	19,00	32,00	10,00	16,00	0,064	

NEXT >

PROFILE	BELT WIDTH	REFERENCE	PITCH	BELT WIDTH	PITCH DIA PD	NO. TEETH	PULLEY TYPE	OUTER DIA	A		BORE		H	F	L	WEIGHT
									mm	mm	Min mm	Max mm				
		TL-SH60-T2.5-06RSB	2,50	6,00	47,75	60	1N	47,25			8,00	22,00	34,00	10,00	16,00	0,073
T2.5	10,00	TL-SH10-T2.5-10RSB	2,50	10,00	7,96	10	OF	7,45	10,00	3,00	3,00	10,00	14,00	20,00	0,010	
		TL-SH11-T2.5-10RSB	2,50	10,00	8,75	11	OF	8,25	12,00	3,00	3,00	11,00	14,00	20,00	0,010	
		TL-SH12-T2.5-10RSB	2,50	10,00	9,55	12	OF	9,00	13,00	3,00	4,00	13,00	14,00	20,00	0,020	
		TL-SH13-T2.5-10RSB	2,50	10,00	10,35	13	OF	9,95	14,00	3,00	4,00	14,00	14,00	20,00	0,020	
		TL-SH14-T2.5-10RSB	2,50	10,00	11,14	14	OF	10,60	14,00	3,00	5,00	15,00	14,00	20,00	0,020	
		TL-SH15-T2.5-10RSB	2,50	10,00	11,94	15	OF	11,40	15,00	3,00	6,00	15,00	14,00	20,00	0,020	
		TL-SH16-T2.5-10RSB	2,50	10,00	12,73	16	OF	12,20	16,00	4,00	7,00	16,00	14,00	20,00	0,030	
		TL-SH17-T2.5-10RSB	2,50	10,00	13,53	17	1F	13,00	17,00	4,00	7,00	16,00	14,00	20,00	0,020	
		TL-SH18-T2.5-10RSB	2,50	10,00	14,32	18	1F	13,80	17,00	4,00	7,00	10,00	14,00	20,00	0,030	
		TL-SH19-T2.5-10RSB	2,50	10,00	15,12	19	1F	14,60	18,00	4,00	7,00	10,00	14,00	20,00	0,040	
		TL-SH20-T2.5-10RSB	2,50	10,00	15,92	20	1F	15,40	19,00	4,00	7,00	11,00	14,00	20,00	0,040	
		TL-SH21-T2.5-10RSB	2,50	10,00	16,71	21	1F	16,20	20,00	4,00	7,00	11,00	14,00	20,00	0,040	
		TL-SH22-T2.5-10RSB	2,50	10,00	17,60	22	1F	17,00	22,00	4,00	7,00	11,00	14,00	20,00	0,050	
		TL-SH23-T2.5-10RSB	2,50	10,00	18,30	23	1F	17,80	22,00	4,00	8,00	12,00	14,00	20,00	0,050	
		TL-SH24-T2.5-10RSB	2,50	10,00	19,10	24	1F	18,55	22,00	4,00	8,00	12,00	14,00	20,00	0,050	
		TL-SH25-T2.5-10RSB	2,50	10,00	19,89	25	1F	19,35	24,00	4,00	9,00	13,00	14,00	20,00	0,060	
		TL-SH26-T2.5-10RSB	2,50	10,00	20,75	26	1F	20,15	26,00	4,00	9,00	14,00	14,00	20,00	0,060	
		TL-SH27-T2.5-10RSB	2,50	10,00	21,49	27	1F	20,90	26,00	4,00	9,00	14,00	14,00	20,00	0,060	
		TL-SH28-T2.5-10RSB	2,50	10,00	22,35	28	1F	21,75	26,00	4,00	9,00	14,00	14,00	20,00	0,070	
		TL-SH30-T2.5-10RSB	2,50	10,00	23,87	30	1F	23,35	28,00	6,00	10,00	16,00	14,00	20,00	0,080	
		TL-SH32-T2.5-10RSB	2,50	10,00	25,47	32	1F	24,95	28,00	6,00	10,00	16,00	14,00	20,00	0,090	
		TL-SH35-T2.5-10RSB	2,50	10,00	27,85	35	1F	27,35	32,00	6,00	10,00	18,00	14,00	20,00	0,110	
		TL-SH36-T2.5-10RSB	2,50	10,00	28,65	36	1F	28,10	32,00	6,00	13,00	20,00	14,00	20,00	0,110	
		TL-SH38-T2.5-10RSB	2,50	10,00	30,24	38	1F	30,70	34,00	6,00	13,00	22,00	14,00	20,00	0,130	
		TL-SH40-T2.5-10RSB	2,50	10,00	31,83	40	1F	31,30	35,00	6,00	13,00	22,00	14,00	20,00	0,140	
		TL-SH42-T2.5-10RSB	2,50	10,00	33,42	42	1N	32,90		6,00	15,00	24,00	14,00	20,00	0,180	
		TL-SH44-T2.5-10RSB	2,50	10,00	35,01	44	1N	34,50		6,00	15,00	24,00	14,00	20,00	0,190	
TL-SH45-T2.5-10RSB	2,50	10,00	35,81	45	1N	35,30		6,00	17,00	26,00	14,00	20,00	0,190			
TL-SH48-T2.5-10RSB	2,50	10,00	38,20	48	1N	37,70		6,00	17,00	26,00	14,00	20,00	0,200			
TL-SH54-T2.5-10RSB	2,50	10,00	42,97	54	1N	42,45		8,00	19,00	30,00	14,00	20,00	0,250			
TL-SH57-T2.5-10RSB	2,50	10,00	45,36	57	1N	44,85		8,00	19,00	32,00	14,00	20,00	0,280			
TL-SH60-T2.5-10RSB	2,50	10,00	47,75	60	1N	47,25		8,00	22,00	34,00	14,00	20,00	0,310			
T5	10,00	TL-SH10-T5-10RSB	5,00	10,00	15,92	10	1F	15,05	20,00	4,00	5,00	8,00	15,00	21,00	0,010	
		TL-SH11-T5-10RSB	5,00	10,00	17,51	11	1F	16,65	22,00	4,00	6,00	10,00	15,00	21,00	0,010	
		TL-SH12-T5-10RSB	5,00	10,00	19,10	12	1F	18,25	23,00	4,00	7,00	12,00	15,00	21,00	0,020	
		TL-SH13-T5-10RSB	5,00	10,00	20,69	13	1F	19,85	25,00	6,00	8,00	13,00	15,00	21,00	0,020	
		TL-SH14-T5-10RSB	5,00	10,00	22,29	14	1F	21,45	26,00	6,00	9,00	14,00	15,00	21,00	0,020	
		TL-SH15-T5-10RSB	5,00	10,00	23,88	15	1F	23,05	28,00	6,00	10,00	16,00	15,00	21,00	0,020	
		TL-SH16-T5-10RSB	5,00	10,00	25,47	16	1F	24,60	30,00	6,00	11,00	18,00	15,00	21,00	0,030	
		TL-SH17-T5-10RSB	5,00	10,00	27,06	17	1F	26,20	32,00	6,00	12,00	19,00	15,00	21,00	0,030	
		TL-SH18-T5-10RSB	5,00	10,00	28,65	18	1F	27,80	32,00	6,00	13,00	20,00	15,00	21,00	0,030	
TL-SH19-T5-10RSB	5,00	10,00	30,25	19	1F	29,40	36,00	6,00	14,00	22,00	15,00	21,00	0,040			

NEXT >

TYPE OF

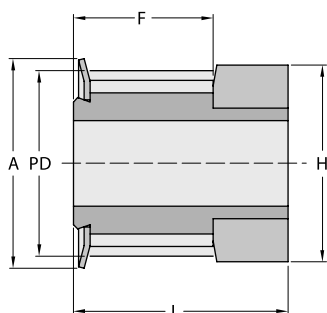

TYPE 1N

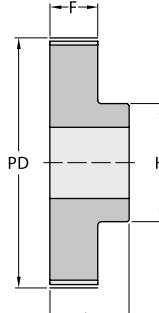

TYPE 1F

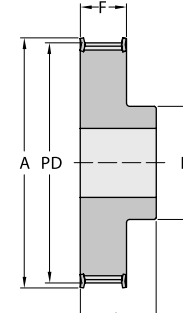

PROFILE T2.5, T5, T10. RSB

PROFILE	BELT WIDTH	REFERENCE	PITCH	BELT WIDTH	PITCH DIA PD	NO. TEETH	PULLEY TYPE	OUTER DIA	A		BORE		H	F	L	WEIGHT
									mm		Min mm	Max mm				
		TL-SH20-T5-10RSB	5,00	10,00	31,83	20	1F	31,00	36,00	6,00	15,00	24,00	15,00	21,00	0,040	
		TL-SH21-T5-10RSB	5,00	10,00	33,42	21	1F	32,55	38,00	6,00	15,00	24,00	15,00	21,00	0,040	
		TL-SH22-T5-10RSB	5,00	10,00	35,01	22	1F	34,15	38,00	6,00	15,00	24,00	15,00	21,00	0,050	
		TL-SH23-T5-10RSB	5,00	10,00	36,61	23	1F	35,75	42,00	6,00	16,00	25,00	15,00	21,00	0,050	
		TL-SH24-T5-10RSB	5,00	10,00	38,21	24	1F	37,40	44,00	6,00	17,00	26,00	15,00	21,00	0,050	
		TL-SH25-T5-10RSB	5,00	10,00	39,80	25	1F	38,95	44,00	6,00	17,00	26,00	15,00	21,00	0,060	
		TL-SH26-T5-10RSB	5,00	10,00	41,45	26	1F	40,60	44,00	6,00	17,00	26,00	15,00	21,00	0,060	
		TL-SH27-T5-10RSB	5,00	10,00	42,98	27	1F	42,20	48,00	8,00	19,00	30,00	15,00	21,00	0,060	
		TL-SH28-T5-10RSB	5,00	10,00	44,56	28	1F	43,75	48,00	8,00	20,00	32,00	15,00	21,00	0,060	
		TL-SH30-T5-10RSB	5,00	10,00	47,76	30	1F	46,95	51,00	8,00	22,00	34,00	15,00	21,00	0,080	
		TL-SH32-T5-10RSB	5,00	10,00	50,94	32	1F	50,10	54,00	8,00	24,00	38,00	15,00	21,00	0,090	
		TL-SH35-T5-10RSB	5,00	10,00	55,70	35	1F	54,85	59,00	8,00	24,00	38,00	15,00	21,00	0,100	
		TL-SH36-T5-10RSB	5,00	10,00	57,31	36	1F	56,45	63,00	8,00	24,00	38,00	15,00	21,00	0,110	
		TL-SH38-T5-10RSB	5,00	10,00	60,48	38	1F	59,65	66,00	8,00	26,00	40,00	15,00	21,00	0,130	
		TL-SH40-T5-10RSB	5,00	10,00	63,66	40	1F	62,85	66,00	8,00	26,00	40,00	15,00	21,00	0,140	
		TL-SH42-T5-10RSB	5,00	10,00	66,84	42	1F	66,00	71,00	8,00	26,00	40,00	15,00	21,00	0,180	
		TL-SH44-T5-10RSB	5,00	10,00	70,20	44	1N	69,35		8,00	29,00	45,00	15,00	21,00	0,190	
		TL-SH45-T5-10RSB	5,00	10,00	71,62	45	1N	70,80		8,00	31,00	45,00	15,00	21,00	0,190	
		TL-SH48-T5-10RSB	5,00	10,00	76,39	48	1N	75,55		8,00	32,00	50,00	15,00	21,00	0,200	
		TL-SH54-T5-10RSB	5,00	10,00	85,94	54	1N	85,10		8,00	35,00	55,00	15,00	21,00	0,240	
		TL-SH57-T5-10RSB	5,00	10,00	90,72	57	1N	89,90		8,00	38,00	60,00	15,00	21,00	0,270	
		TL-SH60-T5-10RSB	5,00	10,00	95,49	60	1N	94,65		8,00	42,00	65,00	15,00	21,00	0,310	
T5	16,00	TL-SH10-T5-16RSB	5,00	16,00	15,92	10	1F	15,05	20,00	4,00	5,00	8,00	21,00	27,00	0,020	
		TL-SH11-T5-16RSB	5,00	16,00	17,51	11	1F	16,65	22,00	4,00	6,00	10,00	21,00	27,00	0,020	
		TL-SH12-T5-16RSB	5,00	16,00	19,10	12	1F	18,25	23,00	4,00	7,00	12,00	21,00	27,00	0,020	
		TL-SH13-T5-16RSB	5,00	16,00	20,69	13	1F	19,85	25,00	6,00	8,00	13,00	21,00	27,00	0,020	
		TL-SH14-T5-16RSB	5,00	16,00	22,29	14	1F	21,45	26,00	6,00	9,00	14,00	21,00	27,00	0,030	
		TL-SH15-T5-16RSB	5,00	16,00	23,88	15	1F	23,05	28,00	6,00	10,00	16,00	21,00	27,00	0,030	
		TL-SH16-T5-16RSB	5,00	16,00	25,47	16	1F	24,60	32,00	6,00	11,00	18,00	21,00	27,00	0,040	
		TL-SH17-T5-16RSB	5,00	16,00	27,06	17	1F	26,20	32,00	6,00	12,00	19,00	21,00	27,00	0,040	
		TL-SH18-T5-16RSB	5,00	16,00	28,65	18	1F	27,80	33,00	6,00	13,00	20,00	21,00	27,00	0,050	
		TL-SH19-T5-16RSB	5,00	16,00	30,25	19	1F	29,40	36,00	6,00	14,00	22,00	21,00	27,00	0,050	
		TL-SH20-T5-16RSB	5,00	16,00	31,83	20	1F	31,00	36,00	6,00	15,00	24,00	21,00	27,00	0,050	
		TL-SH21-T5-16RSB	5,00	16,00	33,42	21	1F	32,55	38,00	6,00	15,00	24,00	21,00	27,00	0,050	
		TL-SH22-T5-16RSB	5,00	16,00	35,01	22	1F	34,15	38,00	6,00	15,00	24,00	21,00	27,00	0,050	
		TL-SH23-T5-16RSB	5,00	16,00	36,61	23	1F	35,75	42,00	6,00	16,00	25,00	21,00	27,00	0,060	
		TL-SH24-T5-16RSB	5,00	16,00	38,21	24	1F	37,40	42,00	6,00	17,00	26,00	21,00	27,00	0,080	
		TL-SH25-T5-16RSB	5,00	16,00	39,80	25	1F	38,95	44,00	6,00	17,00	26,00	21,00	27,00	0,080	
		TL-SH26-T5-16RSB	5,00	16,00	41,45	26	1F	40,60	44,00	6,00	17,00	26,00	21,00	27,00	0,090	
		TL-SH27-T5-16RSB	5,00	16,00	42,98	27	1F	42,20	48,00	8,00	19,00	30,00	21,00	27,00	0,090	
		TL-SH28-T5-16RSB	5,00	16,00	44,56	28	1F	43,75	48,00	8,00	20,00	32,00	21,00	27,00	0,090	
		TL-SH30-T5-16RSB	5,00	16,00	47,76	30	1F	46,95	51,00	8,00	22,00	34,00	21,00	27,00	0,110	
		TL-SH32-T5-16RSB	5,00	16,00	50,94	32	1F	50,10	54,00	8,00	24,00	38,00	21,00	27,00	0,120	
		TL-SH35-T5-16RSB	5,00	16,00	55,70	35	1F	54,85	59,00	8,00	24,00	38,00	21,00	27,00	0,140	
		TL-SH36-T5-16RSB	5,00	16,00	57,31	36	1F	56,45	63,00	8,00	24,00	38,00	21,00	27,00	0,160	
		TL-SH38-T5-16RSB	5,00	16,00	60,48	38	1F	59,65	66,00	8,00	26,00	40,00	21,00	27,00	0,180	
		TL-SH40-T5-16RSB	5,00	16,00	63,66	40	1F	62,85	66,00	8,00	26,00	40,00	21,00	27,00	0,190	
		TL-SH42-T5-16RSB	5,00	16,00	66,84	42	1F	66,00	71,00	8,00	26,00	40,00	21,00	27,00	0,210	
		TL-SH44-T5-16RSB	5,00	16,00	70,20	44	1N	69,35		8,00	29,00	45,00	21,00	27,00	0,230	
		TL-SH45-T5-16RSB	5,00	16,00	71,62	45	1N	70,80		8,00	29,00	45,00	21,00	27,00	0,260	
		TL-SH48-T5-16RSB	5,00	16,00	76,39	48	1N	75,55		8,00	32,00	50,00	21,00	27,00	0,280	
		TL-SH54-T5-16RSB	5,00	16,00	85,94	54	1N	85,10		8,00	35,00	55,00	21,00	27,00	0,330	
		TL-SH57-T5-16RSB	5,00	16,00	90,72	57	1N	89,90		8,00	38,00	60,00	21,00	27,00	0,380	
		TL-SH60-T5-16RSB	5,00	16,00	95,49	60	1N	94,65		8,00	42,00	65,00	21,00	27,00	0,430	

NEXT >

PROFILE	BELT WIDTH	REFERENCE	PITCH	BELT WIDTH	PITCH DIA PD	NO. TEETH	PULLEY TYPE	OUTER DIA	A	BORE		H	F	L	WEIGHT
									mm	Min mm	Max mm				
T5	25,00	TL-SH10-T5-25RSB	5,00	25,00	15,92	10	1F	15,05	20,00	4,00	5,00	8,00	30,00	36,00	0,020
		TL-SH11-T5-25RSB	5,00	25,00	17,51	11	1F	16,65	22,00	4,00	6,00	10,00	30,00	36,00	0,030
		TL-SH12-T5-25RSB	5,00	25,00	19,10	12	1F	18,25	23,00	4,00	7,00	12,00	30,00	36,00	0,030
		TL-SH13-T5-25RSB	5,00	25,00	20,69	13	1F	19,85	25,00	6,00	8,00	13,00	30,00	36,00	0,030
		TL-SH14-T5-25RSB	5,00	25,00	22,29	14	1F	21,45	26,00	6,00	9,00	14,00	30,00	36,00	0,040
		TL-SH15-T5-25RSB	5,00	25,00	23,88	15	1F	23,05	28,00	6,00	10,00	16,00	30,00	36,00	0,040
		TL-SH16-T5-25RSB	5,00	25,00	25,47	16	1F	24,60	32,00	6,00	11,00	18,00	30,00	36,00	0,050
		TL-SH17-T5-25RSB	5,00	25,00	27,06	17	1F	26,20	32,00	6,00	12,00	19,00	30,00	36,00	0,060
		TL-SH18-T5-25RSB	5,00	25,00	28,65	18	1F	27,80	32,00	6,00	13,00	20,00	30,00	36,00	0,060
		TL-SH19-T5-25RSB	5,00	25,00	30,25	19	1F	29,40	36,00	6,00	14,00	22,00	30,00	36,00	0,070
		TL-SH20-T5-25RSB	5,00	25,00	31,83	20	1F	31,00	36,00	6,00	15,00	24,00	30,00	36,00	0,080
		TL-SH21-T5-25RSB	5,00	25,00	33,42	21	1F	32,55	38,00	6,00	15,00	24,00	30,00	36,00	0,080
		TL-SH22-T5-25RSB	5,00	25,00	35,01	22	1F	34,15	38,00	6,00	15,00	24,00	30,00	36,00	0,080
		TL-SH23-T5-25RSB	5,00	25,00	36,61	23	1F	35,75	42,00	6,00	16,00	25,00	30,00	36,00	0,090
		TL-SH24-T5-25RSB	5,00	25,00	38,21	24	1F	37,40	42,00	6,00	17,00	26,00	30,00	36,00	0,110
		TL-SH25-T5-25RSB	5,00	25,00	39,80	25	1F	38,95	44,00	6,00	17,00	26,00	30,00	36,00	0,120
		TL-SH26-T5-25RSB	5,00	25,00	41,45	26	1F	40,60	44,00	6,00	17,00	26,00	30,00	36,00	0,120
		TL-SH27-T5-25RSB	5,00	25,00	42,98	27	1F	42,20	48,00	8,00	19,00	30,00	30,00	36,00	0,130
		TL-SH28-T5-25RSB	5,00	25,00	44,56	28	1F	43,75	48,00	8,00	20,00	32,00	30,00	36,00	0,130
		TL-SH30-T5-25RSB	5,00	25,00	47,76	30	1F	46,95	51,00	8,00	22,00	34,00	30,00	36,00	0,150
		TL-SH32-T5-25RSB	5,00	25,00	50,94	32	1F	50,10	54,00	8,00	24,00	38,00	30,00	36,00	0,180
		TL-SH35-T5-25RSB	5,00	25,00	55,70	35	1F	54,85	59,00	8,00	24,00	38,00	30,00	36,00	0,210
		TL-SH36-T5-25RSB	5,00	25,00	57,31	36	1F	56,45	63,00	8,00	24,00	38,00	30,00	36,00	0,230
		TL-SH38-T5-25RSB	5,00	25,00	60,48	38	1F	59,65	66,00	8,00	26,00	40,00	30,00	36,00	0,250
		TL-SH40-T5-25RSB	5,00	25,00	63,66	40	1F	62,85	66,00	8,00	26,00	40,00	30,00	36,00	0,280
		TL-SH42-T5-25RSB	5,00	25,00	66,84	42	1F	66,00	71,00	8,00	26,00	40,00	30,00	36,00	0,280
		TL-SH44-T5-25RSB	5,00	25,00	70,20	44	1N	69,35		8,00	29,00	45,00	30,00	36,00	0,320
		TL-SH45-T5-25RSB	5,00	25,00	71,62	45	1N	70,80		8,00	29,00	45,00	30,00	36,00	0,360
		TL-SH48-T5-25RSB	5,00	25,00	76,39	48	1N	75,55		8,00	32,00	50,00	30,00	36,00	0,400
		TL-SH54-T5-25RSB	5,00	25,00	85,94	54	1N	85,10		8,00	35,00	55,00	30,00	36,00	0,470
TL-SH57-T5-25RSB	5,00	25,00	90,72	57	1N	89,90		8,00	38,00	60,00	30,00	36,00	0,540		
TL-SH60-T5-25RSB	5,00	25,00	95,49	60	1N	94,65		8,00	42,00	65,00	30,00	36,00	0,610		
T10	16,00	TL-SH12-T10-16RSB	10,00	16,00	38,20	12	1F	36,35	42,00	6,00	18,00	28,00	21,00	31,00	0,080
		TL-SH13-T10-16RSB	10,00	16,00	41,38	13	1F	39,55	44,00	6,00	19,00	32,00	21,00	31,00	0,090
		TL-SH14-T10-16RSB	10,00	16,00	44,56	14	1F	42,70	48,00	8,00	21,00	32,00	21,00	31,00	0,100
		TL-SH15-T10-16RSB	10,00	16,00	47,75	15	1F	45,90	51,00	8,00	21,00	32,00	21,00	31,00	0,120
		TL-SH16-T10-16RSB	10,00	16,00	50,93	16	1F	49,10	54,00	8,00	23,00	35,00	21,00	31,00	0,130
		TL-SH17-T10-16RSB	10,00	16,00	54,11	17	1F	52,25	58,00	8,00	24,00	38,00	21,00	31,00	0,150
		TL-SH18-T10-16RSB	10,00	16,00	57,29	18	1F	55,45	60,00	8,00	26,00	40,00	21,00	31,00	0,170
		TL-SH19-T10-16RSB	10,00	16,00	60,48	19	1F	58,65	66,00	8,00	28,00	44,00	21,00	31,00	0,180
		TL-SH20-T10-16RSB	10,00	16,00	63,66	20	1F	61,80	66,00	8,00	30,00	46,00	21,00	31,00	0,210
		TL-SH21-T10-16RSB	10,00	16,00	66,85	21	1F	65,00	71,00	8,00	36,00	48,00	21,00	31,00	0,230
		TL-SH22-T10-16RSB	10,00	16,00	70,03	22	1F	68,20	75,00	8,00	34,00	52,00	21,00	31,00	0,250
		TL-SH23-T10-16RSB	10,00	16,00	73,21	23	1F	71,35	77,00	8,00	36,00	55,00	21,00	31,00	0,270

NEXT >

TYPE OF

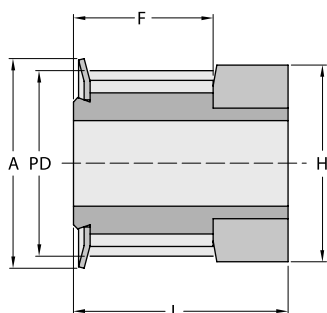

TYPE 1N

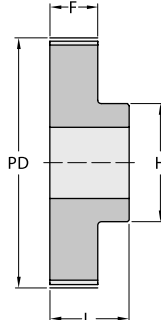

TYPE 1F

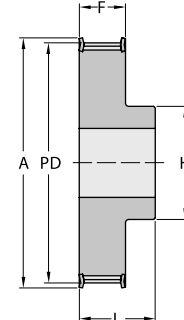

PROFILE	BELT WIDTH	REFERENCE	PITCH	BELT WIDTH	PITCH DIA PD	NO. TEETH	PULLEY TYPE	OUTER DIA	A	BORE		H	F	L	WEIGHT
									mm	Min mm	Max mm	mm	mm	mm	Kg
		TL-SH24-T10-16RSB	10,00	16,00	76,39	24	1F	74,55	83,00	8,00	38,00	58,00	21,00	31,00	0,290
		TL-SH25-T10-16RSB	10,00	16,00	79,58	25	1F	77,75	83,00	8,00	39,00	60,00	21,00	31,00	0,310
		TL-SH26-T10-16RSB	10,00	16,00	82,76	26	1F	80,90	87,00	8,00	39,00	60,00	21,00	31,00	0,360
		TL-SH27-T10-16RSB	10,00	16,00	85,95	27	1F	84,10	91,00	8,00	39,00	60,00	21,00	31,00	0,360
		TL-SH28-T10-16RSB	10,00	16,00	89,25	28	1F	87,25	93,00	8,00	39,00	60,00	21,00	31,00	0,400
		TL-SH30-T10-16RSB	10,00	16,00	95,49	30	1F	93,65	99,00	8,00	39,00	60,00	21,00	31,00	0,440
		TL-SH32-T10-16RSB	10,00	16,00	101,86	32	1F	100,00	106,00	10,00	42,00	65,00	21,00	31,00	0,490
		TL-SH35-T10-16RSB	10,00	16,00	111,41	35	1F	109,55	115,00	10,00	45,00	70,00	21,00	31,00	0,560
		TL-SH36-T10-16RSB	10,00	16,00	114,59	36	1F	112,75	119,00	10,00	45,00	70,00	21,00	31,00	0,620
		TL-SH38-T10-16RSB	10,00	16,00	120,96	38	1F	119,10	125,00	10,00	48,00	75,00	21,00	31,00	0,690
		TL-SH40-T10-16RSB	10,00	16,00	127,32	40	1F	125,45	131,00	10,00	52,00	80,00	21,00	31,00	0,770
		TL-SH42-T10-16RSB	10,00	16,00	133,69	42	1N	131,85		10,00	52,00	80,00	21,00	31,00	0,880
		TL-SH44-T10-16RSB	10,00	16,00	140,06	44	1N	138,20		10,00	57,00	88,00	21,00	31,00	0,990
		TL-SH45-T10-16RSB	10,00	16,00	143,24	45	1N	141,40		16,00	57,00	90,00	21,00	31,00	1,040
		TL-SH48-T10-16RSB	10,00	16,00	152,78	48	1N	150,95		16,00	62,00	95,00	21,00	31,00	1,090
		TL-SH54-T10-16RSB	10,00	16,00	171,89	54	1N	170,05		16,00	66,00	100,00	21,00	31,00	1,300
		TL-SH57-T10-16RSB	10,00	16,00	181,44	57	1N	179,60		16,00	66,00	110,00	21,00	31,00	1,500
		TL-SH60-T10-16RSB	10,00	16,00	190,98	60	1N	189,15		16,00	72,00	110,00	21,00	31,00	1,710
T10	25,00	TL-SH12-T10-25RSB	10,00	25,00	38,20	12	1F	36,35	42,00	6,00	18,00	28,00	30,00	40,00	0,100
		TL-SH13-T10-25RSB	10,00	25,00	41,38	13	1F	39,55	44,00	6,00	19,00	30,00	30,00	40,00	0,120
		TL-SH14-T10-25RSB	10,00	25,00	44,56	14	1F	42,70	48,00	8,00	21,00	32,00	30,00	40,00	0,130
		TL-SH15-T10-25RSB	10,00	25,00	47,75	15	1F	45,90	51,00	8,00	21,00	32,00	30,00	40,00	0,150
		TL-SH16-T10-25RSB	10,00	25,00	50,93	16	1F	49,10	54,00	8,00	23,00	35,00	30,00	40,00	0,180
		TL-SH17-T10-25RSB	10,00	25,00	54,11	17	1F	52,25	58,00	8,00	24,00	37,00	30,00	40,00	0,200
		TL-SH18-T10-25RSB	10,00	25,00	57,29	18	1F	55,45	60,00	8,00	26,00	40,00	30,00	40,00	0,220
		TL-SH19-T10-25RSB	10,00	25,00	60,48	19	1F	58,65	66,00	8,00	28,00	44,00	30,00	40,00	0,250
		TL-SH20-T10-25RSB	10,00	25,00	63,66	20	1F	61,80	66,00	8,00	30,00	46,00	30,00	40,00	0,280
		TL-SH21-T10-25RSB	10,00	25,00	66,85	21	1F	65,00	71,00	8,00	32,00	49,00	30,00	40,00	0,300
		TL-SH22-T10-25RSB	10,00	25,00	70,03	22	1F	68,20	75,00	8,00	34,00	52,00	30,00	40,00	0,340
		TL-SH23-T10-25RSB	10,00	25,00	73,21	23	1F	71,35	77,00	8,00	36,00	55,00	30,00	40,00	0,360
		TL-SH24-T10-25RSB	10,00	25,00	76,39	24	1F	74,55	83,00	8,00	38,00	58,00	30,00	40,00	0,390
		TL-SH25-T10-25RSB	10,00	25,00	79,58	25	1F	77,75	83,00	8,00	39,00	60,00	30,00	40,00	0,420
		TL-SH26-T10-25RSB	10,00	25,00	82,76	26	1F	80,90	87,00	8,00	39,00	60,00	30,00	40,00	0,480
		TL-SH27-T10-25RSB	10,00	25,00	85,95	27	1F	84,10	91,00	8,00	39,00	60,00	30,00	40,00	0,540
		TL-SH28-T10-25RSB	10,00	25,00	89,25	28	1F	87,25	93,00	8,00	39,00	60,00	30,00	40,00	0,540
		TL-SH30-T10-25RSB	10,00	25,00	95,49	30	1F	93,65	99,00	8,00	39,00	60,00	30,00	40,00	0,640
		TL-SH32-T10-25RSB	10,00	25,00	101,86	32	1F	100,00	106,00	10,00	42,00	65,00	30,00	40,00	0,690
		TL-SH35-T10-25RSB	10,00	25,00	111,41	35	1F	109,65	115,00	10,00	45,00	70,00	30,00	40,00	0,780
		TL-SH36-T10-25RSB	10,00	25,00	114,59	36	1F	112,75	119,00	10,00	45,00	70,00	30,00	40,00	0,870
		TL-SH38-T10-25RSB	10,00	25,00	120,96	38	1F	119,10	125,00	10,00	48,00	75,00	30,00	40,00	0,970
		TL-SH40-T10-25RSB	10,00	25,00	127,32	40	1F	125,45	131,00	10,00	52,00	80,00	30,00	40,00	1,070
		TL-SH42-T10-25RSB	10,00	25,00	133,69	42	1N	131,85		10,00	52,00	80,00	30,00	40,00	1,210
		TL-SH44-T10-25RSB	10,00	25,00	140,06	44	1N	138,20		10,00	57,00	88,00	30,00	40,00	1,350
		TL-SH45-T10-25RSB	10,00	25,00	143,24	45	1N	141,40		16,00	59,00	90,00	30,00	40,00	1,430
		TL-SH48-T10-25RSB	10,00	25,00	152,78	48	1N	150,95		16,00	62,00	95,00	30,00	40,00	1,520
		TL-SH54-T10-25RSB	10,00	25,00	171,89	54	1N	170,05		16,00	65,00	100,00	30,00	40,00	1,790
		TL-SH57-T10-25RSB	10,00	25,00	181,44	57	1N	179,60		16,00	72,00	110,00	30,00	40,00	2,060
		TL-SH60-T10-25RSB	10,00	25,00	190,98	60	1N	189,15		16,00	72,00	110,00	30,00	40,00	2,340
T10	32,00	TL-SH18-T10-32RSB	10,00	32,00	57,30	18	1F	55,45	60,00	10,00	26,00	40,00	37,00	47,00	0,250
		TL-SH19-T10-32RSB	10,00	32,00	60,48	19	1F	58,65	66,00	10,00	28,00	44,00	37,00	47,00	0,290
		TL-SH20-T10-32RSB	10,00	32,00	63,66	20	1F	61,80	66,00	12,00	30,00	46,00	37,00	47,00	0,320
		TL-SH21-T10-32RSB	10,00	32,00	66,85	21	1F	65,00	71,00	12,00	32,00	49,00	37,00	47,00	0,360
		TL-SH22-T10-32RSB	10,00	32,00	70,03	22	1F	68,20	75,00	12,00	34,00	52,00	37,00	47,00	0,390
		TL-SH23-T10-32RSB	10,00	32,00	73,21	23	1F	71,35	77,00	12,00	36,00	55,00	37,00	47,00	0,430
		TL-SH24-T10-32RSB	10,00	32,00	76,39	24	1F	74,55	83,00	12,00	38,00	58,00	37,00	47,00	0,480
		TL-SH25-T10-32RSB	10,00	32,00	79,58	25	1F	77,75	83,00	12,00	39,00	60,00	37,00	47,00	0,530

PROFILE	BELT WIDTH	REFERENCE	PITCH	BELT WIDTH	PITCH DIA PD	NO. TEETH	PULLEY TYPE	OUTER DIA	A		BORE		H	F	L	WEIGHT
									mm	mm	Min mm	Max mm				
		TL-SH26-T10-32RSB	10,00	32,00	82,76	26	1F	80,90	87,00	12,00	39,00	60,00	37,00	47,00	0,560	
		TL-SH27-T10-32RSB	10,00	32,00	85,94	27	1F	84,10	91,00	12,00	39,00	60,00	37,00	47,00	0,600	
		TL-SH28-T10-32RSB	10,00	32,00	89,13	28	1F	87,25	93,00	12,00	39,00	60,00	37,00	47,00	0,640	
		TL-SH30-T10-32RSB	10,00	32,00	95,49	30	1F	93,65	99,00	12,00	39,00	60,00	37,00	47,00	0,740	
		TL-SH32-T10-32RSB	10,00	32,00	101,86	32	1F	100,00	106,00	12,00	42,00	65,00	37,00	47,00	0,840	
		TL-SH35-T10-32RSB	10,00	32,00	111,41	35	1F	109,65	115,00	16,00	45,00	70,00	37,00	47,00	0,960	
		TL-SH36-T10-32RSB	10,00	32,00	114,59	36	1F	112,75	119,00	16,00	45,00	70,00	37,00	47,00	1,080	
		TL-SH38-T10-32RSB	10,00	32,00	120,96	38	1F	119,10	125,00	16,00	48,00	75,00	37,00	47,00	1,200	
		TL-SH40-T10-32RSB	10,00	32,00	127,32	40	1F	125,45	131,00	16,00	52,00	80,00	37,00	47,00	1,320	
		TL-SH42-T10-32RSB	10,00	32,00	133,69	42	1N	131,85		16,00	52,00	80,00	37,00	47,00	1,460	
		TL-SH44-T10-32RSB	10,00	32,00	140,06	44	1N	138,20		16,00	57,00	88,00	37,00	47,00	1,610	
		TL-SH45-T10-32RSB	10,00	32,00	143,24	45	1N	141,40		16,00	58,00	90,00	37,00	47,00	1,770	
		TL-SH48-T10-32RSB	10,00	32,00	152,78	48	1N	150,95		16,00	62,00	95,00	37,00	47,00	1,930	
		TL-SH54-T10-32RSB	10,00	32,00	171,89	54	1N	170,05		16,00	65,00	100,00	37,00	47,00	2,290	
		TL-SH57-T10-32RSB	10,00	32,00	181,44	57	1N	179,60		16,00	72,00	110,00	37,00	47,00	2,650	
		TL-SH60-T10-32RSB	10,00	32,00	190,99	60	1N	189,15		16,00	72,00	110,00	37,00	47,00	3,000	
T10	50	TL-SH18-T10-50RSB	10,00	50,00	57,30	18	1F	55,45	60,00	10,00	26,00	40,00	56,00	66,00	0,420	
		TL-SH19-T10-50RSB	10,00	50,00	60,48	19	1F	58,65	66,00	10,00	28,00	44,00	56,00	66,00	0,470	
		TL-SH20-T10-50RSB	10,00	50,00	63,66	20	1F	61,80	66,00	12,00	30,00	46,00	56,00	66,00	0,520	
		TL-SH21-T10-50RSB	10,00	50,00	66,85	21	1F	65,00	71,00	12,00	32,00	49,00	56,00	66,00	0,550	
		TL-SH22-T10-50RSB	10,00	50,00	70,03	22	1F	68,20	75,00	12,00	34,00	52,00	56,00	66,00	0,570	
		TL-SH23-T10-50RSB	10,00	50,00	73,21	23	1F	71,35	77,00	12,00	36,00	55,00	56,00	66,00	0,650	
		TL-SH24-T10-50RSB	10,00	50,00	76,39	24	1F	74,55	83,00	12,00	38,00	58,00	56,00	66,00	0,740	
		TL-SH25-T10-50RSB	10,00	50,00	79,58	25	1F	77,75	83,00	12,00	39,00	60,00	56,00	66,00	0,770	
		TL-SH26-T10-50RSB	10,00	50,00	82,76	26	1F	80,90	87,00	12,00	39,00	60,00	56,00	66,00	0,820	
		TL-SH27-T10-50RSB	10,00	50,00	85,94	27	1F	84,10	91,00	12,00	39,00	60,00	56,00	66,00	0,950	
		TL-SH28-T10-50RSB	10,00	50,00	89,13	28	1F	87,25	93,00	12,00	39,00	60,00	56,00	66,00	0,960	
		TL-SH30-T10-50RSB	10,00	50,00	95,49	30	1F	93,65	99,00	12,00	39,00	60,00	56,00	66,00	1,170	
		TL-SH32-T10-50RSB	10,00	50,00	101,86	32	1F	100,00	106,00	12,00	42,00	65,00	56,00	66,00	1,300	
		TL-SH35-T10-50RSB	10,00	50,00	111,41	35	1F	109,55	115,00	16,00	45,00	70,00	56,00	66,00	1,470	
		TL-SH36-T10-50RSB	10,00	50,00	114,59	36	1F	112,75	119,00	16,00	45,00	70,00	56,00	66,00	1,640	
		TL-SH38-T10-50RSB	10,00	50,00	120,96	38	1F	119,10	125,00	16,00	48,00	75,00	56,00	66,00	1,820	
		TL-SH40-T10-50RSB	10,00	50,00	127,32	40	1F	125,45	131,00	16,00	52,00	80,00	56,00	66,00	2,000	
		TL-SH42-T10-50RSB	10,00	50,00	133,69	42	1N	131,85		16,00	57,00	80,00	56,00	66,00	2,180	
		TL-SH44-T10-50RSB	10,00	50,00	140,06	44	1N	138,20		16,00	52,00	88,00	56,00	66,00	2,360	
		TL-SH45-T10-50RSB	10,00	50,00	143,24	45	1N	141,40		16,00	58,00	90,00	56,00	66,00	2,590	
		TL-SH48-T10-50RSB	10,00	50,00	152,78	48	1N	150,95		16,00	62,00	95,00	56,00	66,00	2,830	
		TL-SH54-T10-50RSB	10,00	50,00	171,89	54	1N	170,05		16,00	65,00	100,00	56,00	66,00	3,340	
		TL-SH57-T10-50RSB	10,00	50,00	181,44	57	1N	179,60		16,00	72,00	110,00	56,00	66,00	3,850	
		TL-SH60-T10-50RSB	10,00	50,00	190,99	60	1N	189,15		16,00	72,00	110,00	56,00	66,00	4,370	

TYPE OF

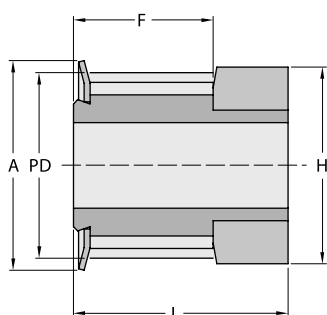

TYPE 1N

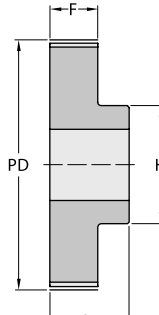

TYPE 1F

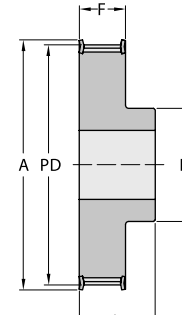

TIMING PULLEYS METRIC. PROFILE AT5, AT10. RSB

PROFILE	PITCH	BELT WIDTH
	mm	mm
AT5	5,00	10,00
		16,00
		25,00
AT10	10,00	16,00
		25,00
		32,00
		50,00



AT10 Profile Timing Belt

Reference nomenclature: An alphanumeric string with blocks designating the product family SH, the number of teeth, the belt section matching the Timing Pulley profile, the width expressed in mm, the

fixing mode of the pulley to shaft and finally a block indicating an specific requirement if any.

PROFILE AT5, AT10. RSB

PROFILE	BELT WIDTH	REFERENCE	PITCH	BELT WIDTH	PITCH DIA PD	NO. TEETH	PULLEY TYPE	OUTER DIA	A		BORE		H	F	L	WEIGHT
									mm	mm	Min mm	Max mm				
AT5	10,00	TL-SH10-AT5-10RSB	5,00	10,00	15,92	10	1F	14,65	20,00	4,00	5,00	8,00	15,00	21,00	0,010	
		TL-SH12-AT5-10RSB	5,00	10,00	19,10	12	1F	17,85	23,00	4,00	7,00	12,00	15,00	21,00	0,020	
		TL-SH13-AT5-10RSB	5,00	10,00	20,69	13	1F	19,45	25,00	6,00	8,00	13,00	15,00	21,00	0,020	
		TL-SH14-AT5-10RSB	5,00	10,00	22,29	14	1F	21,05	26,00	6,00	9,00	14,00	15,00	21,00	0,020	
		TL-SH15-AT5-10RSB	5,00	10,00	23,88	15	1F	22,65	28,00	6,00	10,00	16,00	15,00	21,00	0,020	
		TL-SH16-AT5-10RSB	5,00	10,00	25,47	16	1F	24,20	32,00	6,00	11,00	18,00	15,00	21,00	0,030	
		TL-SH17-AT5-10RSB	5,00	10,00	27,06	17	1F	25,80	32,00	6,00	12,00	19,00	15,00	21,00	0,030	
		TL-SH18-AT5-10RSB	5,00	10,00	28,65	18	1F	27,40	32,00	6,00	13,00	20,00	15,00	21,00	0,030	
		TL-SH19-AT5-10RSB	5,00	10,00	30,25	19	1F	29,00	36,00	6,00	14,00	22,00	15,00	21,00	0,040	
		TL-SH20-AT5-10RSB	5,00	10,00	31,83	20	1F	30,60	36,00	6,00	15,00	23,00	15,00	21,00	0,040	
		TL-SH21-AT5-10RSB	5,00	10,00	33,42	21	1F	32,20	38,00	6,00	15,00	24,00	15,00	21,00	0,040	
		TL-SH22-AT5-10RSB	5,00	10,00	35,02	22	1F	33,85	38,00	6,00	15,00	24,00	15,00	21,00	0,050	
		TL-SH23-AT5-10RSB	5,00	10,00	36,61	23	1F	35,40	42,00	6,00	17,00	25,00	15,00	21,00	0,050	
		TL-SH24-AT5-10RSB	5,00	10,00	38,21	24	1F	37,00	44,00	6,00	17,00	26,00	15,00	21,00	0,050	
		TL-SH25-AT5-10RSB	5,00	10,00	39,80	25	1F	38,60	44,00	6,00	17,00	26,00	15,00	21,00	0,060	
		TL-SH26-AT5-10RSB	5,00	10,00	41,38	26	1F	40,20	44,00	6,00	17,00	26,00	15,00	21,00	0,060	
		TL-SH27-AT5-10RSB	5,00	10,00	42,98	27	1F	41,80	48,00	8,00	19,00	30,00	15,00	21,00	0,060	
		TL-SH28-AT5-10RSB	5,00	10,00	44,56	28	1F	43,35	48,00	8,00	20,00	32,00	15,00	21,00	0,070	
		TL-SH30-AT5-10RSB	5,00	10,00	47,76	30	1F	46,55	51,00	8,00	22,00	34,00	15,00	21,00	0,080	
		TL-SH32-AT5-10RSB	5,00	10,00	50,94	32	1F	49,70	54,00	8,00	24,00	38,00	15,00	21,00	0,090	
		TL-SH36-AT5-10RSB	5,00	10,00	57,31	36	1F	56,05	63,00	8,00	24,00	38,00	15,00	21,00	0,110	
		TL-SH38-AT5-10RSB	5,00	10,00	60,48	38	1F	59,25	66,00	8,00	26,00	40,00	15,00	21,00	0,130	
		TL-SH40-AT5-10RSB	5,00	10,00	63,66	40	1F	62,45	66,00	8,00	26,00	40,00	15,00	21,00	0,140	
		TL-SH42-AT5-10RSB	5,00	10,00	66,74	42	1F	65,60	71,00	8,00	26,00	40,00	15,00	21,00	0,018	
		TL-SH44-AT5-10RSB	5,00	10,00	70,05	44	1N	68,80		8,00	29,00	45,00	15,00	21,00	0,190	
		TL-SH45-AT5-10RSB	5,00	10,00	71,62	45	1N	70,35		8,00	29,00	45,00	15,00	21,00	0,190	
		TL-SH48-AT5-10RSB	5,00	10,00	76,42	48	1N	75,15		8,00	32,00	50,00	15,00	21,00	0,200	
		TL-SH60-AT5-10RSB	5,00	10,00	95,52	60	1N	94,25		8,00	37,00	65,00	15,00	21,00	0,310	
		TL-SH72-AT5-10RSB	5,00	10,00	114,62	72	1N	113,15		10,00	42,00	80,00	15,00	21,00	0,410	
AT5	16,00	TL-SH10-AT5-16RSB	5,00	16,00	15,92	10	1F	14,65	20,00	4,00	5,00	8,00	21,00	27,00	0,020	

PROFILE	BELT WIDTH	REFERENCE	PITCH	BELT WIDTH	PITCH DIA PD	NO. TEETH	PULLEY TYPE	OUTER DIA	A	BORE		H	F	L	WEIGHT
									mm	Min mm	Max mm				
		TL-SH12-AT5-16RSB	5,00	16,00	19,10	12	1F	17,85	23,00	4,00	7,00	12,00	21,00	27,00	0,020
		TL-SH13-AT5-16RSB	5,00	16,00	20,69	13	1F	19,45	25,00	6,00	8,00	13,00	21,00	27,00	0,020
		TL-SH14-AT5-16RSB	5,00	16,00	22,29	14	1F	21,05	26,00	6,00	9,00	14,00	21,00	27,00	0,030
		TL-SH15-AT5-16RSB	5,00	16,00	23,88	15	1F	22,65	28,00	6,00	10,00	16,00	21,00	27,00	0,030
		TL-SH16-AT5-16RSB	5,00	16,00	25,47	16	1F	24,20	32,00	6,00	11,00	18,00	21,00	27,00	0,040
		TL-SH17-AT5-16RSB	5,00	16,00	27,06	17	1F	25,80	32,00	6,00	12,00	19,00	21,00	27,00	0,040
		TL-SH18-AT5-16RSB	5,00	16,00	28,65	18	1F	27,40	32,00	6,00	13,00	20,00	21,00	27,00	0,040
		TL-SH19-AT5-16RSB	5,00	16,00	30,25	19	1F	29,00	36,00	6,00	14,00	22,00	21,00	27,00	0,050
		TL-SH20-AT5-16RSB	5,00	16,00	31,83	20	1F	30,60	36,00	6,00	15,00	23,00	21,00	27,00	0,050
		TL-SH21-AT5-16RSB	5,00	16,00	33,42	21	1F	32,20	38,00	6,00	15,00	24,00	21,00	27,00	0,050
		TL-SH22-AT5-16RSB	5,00	16,00	35,02	22	1F	33,85	38,00	6,00	15,00	24,00	21,00	27,00	0,050
		TL-SH23-AT5-16RSB	5,00	16,00	36,61	23	1F	35,40	42,00	6,00	17,00	25,00	21,00	27,00	0,070
		TL-SH24-AT5-16RSB	5,00	16,00	38,21	24	1F	37,00	44,00	6,00	17,00	26,00	21,00	27,00	0,080
		TL-SH25-AT5-16RSB	5,00	16,00	39,80	25	1F	38,60	44,00	6,00	17,00	26,00	21,00	27,00	0,080
		TL-SH26-AT5-16RSB	5,00	16,00	41,38	26	1F	40,20	44,00	6,00	17,00	26,00	21,00	27,00	0,090
		TL-SH27-AT5-16RSB	5,00	16,00	42,98	27	1F	41,80	48,00	8,00	19,00	30,00	21,00	27,00	0,090
		TL-SH28-AT5-16RSB	5,00	16,00	44,56	28	1F	43,35	48,00	8,00	20,00	32,00	21,00	27,00	0,090
		TL-SH30-AT5-16RSB	5,00	16,00	47,76	30	1F	46,55	51,00	8,00	22,00	34,00	21,00	27,00	0,110
		TL-SH32-AT5-16RSB	5,00	16,00	50,94	32	1F	49,70	54,00	8,00	24,00	38,00	21,00	27,00	0,120
		TL-SH36-AT5-16RSB	5,00	16,00	57,31	36	1F	56,05	63,00	8,00	24,00	38,00	21,00	27,00	0,160
		TL-SH38-AT5-16RSB	5,00	16,00	60,48	38	1F	59,25	66,00	8,00	26,00	40,00	21,00	27,00	0,180
		TL-SH40-AT5-16RSB	5,00	16,00	63,66	40	1F	62,45	66,00	8,00	26,00	40,00	21,00	27,00	0,190
		TL-SH42-AT5-16RSB	5,00	16,00	66,74	42	1F	65,60	71,00	8,00	26,00	40,00	21,00	27,00	0,210
		TL-SH44-AT5-16RSB	5,00	16,00	70,05	44	1N	68,80		8,00	29,00	45,00	21,00	27,00	0,230
		TL-SH45-AT5-16RSB	5,00	16,00	71,62	45	1N	70,35		8,00	29,00	45,00	21,00	27,00	0,260
		TL-SH48-AT5-16RSB	5,00	16,00	76,42	48	1N	75,15		8,00	32,00	50,00	21,00	27,00	0,280
		TL-SH60-AT5-16RSB	5,00	16,00	95,52	60	1N	94,25		8,00	37,00	65,00	21,00	27,00	0,430
		TL-SH72-AT5-16RSB	5,00	16,00	114,62	72	1N	113,15		10,00	42,00	80,00	21,00	27,00	0,410
AT5	25,00	TL-SH10-AT5-25RSB	5,00	25,00	15,92	10	1F	14,65	20,00	4,00	5,00	8,00	30,00	36,00	0,020
		TL-SH12-AT5-25RSB	5,00	25,00	19,10	12	1F	17,85	23,00	6,00	7,00	12,00	30,00	36,00	0,030
		TL-SH13-AT5-25RSB	5,00	25,00	20,69	13	1F	19,45	25,00	6,00	8,00	13,00	30,00	36,00	0,030
		TL-SH14-AT5-25RSB	5,00	25,00	22,29	14	1F	21,05	26,00	6,00	9,00	14,00	30,00	36,00	0,040
		TL-SH15-AT5-25RSB	5,00	25,00	23,88	15	1F	22,65	28,00	6,00	10,00	16,00	30,00	36,00	0,040
		TL-SH16-AT5-25RSB	5,00	25,00	25,47	16	1F	24,20	32,00	6,00	11,00	18,00	30,00	36,00	0,050
		TL-SH17-AT5-25RSB	5,00	25,00	27,06	17	1F	25,80	32,00	6,00	12,00	19,00	30,00	36,00	0,060
		TL-SH18-AT5-25RSB	5,00	25,00	28,65	18	1F	27,40	32,00	6,00	13,00	20,00	30,00	36,00	0,060
		TL-SH19-AT5-25RSB	5,00	25,00	30,25	19	1F	29,00	36,00	6,00	14,00	22,00	30,00	36,00	0,070
		TL-SH20-AT5-25RSB	5,00	25,00	31,83	20	1F	30,60	36,00	6,00	15,00	23,00	30,00	36,00	0,080
		TL-SH21-AT5-25RSB	5,00	25,00	33,42	21	1F	32,20	38,00	6,00	15,00	24,00	30,00	36,00	0,080
		TL-SH22-AT5-25RSB	5,00	25,00	35,02	22	1F	33,85	38,00	6,00	15,00	24,00	30,00	36,00	0,080
		TL-SH23-AT5-25RSB	5,00	25,00	36,61	23	1F	35,40	42,00	6,00	16,00	25,00	30,00	36,00	0,090
		TL-SH24-AT5-25RSB	5,00	25,00	38,21	24	1F	37,00	44,00	8,00	17,00	26,00	30,00	36,00	0,110
		TL-SH25-AT5-25RSB	5,00	25,00	39,80	25	1F	38,60	44,00	8,00	17,00	26,00	30,00	36,00	0,120
		TL-SH26-AT5-25RSB	5,00	25,00	41,38	26	1F	40,20	44,00	8,00	17,00	26,00	30,00	36,00	0,120

NEXT >

TYPE 1N

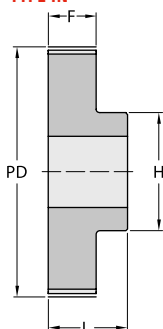

TYPE 1F

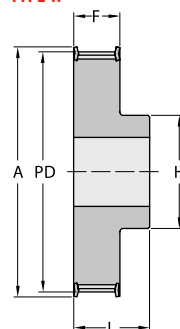

PROFILE AT5, AT10. RSB

PROFILE	BELT WIDTH	REFERENCE	PITCH	BELT WIDTH	PITCH DIA PD	NO. TEETH	PULLEY TYPE	OUTER DIA	A		BORE		H	F	L	WEIGHT
									mm	mm	Min mm	Max mm				
AT5	25,00	TL-SH27-AT5-25RSB	5,00	25,00	42,98	27	1F	41,80	48,00	8,00	19,00	30,00	30,00	36,00	0,130	
		TL-SH28-AT5-25RSB	5,00	25,00	44,56	28	1F	43,35	48,00	8,00	20,00	32,00	30,00	36,00	0,130	
		TL-SH30-AT5-25RSB	5,00	25,00	47,76	30	1F	46,55	51,00	8,00	22,00	34,00	30,00	36,00	0,150	
		TL-SH32-AT5-25RSB	5,00	25,00	50,94	32	1F	49,70	54,00	8,00	24,00	38,00	30,00	36,00	0,180	
		TL-SH36-AT5-25RSB	5,00	25,00	57,31	36	1F	56,05	63,00	8,00	24,00	38,00	30,00	36,00	0,230	
		TL-SH38-AT5-25RSB	5,00	25,00	60,48	38	1F	59,25	66,00	8,00	26,00	40,00	30,00	36,00	0,250	
		TL-SH40-AT5-25RSB	5,00	25,00	63,66	40	1F	62,45	66,00	8,00	26,00	40,00	30,00	36,00	0,280	
		TL-SH42-AT5-25RSB	5,00	25,00	66,74	42	1F	65,60	71,00	8,00	26,00	40,00	30,00	36,00	0,280	
		TL-SH44-AT5-25RSB	5,00	25,00	70,05	44	1N	68,80		8,00	29,00	45,00	30,00	36,00	0,320	
		TL-SH45-AT5-25RSB	5,00	25,00	71,62	45	1N	70,35		8,00	30,00	45,00	30,00	36,00	0,360	
		TL-SH48-AT5-25RSB	5,00	25,00	76,42	48	1N	75,15		8,00	32,00	50,00	30,00	36,00	0,400	
		TL-SH60-AT5-25RSB	5,00	25,00	95,52	60	1N	94,25		8,00	37,00	65,00	30,00	36,00	0,610	
		TL-SH72-AT5-25RSB	5,00	25,00	114,62	72	1N	113,15		10,00	42,00	80,00	30,00	36,00	0,830	
		AT10	16,00	TL-SH12-AT10-16RSB	10,00	16,00	38,20	12	1F	36,35	42,00	6,00	18,00	28,00	21,00	31,00
TL-SH14-AT10-16RSB	10,00			16,00	44,60	14	1F	42,70	48,00	8,00	21,00	32,00	21,00	31,00	0,100	
TL-SH15-AT10-16RSB	10,00			16,00	47,75	15	1F	45,90	51,00	8,00	21,00	32,00	21,00	31,00	0,120	
TL-SH16-AT10-16RSB	10,00			16,00	50,93	16	1F	49,05	54,00	8,00	23,00	35,00	21,00	31,00	0,130	
TL-SH17-AT10-16RSB	10,00			16,00	54,11	17	1F	52,25	58,00	8,00	24,00	38,00	21,00	31,00	0,150	
TL-SH18-AT10-16RSB	10,00			16,00	57,29	18	1F	55,45	60,00	8,00	26,00	40,00	21,00	31,00	0,170	
TL-SH19-AT10-16RSB	10,00			16,00	60,48	19	1F	58,65	66,00	8,00	28,00	44,00	21,00	31,00	0,190	
TL-SH20-AT10-16RSB	10,00			16,00	63,66	20	1F	61,80	66,00	8,00	30,00	46,00	21,00	31,00	0,210	
TL-SH21-AT10-16RSB	10,00			16,00	66,85	21	1F	65,00	71,00	8,00	32,00	48,00	21,00	31,00	0,230	
TL-SH22-AT10-16RSB	10,00			16,00	70,03	22	1F	68,15	75,00	8,00	34,00	52,00	21,00	31,00	0,250	
TL-SH23-AT10-16RSB	10,00			16,00	73,21	23	1F	71,35	77,00	8,00	36,00	55,00	21,00	31,00	0,270	
TL-SH24-AT10-16RSB	10,00			16,00	76,39	24	1F	74,55	83,00	8,00	38,00	58,00	21,00	31,00	0,290	
TL-SH25-AT10-16RSB	10,00			16,00	79,58	25	1F	77,75	83,00	8,00	39,00	60,00	21,00	31,00	0,310	
TL-SH26-AT10-16RSB	10,00			16,00	82,76	26	1F	80,90	87,00	8,00	39,00	60,00	21,00	31,00	0,360	
TL-SH27-AT10-16RSB	10,00			16,00	85,95	27	1F	84,10	91,00	8,00	39,00	60,00	21,00	31,00	0,360	
TL-SH28-AT10-16RSB	10,00			16,00	89,25	28	1F	87,25	93,00	8,00	39,00	60,00	21,00	31,00	0,400	
TL-SH30-AT10-16RSB	10,00			16,00	95,49	30	1F	93,65	99,00	8,00	39,00	60,00	21,00	31,00	0,440	
TL-SH32-AT10-16RSB	10,00			16,00	101,86	32	1F	100,00	106,00	10,00	42,00	65,00	21,00	31,00	0,490	
TL-SH36-AT10-16RSB	10,00			16,00	114,59	36	1F	112,75	119,00	10,00	45,00	70,00	21,00	31,00	0,630	
TL-SH38-AT10-16RSB	10,00			16,00	120,96	38	1F	119,10	125,00	10,00	48,00	75,00	21,00	31,00	0,700	
TL-SH40-AT10-16RSB	10,00			16,00	127,32	40	1F	125,45	131,00	10,00	52,00	80,00	21,00	31,00	0,770	
TL-SH42-AT10-16RSB	10,00			16,00	133,69	42	1N	131,85		10,00	57,00	80,00	21,00	31,00	0,880	
TL-SH44-AT10-16RSB	10,00			16,00	140,05	44	1N	138,20		10,00	57,00	88,00	21,00	31,00	0,990	
TL-SH45-AT10-16RSB	10,00			16,00	143,24	45	1N	141,40		16,00	59,00	90,00	21,00	31,00	1,010	
TL-SH48-AT10-16RSB	10,00			16,00	152,78	48	1N	150,95		16,00	62,00	95,00	21,00	31,00	1,090	
TL-SH60-AT10-16RSB	10,00			16,00	190,98	60	1N	189,15		16,00	72,00	110,00	21,00	31,00	1,710	
AT10	25,00	TL-SH12-AT10-25RSB	10,00	25,00	38,20	12	1F	36,40	42,00	6,00	18,00	28,00	30,00	40,00	0,100	
		TL-SH14-AT10-25RSB	10,00	25,00	44,60	14	1F	42,70	48,00	8,00	21,00	32,00	30,00	40,00	0,130	
		TL-SH15-AT10-25RSB	10,00	25,00	47,80	15	1F	45,90	51,00	8,00	21,00	32,00	30,00	40,00	0,150	
		TL-SH16-AT10-25RSB	10,00	25,00	50,90	16	1F	49,10	54,00	8,00	23,00	35,00	30,00	40,00	0,180	
		TL-SH17-AT10-25RSB	10,00	25,00	54,10	17	1F	52,20	58,00	8,00	24,00	37,00	30,00	40,00	0,200	
		TL-SH18-AT10-25RSB	10,00	25,00	57,30	18	1F	55,50	60,00	8,00	26,00	40,00	30,00	40,00	0,220	
		TL-SH19-AT10-25RSB	10,00	25,00	60,50	19	1F	58,60	66,00	8,00	28,00	44,00	30,00	40,00	0,250	
		TL-SH20-AT10-25RSB	10,00	25,00	63,70	20	1F	61,80	66,00	8,00	30,00	46,00	30,00	40,00	0,280	
		TL-SH21-AT10-25RSB	10,00	25,00	66,80	21	1F	65,00	71,00	8,00	32,00	49,00	30,00	40,00	0,310	
		TL-SH22-AT10-25RSB	10,00	25,00	70,00	22	1F	68,20	75,00	8,00	34,00	52,00	30,00	40,00	0,340	
		TL-SH23-AT10-25RSB	10,00	25,00	73,20	23	1F	71,30	77,00	8,00	36,00	55,00	30,00	40,00	0,360	
		TL-SH24-AT10-25RSB	10,00	25,00	76,40	24	1F	74,50	83,00	8,00	38,00	58,00	30,00	40,00	0,390	
TL-SH25-AT10-25RSB	10,00	25,00	79,60	25	1F	77,80	83,00	8,00	39,00	60,00	30,00	40,00	0,420			
TL-SH26-AT10-25RSB	10,00	25,00	82,80	26	1F	80,90	87,00	8,00	39,00	60,00	30,00	40,00	0,480			

NEXT >

PROFILE	BELT WIDTH	REFERENCE	PITCH	BELT WIDTH	PITCH DIA PD	NO. TEETH	PULLEY TYPE	OUTER DIA	BORE			H	F	L	WEIGHT
									A	Min mm	Max mm				
		TL-SH27-AT10-25RSB	10,00	25,00	86,00	27	1F	84,10	91,00	8,00	39,00	60,00	30,00	40,00	0,540
		TL-SH28-AT10-25RSB	10,00	25,00	89,20	28	1F	87,20	93,00	8,00	39,00	60,00	30,00	40,00	0,540
		TL-SH30-AT10-25RSB	10,00	25,00	95,50	30	1F	93,70	99,00	8,00	39,00	60,00	30,00	40,00	0,640
		TL-SH32-AT10-25RSB	10,00	25,00	101,90	32	1F	100,00	106,00	10,00	42,00	65,00	30,00	40,00	0,690
		TL-SH36-AT10-25RSB	10,00	25,00	114,60	36	1F	112,80	119,00	10,00	45,00	70,00	30,00	40,00	0,870
		TL-SH38-AT10-25RSB	10,00	25,00	121,00	38	1F	119,10	125,00	10,00	48,00	75,00	30,00	40,00	0,970
		TL-SH40-AT10-25RSB	10,00	25,00	127,30	40	1F	125,50	131,00	10,00	52,00	80,00	30,00	40,00	1,070
		TL-SH42-AT10-25RSB	10,00	25,00	133,70	42	1N	131,80		10,00	57,00	80,00	30,00	40,00	1,210
		TL-SH44-AT10-25RSB	10,00	25,00	140,10	44	1N	138,20		10,00	57,00	88,00	30,00	40,00	1,350
		TL-SH45-AT10-25RSB	10,00	25,00	143,20	45	1N	141,40		16,00	59,00	90,00	30,00	40,00	1,430
		TL-SH48-AT10-25RSB	10,00	25,00	152,80	48	1N	150,90		16,00	62,00	95,00	30,00	40,00	1,520
		TL-SH60-AT10-25RSB	10,00	25,00	191,00	60	1N	189,20		16,00	72,00	110,00	30,00	40,00	2,340
AT10	32,00	TL-SH18-AT10-32RSB	10,00	32,00	57,29	18	1F	55,45	60,00	8,00	26,00	40,00	37,00	47,00	0,250
		TL-SH19-AT10-32RSB	10,00	32,00	60,48	19	1F	58,65	66,00	8,00	28,00	44,00	37,00	47,00	0,290
		TL-SH20-AT10-32RSB	10,00	32,00	63,66	20	1F	61,80	66,00	8,00	30,00	46,00	37,00	47,00	0,320
		TL-SH21-AT10-32RSB	10,00	32,00	66,85	21	1F	65,00	71,00	8,00	32,00	49,00	37,00	47,00	0,360
		TL-SH22-AT10-32RSB	10,00	32,00	70,03	22	1F	68,15	75,00	8,00	34,00	52,00	37,00	47,00	0,390
		TL-SH23-AT10-32RSB	10,00	32,00	73,21	23	1F	71,35	77,00	8,00	36,00	55,00	37,00	47,00	0,430
		TL-SH24-AT10-32RSB	10,00	32,00	76,39	24	1F	74,55	83,00	8,00	38,00	58,00	37,00	47,00	0,480
		TL-SH25-AT10-32RSB	10,00	32,00	79,58	25	1F	77,75	83,00	8,00	39,00	60,00	37,00	47,00	0,530
		TL-SH26-AT10-32RSB	10,00	32,00	82,76	26	1F	80,90	87,00	8,00	39,00	60,00	37,00	47,00	0,560
		TL-SH27-AT10-32RSB	10,00	32,00	85,95	27	1F	84,10	91,00	8,00	39,00	60,00	37,00	47,00	0,600
		TL-SH28-AT10-32RSB	10,00	32,00	89,25	28	1F	87,25	93,00	8,00	39,00	60,00	37,00	47,00	0,640
		TL-SH30-AT10-32RSB	10,00	32,00	95,49	30	1F	93,65	99,00	8,00	39,00	60,00	37,00	47,00	0,740
		TL-SH32-AT10-32RSB	10,00	32,00	101,86	32	1F	100,00	106,00	10,00	42,00	65,00	37,00	47,00	0,840
		TL-SH35-AT10-32RSB	10,00	32,00	111,41	35	1F	109,55	115,00	10,00	45,00	70,00	37,00	47,00	0,960
		TL-SH36-AT10-32RSB	10,00	32,00	114,59	36	1F	112,75	119,00	10,00	45,00	70,00	37,00	47,00	1,080
		TL-SH38-AT10-32RSB	10,00	32,00	120,96	38	1F	119,10	125,00	10,00	48,00	75,00	37,00	47,00	1,200
		TL-SH40-AT10-32RSB	10,00	32,00	127,32	40	1F	125,45	131,00	10,00	52,00	80,00	37,00	47,00	1,320
		TL-SH42-AT10-32RSB	10,00	32,00	133,69	42	1N	131,85		10,00	57,00	80,00	37,00	47,00	1,460
		TL-SH44-AT10-32RSB	10,00	32,00	140,20	44	1N	138,20		10,00	57,00	88,00	37,00	47,00	1,610
		TL-SH45-AT10-32RSB	10,00	32,00	143,24	45	1N	141,40		10,00	59,00	90,00	37,00	47,00	1,770
		TL-SH48-AT10-32RSB	10,00	32,00	152,78	48	1N	150,95		16,00	62,00	95,00	37,00	47,00	1,930
		TL-SH54-AT10-32RSB	10,00	32,00	171,89	54	1N	170,05		16,00	66,00	100,00	37,00	47,00	2,290
		TL-SH57-AT10-32RSB	10,00	32,00	181,44	57	1N	179,60		16,00	72,00	110,00	37,00	47,00	2,640
		TL-SH60-AT10-32RSB	10,00	32,00	190,98	60	1N	189,15		16,00	72,00	110,00	37,00	47,00	3,000
AT10	50,00	TL-SH18-AT10-50RSB	10,00	50,00	57,29	18	1F	55,45	60,00	10,00	26,00	40,00	56,00	66,00	0,420
		TL-SH19-AT10-50RSB	10,00	50,00	60,48	19	1F	58,65	66,00	10,00	28,00	44,00	56,00	66,00	0,470
		TL-SH20-AT10-50RSB	10,00	50,00	63,66	20	1F	61,80	66,00	12,00	30,00	46,00	56,00	66,00	0,520
		TL-SH21-AT10-50RSB	10,00	50,00	66,85	21	1F	65,00	71,00	12,00	32,00	49,00	56,00	66,00	0,550
		TL-SH22-AT10-50RSB	10,00	50,00	70,20	22	1F	68,15	75,00	12,00	34,00	52,00	56,00	66,00	0,570
		TL-SH23-AT10-50RSB	10,00	50,00	73,21	23	1F	71,35	77,00	12,00	36,00	55,00	56,00	66,00	0,650
		TL-SH24-AT10-50RSB	10,00	50,00	76,39	24	1F	74,55	83,00	12,00	38,00	58,00	56,00	66,00	0,740

NEXT >

TYPE 1N

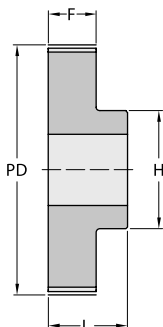

TYPE 1F

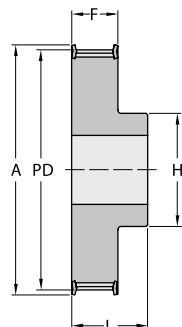

PROFILE	BELT WIDTH	REFERENCE	PITCH	BELT WIDTH	PITCH DIA PD	NO. TEETH	PULLEY TYPE	OUTER DIA	A		BORE		H	F	L	WEIGHT
									mm	Min mm	Max mm	mm				
AT10	50,00	TL-SH25-AT10-50RSB	10,00	50,00	79,58	25	1F	77,75	83,00	12,00	39,00	60,00	56,00	66,00	0,770	
		TL-SH26-AT10-50RSB	10,00	50,00	82,76	26	1F	80,90	87,00	12,00	39,00	60,00	56,00	66,00	0,820	
		TL-SH27-AT10-50RSB	10,00	50,00	85,95	27	1F	84,10	90,00	12,00	39,00	60,00	56,00	66,00	0,950	
		TL-SH28-AT10-50RSB	10,00	50,00	89,25	28	1F	87,25	93,00	12,00	39,00	60,00	56,00	66,00	0,960	
		TL-SH30-AT10-50RSB	10,00	50,00	95,49	30	1F	93,65	99,00	12,00	39,00	60,00	56,00	66,00	1,170	
		TL-SH32-AT10-50RSB	10,00	50,00	101,86	32	1F	100,00	106,00	12,00	42,00	65,00	56,00	66,00	1,300	
		TL-SH35-AT10-50RSB	10,00	50,00	111,41	35	1F	109,55	115,00	16,00	45,00	70,00	56,00	66,00	1,470	
		TL-SH36-AT10-50RSB	10,00	50,00	114,59	36	1F	112,75	119,00	16,00	45,00	70,00	56,00	66,00	1,640	
		TL-SH38-AT10-50RSB	10,00	50,00	120,96	38	1F	119,10	125,00	16,00	48,00	75,00	56,00	66,00	1,820	
		TL-SH40-AT10-50RSB	10,00	50,00	127,32	40	1F	125,45	131,00	16,00	52,00	80,00	56,00	66,00	2,000	
		TL-SH42-AT10-50RSB	10,00	50,00	133,69	42	1N	131,85		16,00	57,00	80,00	56,00	66,00	2,180	
		TL-SH44-AT10-50RSB	10,00	50,00	140,20	44	1N	138,20		16,00	57,00	88,00	56,00	66,00	2,360	
		TL-SH45-AT10-50RSB	10,00	50,00	143,24	45	1N	141,40		16,00	59,00	90,00	56,00	66,00	2,590	
		TL-SH48-AT10-50RSB	10,00	50,00	152,78	48	1N	150,95		16,00	62,00	95,00	56,00	66,00	2,830	
		TL-SH54-AT10-50RSB	10,00	50,00	171,89	54	1N	170,05		16,00	66,00	100,00	56,00	66,00	3,340	
		TL-SH57-AT10-50RSB	10,00	50,00	181,44	57	1N	179,60		16,00	72,00	110,00	56,00	66,00	3,850	
		TL-SH60-AT10-50RSB	10,00	50,00	190,98	60	1N	189,15		16,00	72,00	110,00	56,00	66,00	4,370	

TYPE 1N

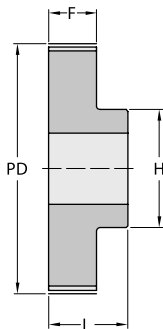

TYPE 1F

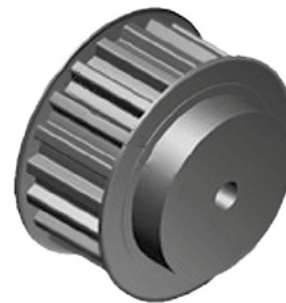
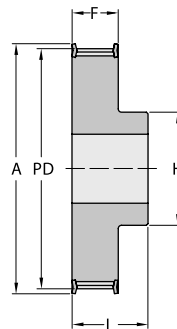

QD Timing Pulley



Idler



Idler Drive

GUIDE TO ORDER

TL - SH 64 - 14M - 170 RSB

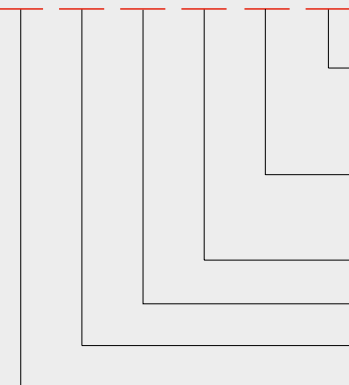

RSB: Rough Stock Bore
MPB: Minimum Plain Bore
TB: Taper Bush
QD: Quick Detach

Belt width:
 mm
 inch

Profile: According Family

Num of Teeth

SH: Pulley

Brand name